

LIBERTY-BELLE INSTRUCTION MANUAL

QUICK START

INSTALLERS

1. If you need to assembly the kiln read the ASSEMBLY section.
2. If you need to hook up the kiln red the INSTALLATION section. The Wriing diagram is located in the WIRING section.
3. Read the CAUTION section for installation cautions.

USERS

1. Read and understand the CAUTIONS section
2. Read the Operation section. This is all you need to know to operate the kiln.
3. If you want to know more about how to operate the control read the CONTROL section. This is very detailed and can be overwhelming. Use it as a reference and for more sophisticated programming and configuration instructions.
4. For ongoing routine kiln maintenance read the MAINTENANCE section. This is something that the kiln operator is responsible for.
5. For more background information on Ceramics process, Cones, and a Log Sheet see the LOG, CONES, TIPS, CERAMIC PROCESS section.

MAINTAINERS

1. Read the TROUBLESHOOTING section, the WIRING section, the PARTS section and the SERVICE & WARRANTY section.

ADMINISTRATORS

1. See the MSDS section if you have any questions about materials used in the kiln.

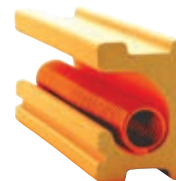

L&L Kiln's patented hard ceramic element holders protect your kiln.

CAUTION INSTRUCTIONS FOR L&L KILNS

CAUTION INSTRUCTIONS	1
KILNS THESE CAUTIONS APPLIES TO	1
RESELLERS ARE NOT AUTHORIZED TO MODIFY THESE CAUTION INSTRUCTIONS	1
DATED INFORMATION	1
SAFETY NOTICE	2
ELECTRICAL SAFETY	2
GENERAL	2
ELECTRICAL HAZARDS	2
SHOCK	2
ARC-FLASH	2
ARC-BLAST	2
SAFETY PRINCIPLES	2
INSTALLATION CAUTIONS	3
USE A QUALIFIED ELECTRICIAN	3
CLEARANCES AND FLAMMABLE SURFACES	3
CHECK TEMPERATURES AROUND KILN	3
LEVELING THE KILN	3
ADJUSTING THE HINGE PROPERLY	3
THERMOCOUPLES	4
USE THE SUPPLIED KILN STAND	4
DON'T USE AN EXTENSION CORD	4
POWER CORD MUST BE PROPERLY RATED	4
USE COPPER WIRE FOR HOOK UP	4
PROTECT POWER CORD FROM KILN CASE	4
KEEP KILN DRY & IN PROTECTED SPACE	5
KEEP A FIRE EXTINGUISHER NEAR KILN	5
SPRINKLER CAUTIONS	5
GENERAL ENVIRONMENT CAUTIONS	5
VENTILATION IS ESSENTIAL	5
AMBIENT TEMPERATURES	6
SURFACE IS HOT AND CAN CAUSE BURNS	6
KEEP CHILDREN/ANIMALS AWAY FROM KILN	6
KEEP FLAMMABLES AWAY FROM KILN	6
PRACTICE GOOD HYGIENE	6
PROPER USE OF KILN WASH	6
6. Clean off the old wash and reapply new wash each time you fire or when it begins to chip away.	6
TRIPPING HAZARDS	7
CLOTHING TO AVOID	7
PREFIRING CAUTIONS	7
KILN WASH CONTAINS SILICA	7
DO NOT USE SILICA SAND	7
NEVER FIRE MOIST GREENWARE	7
CAUTION WITH USE OF WAX	7
DO NOT FIRE TEMPERED GLASS	7
STORE SHELVES IN A DRY LOCATION	7
DO NOT USE CRACKED SHELVES	7
DO NOT FIRE TOXIC, FLAMMABLE, OR UNKNOWN MATERIALS	7
LOADING & UNLOADING CAUTIONS	8
TURN OFF POWER WHILE LOADING	8
KEEP LID CLOSED WHEN KILN IS NOT IN USE	8
DO NOT STORE ANYTHING ON LID	8
DO NOT OPEN THE DOOR ABOVE 250° F	8
DO NOT UNLOAD KILN WHILE HOT	9
BE CAREFUL OF SHARP OBJECTS & GLAZE	9
SECURE LID WHILE LOADING OR UNLOADING IF YOU HAVE A SPRING-LOADED EASY-LIFT HINGE	9
IF YOU HAVE A DAVINCI COUNTERBALANCED LID	9
IF YOU HAVE A BASIC HINGE WITH CHAIN SUPPORTS	9
VIEWING INTO THE KILN	9
FIRING CAUTIONS	10
ATTEND THE FIRING	10
MAKE SURE YOUR KILN SITTING IS ADJUSTED	10
USE KILN WASH ON THE CONE SUPPORTS	10
UNDERSTAND YOUR CONTROL	10
PROGRAM REVIEW ON AUTOMATIC KILNS	10
DO NOT CONFUSE CONE NUMBERS	10
USE THE PROPER THERMOCOUPLE	10
CHECK THERMOCOUPLE CALIBRATION	11
SHUT OFF KILN AT DISCONNECT OR CIRCUIT BREAKER	11
DO NOT FIRE KILN ABOVE 2350° F (1290° C, Cone 10)	11
POST FIRING CAUTIONS	11
CHECK FOR GLAZE AND CERAMIC CHIPS	11
GENERAL MAINTENANCE CAUTIONS	12
ELECTRICAL SAFETY	12
CHECK WIRES & TERMINALS	12
CHECK TEMPERATURE OF CORD	12
CHECK FOR CORRODED CONNECTIONS	12
THE WRONG PARTS CAN BE HAZARDOUS	12
VIDEO ABOUT GENERAL MAINTENANCE	12
KILN MODIFICATIONS CAUTIONS	13
COATINGS	13
OTHER MODIFICATIONS	13
DO NOT OVERINSULATE KILN	13

CAUTION INSTRUCTIONS

KILNS THESE CAUTIONS APPLIES TO CURRENT PRODUCTION KILNS

- Easy-Fire Kilns (e Series)
- School-Master Kilns (SM Series)
- Easy-Fire XT Kilns (eXT Series)
- Jupiter Automatic Kilns (JD Series)
- eQuad-Pro Production Kilns (eQ Series)
- JH Crystalline Kilns (JH Series)
- Hercules Front-Loading Kilns (EL-H Series)
- Easy-Load Front-Loading Kilns (EL Series)
- DaVinci Automatic Kilns (X and T Series)
- Doll/Test Kilns (DL and DLH Series)
- Liberty-Belle Kilns (LB Series)
- Fuego Kilns

OBsolete Models

- Jupiter Manual Kilns (J Series)
- Econo Kilns (K Series and J Series)
- Programmatic Kilns (B Series)
- Robin Kilns
- Dyna-Kilns (C & H Series)
- Dyna-Kilns (SQ Series)
- Dura-Fire Kilns (D Series)
- Enameling Kilns (E48, E49, R Series)
- Oval Kilns (OV Series)
- Genesis Kilns (G Series)
- Most other L&L kilns

RESELLERS ARE NOT AUTHORIZED TO MODIFY THESE CAUTION INSTRUCTIONS

Distributors and installers of L&L kilns are not authorized by L&L to make modifications or contradict these Caution Instructions (or our Installation Instructions). If L&L's instructions are not followed, L&L specifically disavows responsibility for any injury or damage that may result.

DATED INFORMATION

The information in these Caution Instructions is believed to be correct to the best of our knowledge at the time of publication (see the date at the bottom of this sheet). You can view the most recent update from our web site at hotkilns.com/cautions at any time.

CAUTION INSTRUCTIONS FOR L&L KILNS

SAFETY NOTICE

1. All cautions and requirements recommended by L&L Kiln Mfg. Inc. are meant to assist users to properly and safely operate their kilns. Many of these cautions apply to kilns and ceramic processes in general. Other process and materials are outside the scope of these Cautions. If you are firing other materials than ceramics there may be issues such as outgassing or explosive hazards that you need to carefully investigate before firing in a kiln.
2. By making use of, and/or downloading from, this web site, user acknowledges that process and manufacturing systems improperly installed, maintained, or operated can pose serious and dangerous threats to worker safety, environmental integrity, and product/process quality.
3. Kilns operate at high temperatures and make use of high voltages/amperages and if improperly installed, maintained, or used, can cause serious personal or property damages.
4. Commercial kilns are provided with various safety, performance, and operating limits, designs and devices which, if disconnected, altered, tampered with, or changed by user, user's employees, user's agents, or others acting on user's behalf or with user's knowledge, will become user's sole risk and responsibility.
5. User also has the sole responsibility for assigning properly trained persons to operate the kilns who have demonstrated common sense and a general aptitude for such work.
6. It is user's sole responsibility to understand and assure adherence to all safety notices and installation, operating, and maintenance instructions provided by L&L Kiln Mfg., Inc.

ELECTRICAL SAFETY

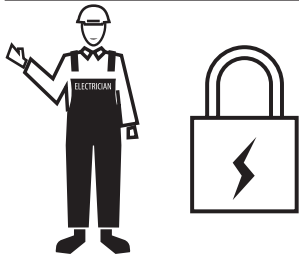

GENERAL

Electricity can be dangerous if not approached carefully. There are three basic hazards that cause injury or death – shock, arc-flash, and arc-blast. It is important to remember that even a small amount of current passing through the chest can cause death. Most deaths occurring for circuits

of less than 600 volts happen when people are working on “hot,” energized equipment – **PLEASE DISCONNECT AND LOCK OUT ALL ELECTRICAL POWER BEFORE ATTEMPTING KILN REPAIRS!**

ELECTRICAL HAZARDS



SHOCK

An electrical shock is a current that passes through the human body. Any electrical current flows through the path of least resistance towards ground; if an external voltage contacts a human body, e.g. by touching a live wire with the hand, the voltage will try to find a ground, and a current will develop that flows through the body's nervous system or vascular system, and exit through the closest part of the body to ground (e.g., the other hand which may be touching a metal pipe.) Nerve shock disrupts the body's normal electrical functions, and can stop the heart or the lungs, or both, causing severe injury or death.

ARC-FLASH

An arc-flash is an extremely high temperature conductive mixture of plasma and gases, which causes very serious burns when it comes into contact with the body, and can ignite flammable clothing. Arc temperatures reach up to 35,000°F – which is 4X the temperature of the sun's surface.

ARC-BLAST

Arc-blast is a pressure wave resulting from arcing, which can carry molten metal fragments and plasma gasses at very high speeds and distances. This can not only carry very hot shrapnel to injure a person, but can actually be strong enough to destroy structures or knock workers off ladders.

SAFETY PRINCIPLES

Be safe! Make sure any equipment that is being installed or serviced is disconnected from all sources of power. In industry, it is important to have 'Lockout and tagout' procedures in place to make sure that power stays disconnected while people are servicing equipment. It is just as important in residential and commercial sites – DO NOT

CAUTION INSTRUCTIONS FOR L&L KILNS

WORK ON LIVE EQUIPMENT UNLESS ABSOLUTELY NECESSARY!

Use the right tools for the job – do not improvise. For instance, use a proper fuse puller; don't use a screwdriver to pry out an open fuse.

Protect the person; use proper gloves, shoes, and clothing. In industry it is recommended to wear safety goggles or face shields to prevent arc-flash or arc-blast injuries. Wear rubber soled shoes.

Make sure the environment around the equipment being serviced is safe. For instance, when working around electricity, **it always very dangerous for the floor to be wet.** Make sure there is adequate space to work safely.

Be aware that current flow across your chest can be fatal. If possible, use only one hand to manipulate test leads when conducting any necessary measurements on live equipment. Use a clamp for one lead, and use one hand to guide the other test lead. Keep the other hand as far as possible from the live circuit components.

INSTALLATION CAUTIONS

USE A QUALIFIED ELECTRICIAN

1. Have electrical installation performed by an licensed electrician or other qualified technician.
2. There is danger of electric shock.
3. There is danger that an improperly sized or installed circuit could cause a fire.

CLEARANCES AND FLAMMABLE SURFACES



1. Make certain floor is not flammable.
2. Install kiln so that the hot surface of the kiln is no closer than 12" (30 cm) to any wall. 18" (46 cm) is preferable.
3. Be careful about enclosed spaces: In general, it is not a good idea to install a kiln in a small confined space (such as a closet).
4. Maintain a minimum of 36" (91 cm) between the hot surfaces of two adjacent kilns, especially if they are going to be used at the same time. (The kilns will heat each other).

5. The essential issue with kiln clearance is to keep excessive heat from flammable surfaces. Remember, even when you follow clearance and ventilation recommendations, the kiln is giving off heat. Try not to place the kiln near things that can be affected by elevated temperatures. An example would be an electrical fuse panel which you do not want to overheat.

CHECK TEMPERATURES AROUND KILN

1. Check temperatures around the kiln when it is at high fire to be sure that you are not creating an unsafe condition.
2. Combustible surfaces that stay below 71°C (160°F) are generally considered safe from the point of view of starting a fire.

LEVELING THE KILN

1. Level the kiln while you are installing it.
2. Use thin metal shims under the legs to accomplish the leveling (never wood or other combustible materials).
3. Make sure that the base will not wobble.
4. Leveling is important because the kiln sitter (in older manual kilns) is affected by gravity. If the kiln is not properly leveled the kiln sitter might be either too reactive or too sluggish.
5. You do not want your ware to be unstable in the kiln. It might fall over.
6. If kiln is not leveled this could lead to the cracking of the bottom and the top. In particular, the bottom could easily crack when you first set the weight of the kiln on the bottom while setting up the kiln for the first time.

ADJUSTING THE HINGE PROPERLY

1. See the assembly instructions for your specific kiln. (Assembly instructions are available at hotkilns.com/assembly-instructions)
2. **CAUTION: DO NOT attempt to disengage the spring hinge without first reading the detailed assembly instructions.** The spring is under great pressure and could cause severe injury if it is removed under pressure. **RELIEVE ALL SPRING TENSION BEFORE REMOVING! OPEN LID COMPLETELY!**
3. The hinge of any kiln must be adjusted so that expansion caused by the heating process has room to expand up and down. (L&L includes expansion slots in the hinges.)
4. An improperly adjusted hinge can damage the top kiln rim and/or lid by compressing and breaking the brick near the hinge.

CAUTION INSTRUCTIONS FOR L&L KILNS

5. CAUTION: It is critical that the hinge bar sits in the bottom of slot. This is to allow the lid to rise and fall slightly as the kiln heats and expands without putting stress on the lids connection points and potentially damaging the lid.

IMPORTANT CAUTION:

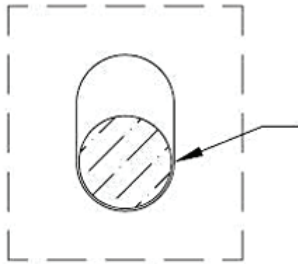

Loosen the screws and adjust the hinge bracket so that the lid lays flat on the top ring and the middle rod rests on the bottom of the elongated holes in the bracket. (As Shown)

THERMOCOUPLES

1. Thermocouples (in automatic kilns) must be inserted into the kiln at least 1" (2.5 cm) in from the inside surface of the kiln.
2. They must protrude into the kiln itself because, if the measuring tip of the thermocouple is buried inside the insulation, the thermocouple will measure a lower temperature than the actual temperature in the kiln.
3. This could cause an overfire of the kiln.
4. Replace thermocouples once they are no longer reasonably accurate. (Note: Type K thermocouples last about the same as kiln elements so it is recommended to change thermocouples when you change elements.)

USE THE SUPPLIED KILN STAND

1. Do not use kiln without the factory supplied stand.
2. Never set a kiln on a floor without significant air space circulating under the kiln.
3. L&L stands typically raise the floor of the kiln by 8" (20 cm).
4. Using a proper stand is critical because, without a kiln stand that moves the radiant heat of the kiln away from the floor, some flooring could catch on fire. For instance, over time the radiant heat from the kiln can cause wood to lose its moisture and lower the autoignition temperature. (The autoignition temperature is the specific temperature at which a substance ignites and causes a fire.)

DON'T USE AN EXTENSION CORD

1. Never use an extension cord with your kiln. The extra length of the wire could cause the cord to overheat and catch on fire.
2. Extension cords, with their multiple connections and potentially mismatched wire gauge for the load, could cause a fire when used with a continuous resistive load like a kiln.
3. Locate the outlet close enough to the kiln to plug directly into it with the kiln's supplied power cord.
4. Kilns that pull over 48 amps and some three phase kilns generally will not have a power cord. These kilns need to be direct-wired in to the power supply.

POWER CORD MUST BE PROPERLY RATED

1. All L&L power cords are rated for 105°C (221°F).
2. Any cord temperature rating less than 105°C can cause a malfunction and possible fire where the power leads connect to the control box.
3. It is OK, and will not void the warranty, to remove the plug that comes with the kiln and direct wire the kiln. However, the connection wires must be rated for a minimum of 105°C (221°F).

USE COPPER WIRE FOR HOOK UP

1. Do not use aluminum wire on the final connection to the kiln.
2. The specific reason particular to kilns is that the wire tends to get hotter near the kiln than it might going into some other types of appliance.
3. Being a resistive load, there is constant heat being generated by the conductors for quite a few hours. When aluminum wire gets hot it accelerates oxidation. Aluminum oxide is a resistor; copper oxide is not as much. If the connection at the terminal board gets oxidized it will really heat up - to the point where it could cause a fire.
4. Note: Depending on local codes it may be OK to use aluminum wire to your subpanel - as long as that wire is not exceeding its temperature rating while kiln is firing on full power for an extended period of time.

PROTECT POWER CORD FROM KILN CASE

1. Route Power Cord (or electrical connection wires) away from kiln in such a way that the wires can not touch the hot case of the kiln.
2. Secure the cord so it can not move.

CAUTION INSTRUCTIONS FOR L&L KILNS

3. If the cord touches the hot case it could melt and cause a short circuit and/or fire.

KEEP KILN DRY & IN PROTECTED SPACE

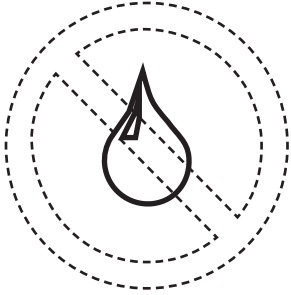

1. The kiln must be kept dry.
2. It is best to keep it in an enclosed room away from inclement weather. See specific details in the INSTALLATION INSTRUCTION section of your instruction manual or on-line at: hotkilns.com/easy-school-install or: hotkilns.com/general-installation-instructions.
3. Note that warranty does not cover damage from corrosion and electrical damage caused by inclement weather.
4. Water in contact with a kiln can cause an electrocution hazard.
5. If you keep a kiln outside (even in a very dry environment) and cover it with a tarp to protect it from rain you could still cause corrosion from the dew that forms on the cold metal surface of the kiln in the morning.

KEEP A FIRE EXTINGUISHER NEAR KILN

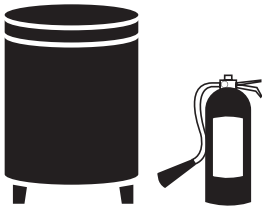

1. Keep an adequate fire extinguisher near the kiln and check it on a regular basis.
2. Check with your local fire authorities to see if there are any specific requirements concerning sprinkler systems, automatic foam extinguishers, etc.
3. Use a fire extinguisher that is rated for electrical fires (ABC rating is recommended).

SPRINKLER CAUTIONS

1. If you have a sprinkler system be careful to check the temperature rating and location of the heads so that you do not inadvertently cause them to actuate under normal firing conditions.



2. Be sure to monitor temperature while the kiln is at its highest firing temperature and conditions are at their worse (for instance when the door to the kiln room is closed or the ventilation fan is turned off). **Serious damage to the kiln and your premises can take place if the sprinkler system goes off when the kiln is at high temperature** - especially if no one is in the building when it happens.
3. See the following web page for guidance on how to calculate ventilation requirements for a kiln room: hotkilns.com/calculate-kiln-room-ventilation

GENERAL ENVIRONMENT CAUTIONS

VENTILATION IS ESSENTIAL

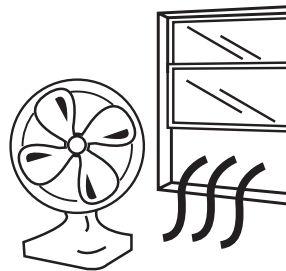

1. Kilns generate harmful fumes when firing ceramics.
2. Fumes include carbon monoxide, sulfur oxides, hydrogen fluoride and metal vapors (all of which can be very toxic).
3. Install kiln in well-ventilated area.
4. Never operate in an enclosed space such as a closet unless you have good ventilation in that space. See the following web page for guidance on how to

CAUTION INSTRUCTIONS FOR L&L KILNS

calculate ventilation requirements for a kiln room:
hotkilns.com/calculate-kiln-room-ventilation

5. Aside from issues of ventilating the fumes from the firing, the heat build up in an enclosed room could present a significant fire hazard. See the INSTALLATION cautions.
6. Severe corrosion can be caused by kiln fumes, salt air or other environmental conditions.
7. Good venting can minimize these problems.
8. Ventilation must be to the outside.
9. Be careful not to locate the outlet of the vent near an open window.

AMBIENT TEMPERATURES

1. The kiln should operate in an environment that is between -18°C (0°F) and 38°C (100°F).
2. Note that the control, if set up for degrees centigrade, may give you an error code if room temperature drops below 0°C (32°F). The DynaTrol and most other controls do not handle negative numbers.

SURFACE IS HOT AND CAN CAUSE BURNS



1. Kiln surface can be extremely hot: up to 260°C (500°F).
2. You can be severely burned if you touch the hot surface.
3. Display a sign near the kiln that specifically warns everyone of how hot the kiln is.

KEEP CHILDREN/ANIMALS AWAY FROM KILN

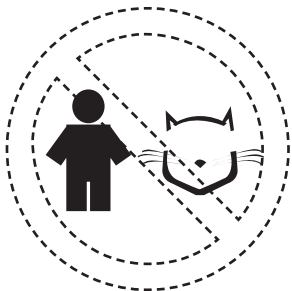

1. Protect any children, animals, and unqualified adults (anyone who is not able to understand these cautions) that may be near the kiln.

2. Aside from fumes that must be ventilated, and flammability concerns, they must be protected from the heat of the kiln and the electrical dangers.

3. Ideally, the kiln should be secured in a space away from any children (especially in a schoolroom situation where children might not always follow safety precautions).

KEEP FLAMMABLES AWAY FROM KILN



1. Do not put sealed containers or combustible materials such as solvents, paper, rags, kerosene, paints, cesium, magnesium, aluminum powder, calcium, sawdust, plastic dust, coal, flour and powdered metal., in or near kiln. An explosion or fire could result.

2. The kiln elements could act as an ignitor of flammable fumes when hot.

PRACTICE GOOD HYGIENE

1. Clay contains silica dust which can be harmful (see silica caution) and some glazes contain heavy metals such as lead, cadmium and copper.

2. While this caution is outside the scope of kiln safety it is worth mentioning here.

3. Keep your room clean and your kiln clean.

PROPER USE OF KILN WASH

1. Make sure the floor of the kiln and the tops of the shelves are coated with kiln wash.

2. This will protect these surfaces from melting glaze and ceramics.

3. Do not coat the undersides or sides of the shelves.

4. Do not apply kiln wash to the brick sides or element holders. (Damage to the elements could result).

5. If you have a kiln sitter, put kiln wash on the cone supports (not the sensing rod) for accurate cone action.

6. Clean off the old wash and reapply new wash each time you fire or when it begins to chip away.

CAUTION INSTRUCTIONS FOR L&L KILNS

TRIPPING HAZARDS

1. Be sure to remove tripping hazards near the kiln.
2. In particular be sure to keep the kiln cord out of traffic areas.

CLOTHING TO AVOID

1. When working around a hot kiln be careful of the kinds of clothes you are wearing.
2. Some clothes could potentially catch on fire if they touch the hot surface of a kiln.
3. Also avoid loose fitting clothes that could catch on the kiln.

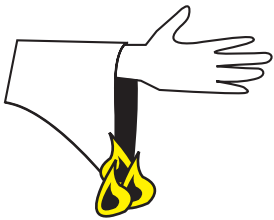

PREFIRING CAUTIONS

KILN WASH CONTAINS SILICA

1. Long term exposure to silica dust could cause lung damage.
2. See the MSDS sheets in your instruction manual or here: hotkilns.com/msds.
3. Exercise proper caution when mixing the dry powder and when removing it from your shelves.
4. Use a NIOSH approved particulate respirator for dust and use proper ventilation. You can buy these from safety supply houses. (NIOSH_approval #TC-21C-132 is an example).

DO NOT USE SILICA SAND

1. Do not use silica sand in the kiln.
2. Some people like to use this as a work support medium.
3. The silica sand will attack the elements and thermocouples.
4. It can migrate in the kiln from expansion and movement due to heat.
5. If you must use sand to support or stabilize your load try alumina oxide or zirconia oxide sand.

NEVER FIRE MOIST GREENWARE

1. Never load moist greenware or pots in your kiln.
2. The expanding water vapor in the ware could cause the ware to explode, damaging your kiln interior.

3. We recommend using a dry out segment in your bisque program at 66°C (150°F). (Note that, because of the thermocouple offset programmed into our DynaTrol when we use the ceramic protection tubes, the display temperature will read 93°C (200°F) when the real temperature is 66°C (150°F)).

4. Remember that there may be water trapped in the work even if you can't always see it. If you place a piece of greenware next to your wrist and it feels cool to the touch it probably has too much moisture in it to fire.

CAUTION WITH USE OF WAX

1. When you heat wax (in wax resist and lost wax processes) it will volatilize and potentially condense in the cooler ventilation ducts.
2. Over time this can cause a fire hazard because the wax is flammable.
3. Depending on how the vent motor is mounted, the wax can also gum up the vent motor.
4. If you use these processes it is entirely up to you to engineer and monitor the safety of the installation.
5. The use of wax will void the warranty of the vent system.

DO NOT FIRE TEMPERED GLASS

1. Tempered glass can explode when fired.

STORE SHELVES IN A DRY LOCATION

1. Shelves can absorb moisture.
2. This can cause them to explode when fired. (This is especially true of nitride bonded silicon carbide shelves).

DO NOT USE CRACKED SHELVES

1. Cracked shelves can fail in the middle of a firing causing the whole load in your kiln to collapse.

DO NOT FIRE TOXIC, FLAMMABLE, OR UNKNOWN MATERIALS

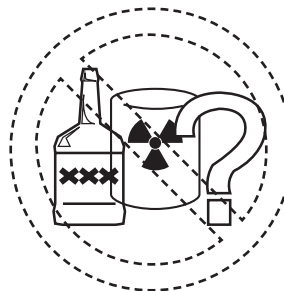

CAUTION INSTRUCTIONS FOR L&L KILNS

1. Plastics, organic materials, bakeable modeling clay, mothballs and a large variety of materials can decompose under heat causing the release of highly toxic fumes or rapid uncontrollable combustion.
2. Rocks, marbles, cement and other materials may explode under high temperatures.
3. Before firing anything but ceramics, glass and metal (obtained from a known reputable source) in a kiln carefully investigate what happens under heat.
4. This is the sole responsibility of the user.
5. The kiln is not designed to be used for firing hazardous materials. Doing so will void kiln warranty.
6. Adding propane, wood, charcoal or other materials intended to produce a reduction atmosphere can be hazardous if the volume is sufficient. Note that these materials can cause an explosion under certain conditions (just the right amount of air and flammable gasses at just the right temperature) which could cause injury or death. Moreover, a reducing atmosphere can cause premature element failure by reducing the protective oxide coating on the elements. Also note that carbonaceous materials will produce poisonous carbon monoxide and highly flammable hydrogen as they decompose at high temperatures. Also note that the "auto-ignition" temperature of flammable gasses is generally above 1400° F.

LOADING & UNLOADING CAUTIONS

TURN OFF POWER WHILE LOADING



1. Turn off power to the kiln when loading or servicing.
2. If power is on when you are loading or unloading the kiln it is possible to touch the elements and get electrocuted.
3. We recommend having the kiln attached to a fused disconnect switch with a lockout device (in any institutional or industrial installations where someone could turn on the kiln while someone else was working on it).

KEEP LID CLOSED WHEN KILN IS NOT IN USE

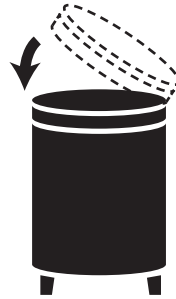

1. Keep lid closed when not operating the kiln.
2. Otherwise the weight of the lid over time may force the hinge and stainless wrap to move down.
3. This will affect the way the lid closes and may cause the lid to crack.
4. It will also keep the kiln cleaner by keeping dust out.
5. In addition, if the kiln somehow gets turned on accidentally, an open kiln could present a fire hazard.

DO NOT STORE ANYTHING ON LID

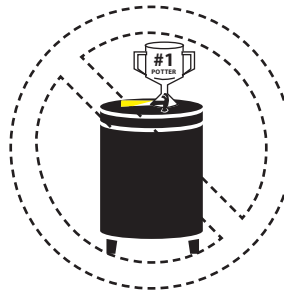

1. Do not use the lid as a storage shelf.
2. The lid could crack.
3. Also - this practice could lead to a fire if you accidentally leave combustible materials on the lid.

DO NOT OPEN THE DOOR ABOVE 250°F

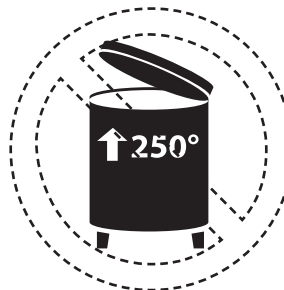

CAUTION INSTRUCTIONS FOR L&L KILNS

1. Do not open the kiln door until the kiln has cooled down to 250°F (120°C).
2. You could burn your hand on the handle and/or the radiant heat from the kiln.
3. Be careful when you do open the door at this temperature because you can still get burned.
4. Use heat resistant gloves when opening the door. (These are available from L&L).
5. For ventilation purposes, some people fire with the lid slightly propped open 1" to 3" during the beginning phase of the firing (if they do not have a downdraft vent system). **Be aware of the potential dangers of doing this (heat, live electricity, fumes and potentially cracking the lid) and take appropriate measures to protect yourself, the kiln, and the kiln room.**

DO NOT UNLOAD KILN WHILE HOT

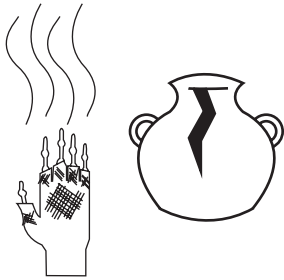

1. You may burn yourself
2. You may harm your work.

BE CAREFUL OF SHARP OBJECTS & GLAZE

1. Stilt marks and other sharp protrusions can cut you.
2. Remember that glaze is like glass.
3. Wear safety glasses while grinding or knocking of stilt marks.
4. Check the shelves for broken bits of glaze which may have attached to the shelves. These can be like shards of glass that can cause a serious cut.

SECURE LID WHILE LOADING OR UNLOADING IF YOU HAVE A SPRING-LOADED EASY-LIFT HINGE

1. Be sure to LOCK THE LID IN PLACE with the spring-loaded plunger pin located on the side of the hinge.

IF YOU HAVE A DAVINCI COUNTERBALANCED LID

1. Be sure to LOCK THE LID IN PLACE with the safety hooks when in the up position.
2. There is one on each side of a DaVinci kiln. Use both chains.

IF YOU HAVE A BASIC HINGE WITH CHAIN SUPPORTS

1. A special safety system is supplied with your Fuego, Liberty-Belle, e18S, e18T, J18, or J18X kiln (and some other older models). This is a door safety chain.
2. It secures the lid in an open position when you are loading or unloading the kiln and ensures that the lid can not accidentally come down on you. You must install and use this for your safety's sake.

This drawing shows the safety chain installation and use for the standard older Jupiter hinges.

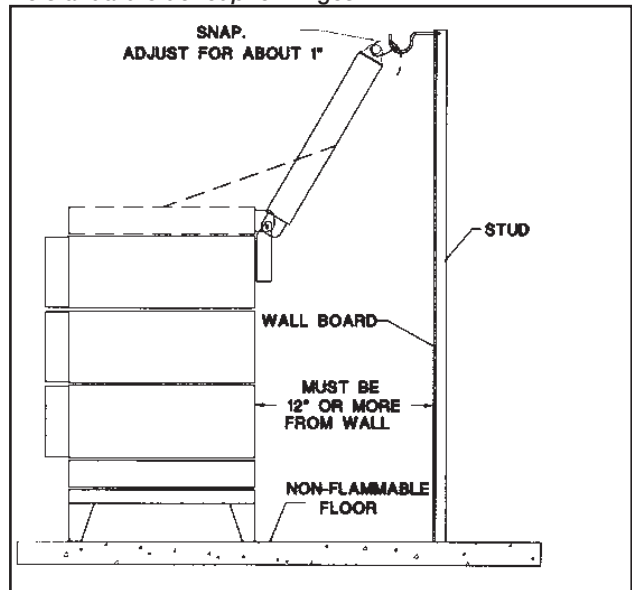

VIEWING INTO THE KILN

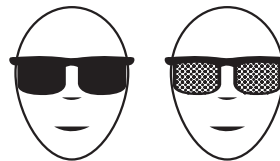

1. Use dark glasses (shade number 1.7 to 3.0) to view inside the kiln through the peepholes when firing. These will protect you from the radiant infrared radiation and will also protect your eyes in case the ceramic ware explodes. Do

CAUTION INSTRUCTIONS FOR L&L KILNS

not use regular sunglasses for this - they are not designed to protect your eyes from this type of radiation.

2. Use heat resistant gloves when opening peephole plugs. They are very hot and can burn you.
3. Do not open the kiln lid unless the kiln is turned off (except for carefully controlled troubleshooting tests). There is danger from electrocution. Cracks caused by propping open the lid are not covered by the warranty.
4. Use heat resistant gloves when opening a hot lid.
5. Do not open the lid when the kiln is above 121°C (250°F).

FIRING CAUTIONS

ATTEND THE FIRING

1. We recommend attending the kiln while firing.
2. **NO AUTOMATIC SAFETY DEVICE IS FOOLPROOF!** Be especially careful about attending the kiln when it is supposed to shut off. (The Delay feature in automatic kilns gives you control over this).
3. If you have a manual kiln with a Kiln Sitter PLEASE BE EXTRA CAREFUL! Kiln sitters can be very unreliable because of the moving parts, dirt or clay that can get into the tube, the way cones are placed on the tube, corrosion, etc. **DO NOT FIRE THIS KILN UNATTENDED WHEN THE KILN IS SUPPOSED TO TURN OFF AND LEARN HOW TO USE THE TIMER BACK UP.** Neither L&L Kiln Mfg., Inc. nor Edward Orton Jr. Ceramic Foundation warranty the kiln or kiln sitter against damage caused by overfiring. ***ALMOST ALL OVERFIRED KILNS WE SEE ARE FROM A MALFUNCTION OF A KILN SITTEER. We highly recommend firing all manual kilns with witness cones that you can see through the peephole and/or a pyrometer so you have some idea of what is happening inside the kiln.***
4. The controller is used to control temperature; it is not a safety device.

MAKE SURE YOUR KILN SITTEER IS ADJUSTED

1. If you have a manual kiln (or the Kiln Sitter backup on an automatic kiln) be sure it is properly adjusted.
2. See the Kiln Sitter instructions.
3. Overfiring could result.
4. Note that the kiln sitter could have gone out of adjustment during shipment. Do NOT assume that it is adjusted when first firing the kiln.

5. The tube assembly should be replaced if gets overly corroded or contaminated with condensed glaze or other materials. Dawson recommended checking the pivot point for corrosion and sluggishness every 6 to 12 months.

USE KILN WASH ON THE CONE SUPPORTS

1. If you have a kiln sitter, put kiln wash on the cone support (but not the sensing rod) for accurate cone action.
2. This will keep the cones from sticking when they bend.
3. We recommend cleaning off the old wash and reapply new wash each time you fire.

UNDERSTAND YOUR CONTROL

1. Become familiar with either the control (if you have an automatic kiln) or the Kiln Sitter (if you have a manual control or have that as your backup control).
2. Do this before operating the kiln.

PROGRAM REVIEW ON AUTOMATIC KILNS

1. Review the current program before firing to ensure the correct profile is programmed.
2. You may pick up an important mistake and save a whole load.
3. Hit **Review Prog** after you have done your programming and the control display will scroll through the program. It only takes a minute or less.

DO NOT CONFUSE CONE NUMBERS

1. Cone ratings are not intuitive. Cones with an "0" in front of them (like cone 05) are lower in temperature rating and the higher the number the lower the temperature rating. On the other hand cones with no "0" in front (like Cone 5) raise in temperature as the number gets higher.
2. For instance, Cone 05 is a much lower temperature than Cone 5 for instance. If you fire Cone 05 clay to Cone 5 you could cause a serious overfiring of the material which could melt in your kiln and cause severe damage to the kiln interior.
3. See the Orton cone chart. (hotkilns.com/orton-cone-chart)

USE THE PROPER THERMOCOUPLE

1. Never use a different type of thermocouple with your controller unless it has been set up from the factory (or unless you carefully go through the process of changing from one type to another).

CAUTION INSTRUCTIONS FOR L&L KILNS

2. For instance if you used a Type S thermocouple on a control set up for Type K you would overfire your kiln.
3. On some controls (like the newer DynaTrols) it is possible to change thermocouple types. However, this involves both a programming change and a jumper change on the control. It also requires you to change out all the thermocouple lead wire to properly calibrated wire for the new thermocouple type. (See: hotkilns.com/change-thermocouple-type)

CHECK THERMOCOUPLE CALIBRATION

1. Thermocouples will drift in reading over time.
2. This could potentially lead to an overfiring before the thermocouple actually fails.
3. Although you can not easily check thermocouple calibration, the general accuracy of the entire kiln system can be checked by firing with witness cones. See the LOG, CONES & CERAMIC FIRING section or hotkilns.com/troubleshooting-cones. Also see this video: hotkilns.com/firing-kiln-witness-cones.
4. **L&L recommends changing your Type K thermocouples when you change your elements.**

SHUT OFF KILN AT DISCONNECT OR CIRCUIT BREAKER

1. It is possible for electrical contacts on contactor relays to fuse together.
2. If this happens power will continue to flow to the elements and your kilns could overfire even though everything on the kiln is shut off.
3. You should turn kiln off from the circuit breaker or fused disconnect switch after turning off the kiln itself.

DO NOT FIRE KILN ABOVE 2350°F (1290°C, Cone 10)

1. Most L&L kilns are rated for use to 2350°F (1290°C, Cone 10).
2. The rating of the kiln is listed on its data nameplate normally affixed to the control panel.
3. **DO NOT FIRE ANY HIGHER THAN THIS** or hold for extended periods of time at those temperatures.
4. The elements, element holders and firebrick could melt.

POST FIRING CAUTIONS

CHECK FOR GLAZE AND CERAMIC CHIPS

1. Check element holders and walls for glaze, clay chips or anything that could melt at a high temperature.
2. If melted clay or glaze comes in contact with an element, a rapid failure could result. The molten material traps the heat radiating from the element and subsequently raises the surface temperature of the wire. The temperature will quickly pass the maximum recommended temperature for the wire and burn it.
3. To clean holders, a good shop vacuum **with a HEPA filter** will handle dust and loose crumbs. A very gentle chisel or grinder may help with glaze contamination on element holders, but remember that the elements themselves are quite brittle when they are cool.

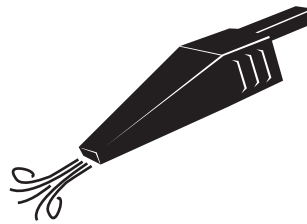

4. Replace the contaminated holder if you can not clean it.
5. Remove any glaze that has splattered on the firebrick or shelves. **(USE SAFETY GLASSES WHEN DOING THIS BECAUSE GLAZE CAN BE LIKE BROKEN GLASS).** Vacuum afterward. Note about vacuuming: it is possible to build up a strong static electricity charge when you are vacuuming. If this somehow manages to discharge into the control it can ruin the electronic circuit. Make sure vacuum is grounded and periodically touch some grounded metal surface away from the kiln to discharge the energy.

CAUTION INSTRUCTIONS FOR L&L KILNS

GENERAL MAINTENANCE CAUTIONS

ELECTRICAL SAFETY

1. Shut off kiln when servicing it. Use an approved lock out/tag out procedure to make sure that no one servicing the kiln gets injured or killed.
2. **The elements carry high voltage and can electrocute you.** Many of the tests described in the troubleshooting manual are performed under power. They should be done ONLY by someone who is familiar with electrical safety such as an electrician or trained maintenance person.
3. As long as the kiln is unplugged or turned off at the fused disconnect switch or circuit breaker (and checked with a reliable meter to be sure) you are safe.
4. **When checking element resistance, disconnect kiln from power by unplugging kiln or turning off at the fused disconnect switch or circuit breaker. Lock out if appropriate.**

CHECK WIRES & TERMINALS

1. Check wires for deterioration or oxidation or burns.
2. Replace any that seem brittle or where the wire insulation has deteriorated, fallen off or burned off.
3. Check terminals for oxidation (discoloration).
4. If you are near salt air or if you notice corrosion on the stainless exterior of the kiln for whatever reason (like certain fumes generated by your work) then do this far more frequently.
5. Check power connection terminals in the kiln and control box for tightness. Be sure to do this with the power disconnected (unplugged) for the kiln. If these terminal connections get loose heat can be generated (because the electrical resistance gets greater) and this can cause a fire.
6. Check thermocouple connections for corrosion, tightness and oxidation as well. A bad thermocouple connection can change the accuracy of the temperature reading which could cause an overfiring.

CHECK TEMPERATURE OF CORD

1. Occasionally check temperatures of the main power cord at the main receptacle and the main kiln breaker while the kiln is at its hottest.
2. If these are hotter than normal, it could be a sign of a loose or corroded connection, or possibly the wire gauge used in the power hook-up is the wrong size for the amount of current being drawn by the kiln.

3. Immediately diagnose and fix this because it could cause a fire.
4. Also check temperature of any other cords on the kilns (such as element jumper cords).

CHECK FOR CORRODED CONNECTIONS

1. When replacing infinite zone switches (and other electrical components), replace the electrical connectors.
2. At the very least check for discoloration (an indication of oxidation).
3. Electrical connectors will typically oxidize over time where there is heat and this can cause further overheating of the part at the connection point. This can in turn lead to early failure of the part, wire and connector.
4. Make certain that the new connectors are firmly crimped onto the wire.

THE WRONG PARTS CAN BE HAZARDOUS

1. **Non-L&L elements can present a potential hazard to the kiln or cause a fire (by drawing too much amperage).**
2. The wrong type of fuse, relay, switch or other component can cause a fire or other hazardous condition.
3. An improperly rated cord can cause a fire.

VIDEO ABOUT GENERAL MAINTENANCE

See this video for some general maintenance tips:
hotkilns.com/maintaining-kiln

CAUTION INSTRUCTIONS FOR L&L KILNS

KILN MODIFICATIONS CAUTIONS

COATINGS

1. We can not at this time recommend any coatings for the elements.
2. Use of ceramic coatings will void the warranty on the elements and potentially the firebrick or element holders if it contaminates them.
3. Some people have reported success with ITC coating and some people seemed to have caused problems with this coating.
4. We have not adequately tested these coatings so we can only say, at this time, that any trouble that results from the use of ITC and other coatings must be at the risk of the user.
5. We do use a proprietary coating on all our firebrick that improves firebrick life and reduces dusting.

OTHER MODIFICATIONS

1. All customer modification is made solely at the risk of the customer.
2. Modifications will void the warranty.
3. L&L takes no responsibility for hazardous conditions created by unauthorized modifications.
4. Any authorization for an engineering change must be in writing from the factory.

DO NOT OVERINSULATE KILN

1. You may add insulation to the bottom, and to some extent the top.
2. If you put too much insulation on a lid it may weaken because it relies on the cooling of the lid to maintain its structural strength. This could lead to cracking or potentially a collapse of the lid.
3. See the various troubleshooting guides for information about this.
4. However, never wrap insulation around the perimeter of a typical sectional kiln.
5. You could trap heat in the wiring boxes and cause an electrical fire.
6. Also the stainless steel wrap that hold the kiln together will expand and loosen the structure of the kiln.

LIBERTY-BELLE INSTRUCTION MANUAL

ASSEMBLY



L&L Kiln's patented
hard ceramic
element holders
protect your kiln.

ASSEMBLING YOUR L&L LIBERTY-BELLE KILN

TABLE OF CONTENTS

TOOLS NEED FOR THE JOB	1
UNPACKING	1
Inspect for visible damage	1
Unpack Instructions, Vent and Furniture Kit	1
Unpacking the kiln	2
ASSEMBLING THE STAND	3
SETTING UP THE BOTTOM	4
ASSEMBLING WITH TWO PEOPLE	5
ASSEMBLING WITH ONE PERSON	5
FINAL TOUCHES	10

TOOLS NEED FOR THE JOB

You will need the following tools for the job:

- 1) Phillips head screw driver (medium size head)
- 2) Knife
- 3) Adjustable Wrench
- 4) 3/8" Nut Driver or socket wrench
- 5) Level (not absolutely necessary)

Below is a picture of how your kiln should arrive:



UNPACKING

Inspect for visible damage

The carton should arrive without visible damage. If any carton was damaged in transit, you should either refuse shipment or unpack the kiln in the drivers presence in order to file a damage report with the freight company. **Call our office immediately if there is a problem. SAVE ALL MATERIALS UNTIL YOU ARE SURE YOU WON'T NEED THEM. AT THE VERY LEAST NOTE DAMAGE ON THE BILL- OF-LADING - WITHOUT THIS YOU HAVE NO PROTECTION!**

Unpack Instructions, Vent and Furniture Kit

- 1) Remove the corrugated pad from the inside of the carton.
- 2) For all kilns you will find the following items:
 - a) instruction manual
 - b) stand with stand legs with the assembly hardware
- 3) If you ordered a Vent-Sure vent system you will find the following items inside the cardboard insert:
 - a) flexible ductwork
 - b) bypass collection box
 - c) galvanized 90 degree elbow
 - d) vent motor with bracket that holds it to the wall

Below is a picture of the cardboard insert with a shelf kit enclosed:



ASSEMBLING YOUR L&L LIBERTY-BELLE KILN

4) If you ordered the Furniture kit you will find the following:

- a) four 15" half shelves
- b) one 15" full shelf
- c) four each 1", 2", 4", and 6" triangular posts
- d) one pound of Cone 10 kiln wash

The furniture kit:



Unpacking the kiln

With a screw driver pry off the staples holding the top and bottom box tray to the box sleeve. Take off top:



Next remove the furniture kit, stand, vent and then cardboard inset from the carton:



Remove the box sleeve from over the kiln:



ASSEMBLING YOUR L&L LIBERTY-BELLE KILN

Kiln shown with box sleeve removed:



Cut off the foam pads with a box knife:



Carefully cut off the stretch wrap that is around the kiln. Be careful not to scratch the kiln with your knife:



ASSEMBLING THE STAND

The stand consists of four legs, the stand plate and (8) 1/4-20 bolts to attach the legs to the stand. You will find all this in the top tray of the box.:

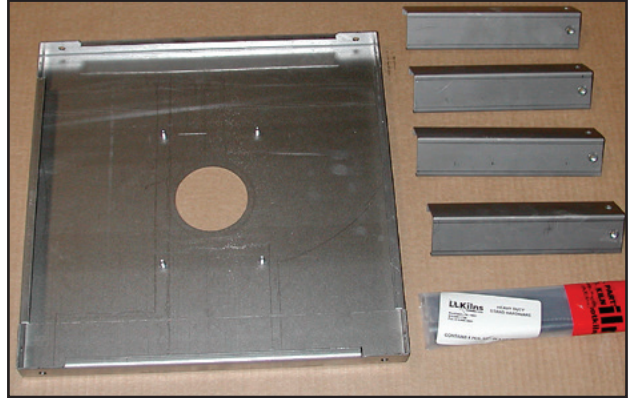

The legs get bolted to the stand with 1/4-20 bolts provided. They do not need nuts. Make sure all the stand legs are tight. Use a nut driver or an adjustable wrench to do this:



ASSEMBLING YOUR L&L LIBERTY-BELLE KILN

Fit the rubber-plastic feet over the bottom of the legs. The stand is now fully assembled:



Place the bottom of the kiln on the kiln stand. Center the bottom brick on the stand. It is not critical how the polygonal brick is oriented to the square stand:

SETTING UP THE BOTTOM

Place the stand on the floor in the desired location. This should be set so that the outside stainless steel surface of the kiln will be at least 12" to 18" from any combustible wall. Floor must be nonflammable.



NOTE: Level the kiln. Do this before proceeding because at this point it is easy to put a level on the flat bottom. Use metal shims under the legs to accomplish the leveling. We suggest using a carpenter's level for this job. **Make sure that the base will not wobble.**

Information concerning clearances, ventilation and electrical requirements is detailed in the INSTALLATION Section of this manual. Read now if you are uncertain about any of these issues. **DON'T PROCEED UNTIL YOU ARE COMFORTABLE WITH THE LOCATION THAT YOU SELECT.**

ASSEMBLING YOUR L&L LIBERTY-BELLE KILN

ASSEMBLING WITH TWO PEOPLE

If you have two reasonably strong people available you can lift the whole kiln with the two sections and the top attached without disassembling the panel. (If you have only one person - skip this section and use the single person assembly technique).

CAUTION: The two kiln sections and top together weight about 150 pounds. Be careful not to strain yourself.

Pick up the kiln using the handles on the bottom section:



Place the kiln on the bottom slab and adjust it until the bottom section matches the bottom slab:



ASSEMBLING WITH ONE PERSON

Loosen - but do not remove the four screws holding the control panel to the kiln:



Lift the panel up slightly to slip it off the two screws on the right. Let the panel hinge to the left by leaving it loosely attached to the left screws.



ASSEMBLING YOUR L&L LIBERTY-BELLE KILN

Unscrew the thermocouple wires. Notice that the red wire goes next to the thermocouple wire that is marked red.

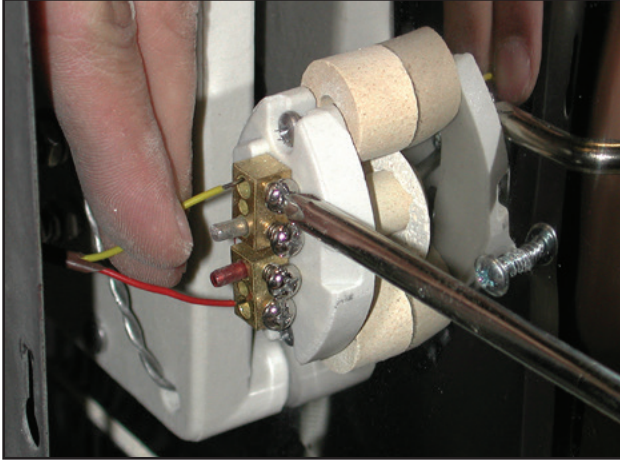

Pull element connection wires off of the Element Power Terminal:



Remove the terminal nuts on the top element terminal block so you can remove the element jumper wires that go between the two sections. Use a 3/8" nut driver or socket wrench:



Leave the Element Jumper Wires attached to the bottom section - just remove them from the top:

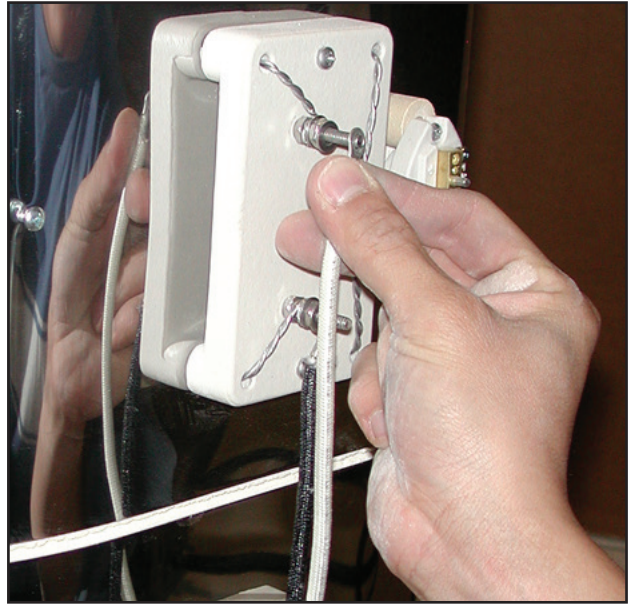

ASSEMBLING YOUR L&L LIBERTY-BELLE KILN

Element Jumper are wires shown disconnected from the top section. The Element Connection Wires that go from the top section to the panel terminal board are lying on the ground along with their connection hardware:



Now that the two sections are disconnected from each other you can lift up the top section. Place it down on the ground temporarily:



NOTE: Usually the top section along with the top is light enough that you can move it as an assembly. However, if you need to remove the top you can remove the screws that hold the support chains to the kiln and remove the hinge bar. Again - be careful of lifting too much weight.

Now you can lift up the bottom section:



Place the bottom section on the bottom slab. Line up the edges:



ASSEMBLING YOUR L&L LIBERTY-BELLE KILN

Now place the top section and top on the bottom section and make sure everything is lined up:



Reattach the Element Jumper Wires that go between the sections and attach the Element Connection Wires:



A close up showing how all the terminals of the wire and terminal hardware go together (shown before being tightened). Be sure to tighten this well because a loose connection could cause overheating at the terminal:



Hang the panel on the two left mounting screws:



ASSEMBLING YOUR L&L LIBERTY-BELLE KILN

Reconnect the thermocouple wire. **BE SURE TO CONNECT THE RED WIRE TO TERMINAL THAT HAS THE RED MARK ON THE WIRE STUB PROTRUDING FROM THE THERMOCOUPLE:**

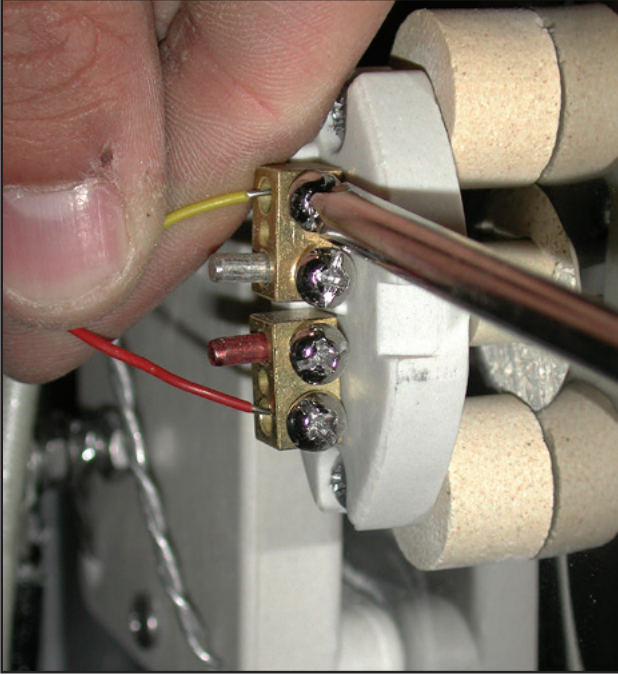

Reconnect the Element Connection Wires to the Element Power Terminal:

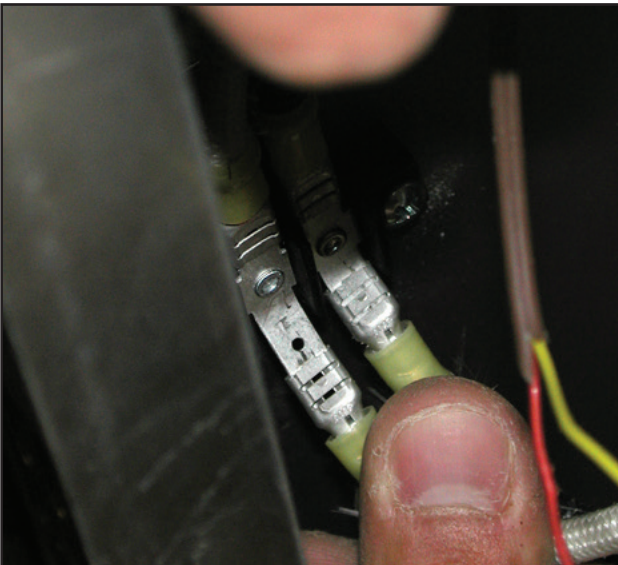

Push the panel in and slip the mounting screws (that you didn't remove) into the keyhole slots on the panel. Tighten the screws:



FINAL TOUCHES

Remove the masking tape that holds the safety chain to the lid handle:



ASSEMBLING YOUR L&L LIBERTY-BELLE KILN

Install the hook into a wall so you can attach the safety chain when the door is up:

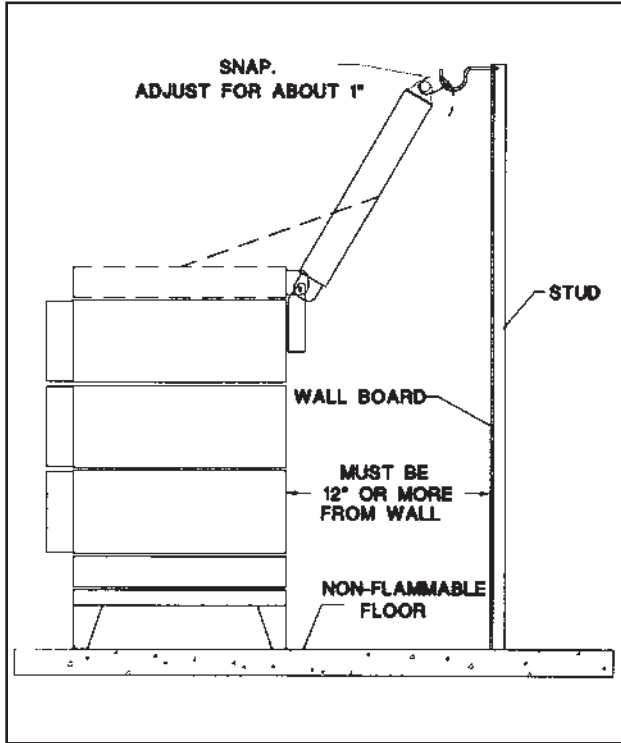

The kiln is now fully assembled and ready to plug in to a 30 amp circuit and operate:



LIBERTY-BELLE INSTRUCTION MANUAL

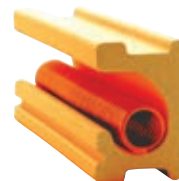

L&L Kiln's patented
hard ceramic
element holders
protect your kiln.

INSTALLING YOUR L&L LIBERTY-BELLE KILN

CODES

LOCAL CODES

Local fire and safety codes supercede information that is provided in these Installation instructions or in our Caution instructions.

UL499 LISTING

Liberty-Belle kilns are listed to UL 499 Standards for both the US and Canada by MET (An NRTL - Nationally Recognized Testing Laboratory).

NATIONAL ELECTRICAL CODE

Be sure your electrician follows the National Electric Code and any other local requirements when hooking up the kiln. One of the requirements of this code that bears particular mentioning is the fact that you must fuse your kiln appliance for 125% of its rated maximum amperage draw. This explains why you see fusing requirements in our electrical specifications that is in excess of the amperage draw of the kiln. The fuse for the kiln is either a circuit breaker or a fused disconnect switch. Note that a typical 30 amp dryer circuit, if properly constructed, meets that requirement for the LIBERTY-BELLE amperage draw.

NATIONAL FIRE PROTECTION ASSOCIATION

To the best of our knowledge, the NFPA has nothing specific about the installation of kilns. The NFPA 86 goes into considerable detail about industrial furnaces and ovens but generally with respect to internal processes and gas-fired equipment. There is one section in the NFPA 86 (Section 2-1.5 concerning Floors and Clearances) that might be construed as applicable to kilns. It requires that temperatures at combustible ceilings and floors be kept below 160°F (71°C). In general the NFPA recommends installing furnaces on noncombustible surfaces and has specific requirements if this is not possible. You can order a copy of this by going to their web site at www.nfpa.org or by calling 617-984-7249.

ELECTRICAL INSTALLATION

MOST LIBERTY-BELLE KILNS ARE 240 VOLTS

LIBERTY-BELLE kilns are wired to work on either 240 Volts, 208 Volts or (for non-US kilns sold to countries with 380 Volt power systems) 220 volts. It is important that the kiln be hooked up to the proper voltage. 208 volt kilns hooked up to 240 volt power supplies will generate too

many amps. 240 volt kilns hooked up to a 208 volt power supply will heat up about 25% slower than they should and will not reach the higher temperatures (although they would be fine for low fire in the cone 05 range).

SINGLE PHASE

All LIBERTY-BELLE kilns are single phase. This is the typical phase found in most homes. In some institutional or industrial settings you may want to hook this kiln up to a three phase power supply. Although it is possible to hook a single phase kiln to two legs of a three phase supply it will cause an unbalanced load on your electrical supply. Check with a qualified electrician to see if this is a problem in your particular circumstances. In addition to the two power wires there is a ground wire. The ground wire is not used as a neutral (i.e. no electricity normally flows through the ground). See the note about the "neutral" below.

HOOKING UP TO POWER

The LIBERTY-BELLE kiln includes a Nema 14-30P dryer plug. The circuit that the kiln runs on should be fused and rated for 30 amps. Nothing else should be running on the line while you are running the kiln.

NOTE: The Nema 14-30 plug includes a prong for the neutral. We do not use this and the prong is not wired to anything inside the kiln. We use the 14-30 plug only because that is the plug configuration that is found in most homes today for dryers.

A 12 foot long 14-30 cord is normally included. Nema 6-30 plugs with a 12 foot cord or Nema 6-50 plugs with a 6 foot or 12 foot cord may be ordered as options.

PROTECT POWER CORD FROM KILN CASE

Rout Power Cord away from kiln in such a way that it can not touch the hot case of the kiln. Secure it so it can not move. **CAUTION: If cord touches the hot case it could melt and cause a short circuit and/or fire.**

USE PROPER GROUNDING

All electrical appliances should be properly grounded. This can be to either a cold water pipe or proper system ground in your building. If there is ever a short circuit (where the electricity flows through to the case or control panel and where you might touch it) you could be electrocuted if the kiln is not grounded. An ungrounded kiln is a dangerous kiln. It is especially important with the high voltage used on kilns. The higher the voltage the more easily it could flow through your body. In addition, because of the heat

INSTALLING YOUR L&L LIBERTY-BELLE KILN

generated in a kiln, wires are subject to potential deterioration over time and expansion and contraction can move insulators and cause short circuits. Be sure to replace any deteriorated wires on wither your kiln or on the electrical circuit that you plug the kiln into.

USE ONLY COPPER WIRE

We recommend the use of copper wire for all resistance type electrical loads.

ELECTRICAL SPECIFICATIONS

All voltages are designed to be used with a 30 amp fuse.

Typical hook up wire size is 10 gauge. For long runs you may want to bump this up to 8 gauge.

All models go to Cone 10 (2350°F, 1287°C)

Volts	Amps	Watts
240	24.0	5737
208	23.9	4980
220	23.9	5267

CLEARANCES & SURFACES

CLEARANCES

Make certain floor is not flammable and install no closer than 12" to any flammable wall. (18" is preferable). Cement board, cinder blocks, brick and masonry tile are recommended wall materials near a kiln. If you have doubts check your local building codes. Keep flammable materials away from the kiln.

WALL MATERIALS

Check with local building codes for recommended non-combustible wall materials for walls that are adjacent to the kiln. Cement board, cinderblocks, and masonry tile are possible choices.

FLOORS

The Uniform Mechanical Code 2000 Edition states that "kilns shall be installed on noncombustible flooring consisting of at least two (2) inches (51 mm) of solid masonry or concrete extending at least twelve (12) inches (305 mm) beyond the base or supporting members of the kiln."

Recommended floor surfaces are cement, ceramic tile, stone, slate, cinder blocks or brick. Do not install on a wood floor or on carpet. Vinyl flooring may be combustible. Protect linoleum flooring from discoloration with a noncombustible covering. BE VERY CAREFUL ABOUT IMPLEMENTING THESE SUGGESTIONS. Remember that the kiln is putting out heat over a long period of time and that this could very well start a fire under certain conditions. Also, if an overfiring occurs, materials like glass and glazes can be super-heated and electrically conductive and they can melt right through the kiln floor. If there is a combustible floor, this could cause a fire. Also keep in mind the continued heat of the kiln can dry out combustible surfaces over time and reduce their flash point. The NFPA 86 (Section 2-1.5 concerning Floors and Clearances) that might be construed as applicable to kilns requires that temperatures at combustible ceilings and floors be kept below 160°F (71°C). In general the NFPA recommends installing furnaces on noncombustible surfaces and has specific requirements if this is not possible.

AIR CIRCULATION UNDER THE KILN

It is CRITICAL to have air circulation under the kiln. This prevents heat from being directly conducted to the floor surface. If the floor (or subfloor) is combustible a fire could result. Even if the floor is non-combustible (like solid cement) you would create a very inefficient system by placing the kiln directly on the floor. The supplied stands (which typically raise the kiln 8" from the floor) have been tested to ensure a minimum of heat transfer. It is important to use the kiln with its supplied stand. Any substitutes must be carefully tested by the user.

KILN ROOM ENVIRONMENT

KEEP KILN DRY & IN PROTECTED SPACE

The kiln must be kept dry so it must be kept in an enclosed room away from inclement weather (specifically water). The electrical circuits must not get wet. If for some reason they do get wet they must be thoroughly dried before operating the kiln. Kilns can corrode fairly rapidly if kept in rooms that have no climate control. The constant heating and cooling in an unheated shed, for instance, can cause dew to form on the cold metal and this can cause corrosion. Also exposure to salt air will accelerate corrosion dramatically. Also failure to adequately vent the kiln will allow the corrosive fumes that are generated in the firing process to corrode the metal, the wiring and even the firebrick. This sort of damage is specifically excluded from warranty coverage. We recommend the use of our Vent-Sure Vent for the Liberty-Belle kiln.

INSTALLING YOUR L&L LIBERTY-BELLE KILN

AMBIENT TEMPERATURE

Some people keep their kilns in unheated garages or sheds. This is OK as long as the room is dry. The kiln should operate in an environment that is between 0°F and 100°F.

FIRE EXTINGUISHER

We would recommend that an adequate fire extinguisher be kept near the kiln and checked on a regular basis. You may want to check with your local fire authorities to see if there are any specific requirements they have such as sprinkler systems, automatic foam extinguishers, etc. Use a fire extinguisher that is rated for electrical fires. We recommend an ABC fire extinguisher.

FIRE SPRINKLERS

If you have a fire sprinkler system position the sprinkler heads in the ceiling away from the kiln(s). The rising heat from the kiln, under normal operating conditions, could set off the sprinklers which will cause water damage. Consider using a higher temperature sprinkler head or one that is set off by smoke. Also consider using the canopy type vent system in this type of environment which will lower the temperature above the kiln. Test the installation under the worse conditions to be sure that you are not creating a hazard.

VENTILATION REQUIREMENTS

VENTILATION IS ESSENTIAL

Kilns generate harmful fumes when firing ceramics. Fumes can include carbon monoxide, formaldehyde, sulfur dioxide, heavy metal vapors, and fluorides (all of which can be very toxic). Install kiln in well-ventilated area. Never operate in an enclosed space such as a closet unless you have good ventilation. Aside from issues of ventilating the fumes from the firing, the heat build up in an enclosed room could present a significant fire hazard. Severe corrosion can be caused by kiln fumes, salt air or other environmental conditions. Good venting can minimize these problems. **Ventilation must be to the outside.** We recommend room ventilation of at least 25 cubic feet per hour.

VENTILATION FOR THE KILN

In addition, we recommend our Vent-Sure kiln vent system. This will take care of most of the venting of the fumes of the kiln and will help maintain the oxygen level in the kiln (which is important for certain glaze effects as well as good element life). See the separate Vent-Sure instructions. Vent to the outside of the building.

CARBON MONOXIDE MONITORING

We recommend the use of a carbon monoxide monitor in your kiln room.

BTU ANALYSIS FOR L&L LIBERTY-BELLE KILNS FOR HVAC CALCULATIONS

These tables can be used to calculate maximum BTU output into a room when firing a kiln at various temperatures. It is meant for HVAC calculations.

The following table is for Liberty-Belle kilns with 2-1/2" thick brick:

MODEL NUMBER	INTERIOR DIMENSIONS		CUBIC FEET	K.W	Total Internal Sq Feet	Total Internal Sq Inches	Watts per internal Sq Inch	Total BTU loss/Hr at 1800F	Total BTU loss/Hr at 2000F	Total BTU loss/Hr at 2350F
	DIAM	HIGH								
LB18	17 1/2	18	2.6	5.5	10.8	1552	3.54	6723	7876	9772

BTU'S HEAT LOSS PER SQ FT PER HOUR AT 1800 DEGF: 624 BTU's per Square Foot per hour with 2-1/2" brick
 BTU'S HEAT LOSS PER SQ FT PER HOUR AT 2000 DEGF: 731 BTU's per Square Foot per hour with 2-1/2" brick
 BTU'S HEAT LOSS PER SQ FT PER HOUR AT 22350 DEGF: 907 BTU's per Square Foot per hour with 2-1/2" brick

The following table is for Liberty-Belle kilns with 3" thick brick:

MODEL NUMBER	INTERIOR DIMENSIONS		CUBIC FEET	K.W	Total Internal Sq Feet	Total Internal Sq Inches	Watts per internal Sq Inch	Total BTU loss/Hr at 1800F	Total BTU loss/Hr at 2000F	Total BTU loss/Hr at 2350F
	DIAM	HIGH								
LB18-3	16 1/2	18	2.5	5.5	10.6	1523	3.61	5561	6502	8067

BTU'S HEAT LOSS PER SQ FT PER HOUR AT 1800 DEGF: 526 BTU's per Square Foot per hour with 3" brick
 BTU'S HEAT LOSS PER SQ FT PER HOUR AT 2000 DEGF: 615 BTU's per Square Foot per hour with 3" brick
 BTU'S HEAT LOSS PER SQ FT PER HOUR AT 22350 DEGF: 763 BTU's per Square Foot per hour with 3" brick

LIBERTY-BELLE INSTRUCTION MANUAL

WIRING

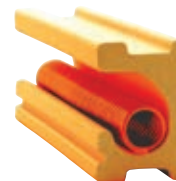

L&L Kiln's patented
hard ceramic
element holders
protect your kiln.

NOTES:

Control Wire:
16 AWG, 105°C
Power Wire:
10 AWG, 150°C

Industrial & commercial applications may require the installation of a LOCKOUT/TAGOUT device to prevent the Kiln from operating during maintenance.

This Kiln is recommended to be wired & connected to an approved U. L. & NEC configured receptacle controlled with a disconnect switch and properly fused according to the KW load specification listed on the Kiln Nameplate. L&L Kiln Mfg., Inc., also recommends fuses rather than circuit breakers to prevent nuisance tripping.

Note: Neutral Not Used

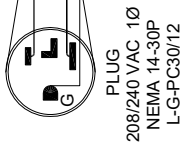

SAFETY SWITCH BY CUSTOMER

Connect to
240 Volt, 2 Wire, Single Phase - or
220 Volt, 2 Wire, Single Phase - or
208 Volt, 2 Wire, Single Phase
50 or 60 Cycles.

LOOKING INSIDE CONTROL PANEL

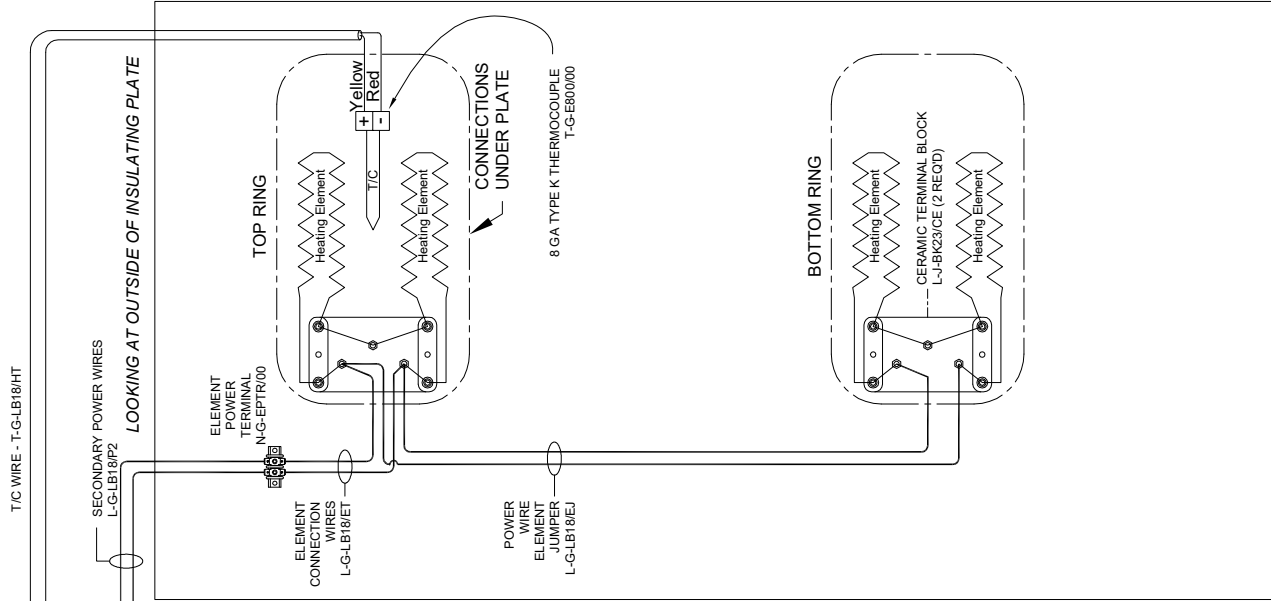
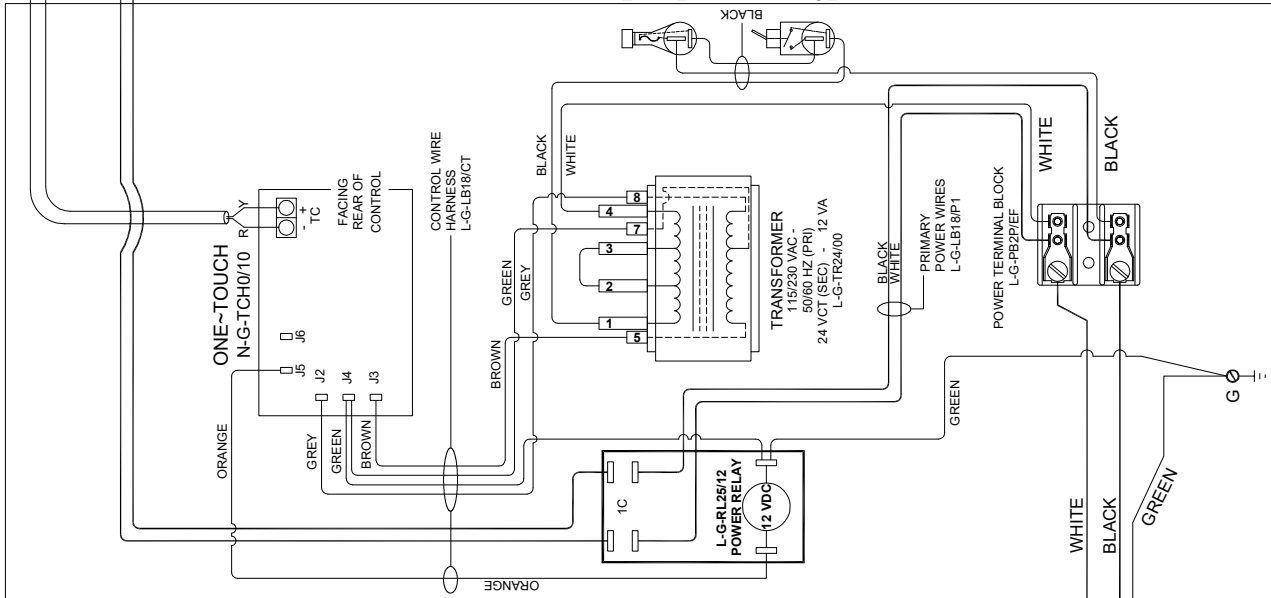

**Model LB18
208 Volts**

VOLTAGE	208 / 1 / 50-60
WATTS	4992
FULL LOAD AMPS	L1 L2 L3 24.0 24.0
POWER SUPPLY	FUSE WIRE 30A 10 AWG
ELEMENTS	QTY OHMS 4 8.3

**Model LB18
220 Volts**

VOLTAGE	220 / 1 / 50-60
WATTS	5280
FULL LOAD AMPS	L1 L2 L3 24.0 24.0
POWER SUPPLY	FUSE WIRE 30A 10 AWG
ELEMENTS	QTY OHMS 4 8.8

**Model LB18
240 Volts**

VOLTAGE	240 / 1 / 50-60
WATTS	5760
FULL LOAD AMPS	L1 L2 L3 24.0 24.0
POWER SUPPLY	FUSE WIRE 30A 10 AWG
ELEMENTS	QTY OHMS 4 9.6



D	11/5/07	UPDATED WIRING COLORS AND CONTROL REFERENCE LABELS
C	8/4/02	Updated to Quad
B	7/31/01	UPDATED AMPERAGE, WATTAGE VALUES, MET CERTIFICATION
A	7/30/00	ADDED NEW LOGO
0	11/03/00	FIRST ISSUE
REV.#	DATE	REVISION DESCRIPTION

DRAWING NO.	K213-151	SHEET OF	1/1	REV	D	TITLE	MODEL LB18 LIBERTY BELLE KILN 1 PHASE WIRING DIAGRAM (Regular or Quad)	SCALE	1 = 8	DATE	11/5/03	DRAWN BY	G.D.L.	FILE NAME	IK213-151.DWG	MADE FROM	NEW
-------------	----------	----------	-----	-----	---	-------	---	-------	-------	------	---------	----------	--------	-----------	---------------	-----------	-----

505 SHARPTOWN RD.
SWEDENBORO, NJ 08065
PHONE: (856) 294-0077
FAX: (856) 294-0070
L&L Kilns
hoktiline.com

LIBERTY-BELLE INSTRUCTION MANUAL



L&L Kiln's patented
hard ceramic
element holders
protect your kiln.

INDUSTRIAL GRADE CERAMIC THERMOCOUPLE PROTECTION TUBES

A standard 8 gauge Type K Thermocouple:



The ceramic mullite protection tube it goes in:



ADVANTAGES

1. Longer life than the metallic sheathed thermocouples or exposed thermocouples.
2. No metal spalling in the kiln.
3. Protection from contamination found in clay such as sulfur.
4. Cheaper replacement cost for thermocouples.

SAVE MONEY ON TC REPLACEMENTS

One major advantage of these protection tubes is that you can replace your old thermocouples with the cheaper standard 8 gauge thermocouples without changing the protection tube. A replacement 8 gauge thermocouple is less expensive than the metal-sheathed thermocouples. Over time the protection tubes may have to be replaced if they get contaminated from materials in the kiln; however, it should take a long time for contaminants to leach through the relatively impervious 1/8" thick mullite tube. The tube can be easily replaced independently from the thermocouples - they are not sealed or cemented together.

SIZE AND DESCRIPTION

The protection tubes are 3/4" in outside diameter with a 1/2" inside diameter (which accommodates the standard 8 gauge Type K thermocouple). There is a flange on the back end of the thermocouple to prevent it from going into the kiln. If you are retrofitting an older kiln you will have to drill out the brick to 3/4". This is no problem. In fact the stainless steel where the thermocouples go through is, in most cases, punched at 1" diameter.

L&L TEST PROGRAM

The industrial 2300mi thermocouples that had been used for several years are no longer available because Hoskins, who made the material, is no longer in business. This is L&L's careful response to this issue.

Mullite ceramic protection tubes over 8 gauge type k thermocouples offer superior life than 2300mi thermocouples.

L&L tested 23 different thermocouples in a kiln by firing them to Cone 10 (2350°F) and soaking the kiln for one hour repeatedly and then measuring the thermocouples with a sophisticated datalogger. The main thermocouple to control the kiln was a platinum Type S. The various test thermocouples were our standard 8 gauge thermocouple with a butt-welded end, one with a twisted end, both in a heavy mullite protection tube and exposed to air, 14 gauge Type K exposed thermocouples, Type N thermocouples of various types, a Hoskins 2300mi, several metallic sheathed thermocouples with Inconel and various grades of Pyrocil (the replacement for the 2300mi), etc.

One of our standard Type K 8 gauge thermocouples in the industrial protection tube achieved 139 firings. The standard 8 gauge thermocouple without a protection tube made it to 100 firings. The metal-sheathed Pyrocil was good but not as good as the 8 gauge with the protection tube (it worked for 130 firings). An 8 gauge Type N did slightly better (143 firings) but the potential confusion of using this outweighed the simplicity and backward compatibility of the Type K.

The conclusion from the test is that a standard 8 gauge thermocouple with an industrial mullite ceramic protection tube offered the best combination for cost of replacement, cleanliness (there is no contamination of the kiln with metal spalling), resistance to contaminants in the kiln like sulfur, backward compatibility, and long life.

INDUSTRIAL GRADE CERAMIC THERMOCOUPLE PROTECTION TUBES

The kiln the thermocouples were tested in, before and after the test:

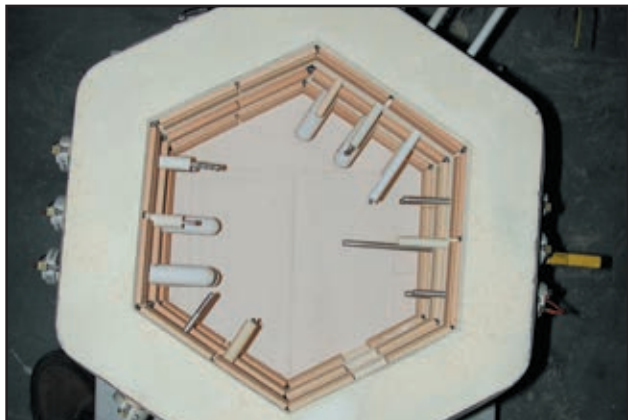

THERMOCOUPLE & CONE OFFSETS

A thermocouple in a protection tube has a slightly delayed response and hence an offset from a more sensitive thermocouple like the metallic sheathed thermocouple. However, our test indicated that every thermocouple measured slightly different temperatures anyway. A detailed analysis of responses after about 130 firings showed the 8-gauge Type K thermocouple in the protection tube to be between the control Type S platinum thermocouple and the metallic sheathed Pyrocil Type K. In any case the DynaTrol control has thermocouple offsets and cone offsets to allow you to compensate for any such effects. For ceramic work we recommend calibrating the kiln performance with cones and adjusting the control to match the performance of the firing cones. The most important thing is to get a consistent reading from the thermocouples. In a separate series of tests in our Easy-Fire kilns we came up with the exact offsets that seemed to work time and again. We ran various Easy-Fire cone programs on the DynaTrol with

various offsets programmed into the control and measured accuracy of results with Large Self-Supporting Cones. The “Blue” DynaTrol (in use since April 2003) comes with these Thermocouple Offsets and Cone Offsets preprogrammed. From cone 022 to cone 017 the cone offsets are set at 9020. All other cones are preset at 0000. The Thermocouple Offset comes programmed into the control at 0018 (+18°F) when it leaves the factory. Note the room temperature will show around 90°F to 100°F. You can easily program these settings into the older “Green” DynaTrol. If you do not use the thermocouple protection tubes then you need to change thermocouple and cone offsets to 0000. See [dynatrol-basic-operation.pdf](#) in the OPERATION section for more information on calibration. (Note that we used a greater offset from April 2003 to Oct 2004 because the protection tubes were not as sensitive as the ones we currently use.)

METALLIC PYROCIL TC OPTION

For those who prefer the metal-sheathed thermocouples for greater sensitivity they are available by special order.

See the separate PDF file on this:

hotkilns.com/metallic-tc

TYPE S PLATINUM THERMOCOUPLES FOR L&L KILNS

THE BEST THERMOCOUPLE

The standard thermocouple used on the DynaTrol is Type K. The most common thermocouple configuration that we use is an 8 gauge exposed Type K thermocouple protected with a mullite ceramic protection tube (standard on Easy-fire, Easy-Fire XT, School-Master, Jupiter, eQuad-Pro, Hercules, Easy-Load, DaVinci, Liberty-Belle and Doll kilns).

The very best thermocouple for constant high fire applications is a Type S platinum thermocouple with an alumina sheath. This is standard on the JH Series kilns and is recommended for the most extreme conditions (like firing crystalline glazes). You can special order a DynaTrol with Type S thermocouples. The control is hard programmed for this (to avoid potential misfiring) and special calibrated wire connects the platinum thermocouples with the control.

Below is Type S Platinum Thermocouple:



TECHNICAL INFORMATION

Type S thermocouples are composed of a positive leg which is 90% platinum and 10% Rhodium, and a negative leg which is 100% platinum. It is usable from 32°F to 2700°F. (0°C to 1480°C). It has a different EMF output than Type K thermocouples (meaning the same temperature will produce different voltages to the control which must then be interpreted differently).

At temperatures used in pottery kilns (even the highest 2400°F) these thermocouples can last for a very long time (as long as they are not mechanically broken).

The lead wires that go from the Type S thermocouple to the control are a special grade that is not interchangeable with Type K lead wire.

On DynaTrols used before Jan 1, 2006 this is not a retrofittable option.

On DynaTrol 700 controls (used after Jan 1, 2006) the control can be easily converted from Type K to Type S in

the field. You will still need to change the lead wire. Contact L&L for more information.

DESCRIPTION

The Type S thermocouples that we provide have a 5/16" OD alumina sheath. They are ungrounded. There are three lengths. The short one used in the Easy-fire, Easy-Fire XT, Jupiter, eQuad-Pro, JH Series, DaVinci, and Doll kilns is 120 mm (4.75") long. The medium one used in the Hercules and Easy-Load front-loading kilns is 160 mm long (6.3"). There is a special order extra long one used in the discontinued Renaissance front-loading kilns which is 220 mm long (8.66"). Termination is in the ceramic terminal block.

ORDERING

PART NUMBER: T-G-SXXX/00

Type-S Thermocouple - 120 mm (Standard Length).

Type S Platinum Thermocouple with Alumina Protection Tube and Terminal Block - Unit is 120 mm (4-3/4") Long x 1/4" Diameter. Can be used on any polygonal, square, or rectangular kilns with standard 2-1/2" or 3" brick insulation using a DynaTrol control board. Not for use on any Front-Loading kilns, or custom kilns with more than 3" of insulation. Nor for use with any kilns not using a DynaTrol or Genesis control board.

hotkilns.com/type-s-thermocouple-standard

PART NUMBER: T-G-SXXX/06

Type-S Thermocouple - 160 mm (Medium length).

Type S Platinum Thermocouple with Alumina Protection Tube and Terminal Block - Unit is 160 mm (6-5/16") Long x 1/4" Diameter. Used on Hercules and Easy-Load kilns where wall thickness is 5".

hotkilns.com/type-s-thermocouple-long

NOTE: Type S thermocouples can be ordered with a kiln as part of the original equipment on all kilns that have a DynaTrol or Genesis Control.

INDUSTRIAL METAL SHEATHED THERMOCOUPLES FOR L&L KILNS

METAL SHEATHED THERMOCOUPLES ON L&L KILNS

The standard thermocouple used on the DynaTrol is Type K. The most common thermocouple configuration that we use is an 8 gauge exposed Type K thermocouple protected with a mullite ceramic protection tube (standard on Easy-fire, Easy-Fire XT, School-Master, Jupiter, eQuad-Pro, Hercules, Easy-Load, DaVinci, Liberty-Belle and Doll kilns).

An alternative to the standard 8 gauge thermocouple is the Type K industrial Pyrocoil metal-sheathed thermocouples. You can special order an Easy-fire, Easy-Fire XT, Jupiter, eQuad-Pro, Hercules, Easy-Load, DaVinci, or Doll kiln with Type K pyrocoil thermocouples in place of the 8 gauge Type K thermocouple.

Below is metallic sheathed Pyrocoil thermocouple:



APPLICATION

These thermocouples are useful where greater responsiveness is required than you will get with the 8 gauge inside of a 1/8" wall thickness ceramic protection tube. This is typically for industrial applications. Most ceramic firing does not need quick response.

We do not recommend using these above cone 6 temperatures (2232°F, 1222°C).

Based on our life testing the pyrocoil sheathed thermocouples got about 130 cone 10 firings vs. the 139 cone 10 firings of the 8 gauge thermocouple with the industrial mullite protection tube (a 100 firings for an exposed 8 gauge thermocouple).

DESCRIPTION

Industrial Grade Pyrocoil Metal Sheathed Thermocouples are made with a high temperature alloy called Pyrocoil.

L&L provides these special thermocouples with a 1/4" diameter sheath. These will last longer than the smaller 1/8" diameter thermocouples that some manufactures use. We use a high quality ceramic terminal block on the end.

The standard Pyrocoil thermocouple is 6-1/2" long.

Because the Pyrocoil thermocouples are still Type K, no changes need to be made with the control board to use them.

THERMOCOUPLE OFFSET

The typical thermocouple offset of +18 Deg F is NOT used with these Pyrocoil thermocouples. The thermocouple offset is initially set for 0 Deg.

ORDERING

PART NUMBER: T-G-E23M/05

Type-K Industrial Grade Pyrocoil Sheathed Thermocouples with Ceramic Terminal Block - Unit is 5" Long x 1/4" Diameter. Used on DaVinci, Jupiter, Easy-Fire and other kilns with 2-1/2" or 3" brick walls.

hotkilns.com/type-k-pyrocoil-sheathed-thermocouple-5-long

PART NUMBER: T-G-E23M/06

Type-K Industrial Grade Pyrocoil Sheathed Thermocouples with Ceramic Terminal Block - Unit is 6-1/2" Long x 1/4" Diameter. Used on Hercules and Easy-Load kilns where the wall has a thickness is 5" of insulation.

hotkilns.com/type-k-pyrocoil-sheathed-thermocouple

NOTE: Pyrocoil thermocouples can be ordered with a kiln as part of the original equipment.

LIBERTY-BELLE INSTRUCTION MANUAL

VENT



L&L Kiln's patented
hard ceramic
element holders
protect your kiln.

Vent-Sure Downdraft Vent

Downdraft Vent for L&L Kilns

Features & Benefits

Type of Vent: Downdraft - pulls air from the bottom of a kiln to ventilate fumes from the kiln under vacuum. Vents kiln fumes to the outside. The Vent-Sure downdraft ventilation system produces better firing by promoting higher temperature uniformity in the kiln - up to a 1/2 cone improvement.

Voltage and Amperage: 120 Volts at 1.37 Amps.

On/Off Switch and Cord: Switch on six foot cord (120 volt models only).

Blower Mounting: Blower is normally mounted on the wall with discharge through a 4" round opening. (See Options below for optional Multi-mount bracket). This keeps the heat of the kiln away from the motor (for long motor life) and keeps the motor vibration away from the kiln (which can cause ware to move, damage to the kiln, and misfiring of cones on a kiln sitter). Although the vent motor normally discharges right through the wall it is mounted on, use of 4" duct can extend this distance 60 feet (horizontally or vertically) with up to four 90 degree bends.

Duct Work: 15 Feet of 3" flexible and expandable duct is included along with necessary hose clamps. Longer lengths or lengths of 3" stove pipe can be used as well.

Capacity: The blower vents up to 130 cfm (cubic feet per minute). This will handle up to a 20 cubic foot kiln (and usually larger) or even two separate kilns. More than one vent can be attached to larger kilns.

Vent Control: A vacuum bypass on the kiln bypass/collection box adjusts the amount of venting from the system.

Warranty: Limited 3 year warranty. (hotkilns.com/warranty).

UL Listing: The Vent-Sure is c-MET-us listed to UL499 standards for use with Easy-Fire, Jupiter, Liberty-Belle, and DaVinci kilns. It is MET-us listed to UL499 standards for use with Hercules and Easy-Load kilns.

P/N for standard 120 Volts: M-V-VENT/00

Options

Multi-Mounting Bracket (M-V-MULT/00):

An adapter to mount the vent motor on the floor or point the outlet vertically for ceiling installations.



The Multi-Mounting Bracket

Vent Control (M-V-CNTL/00):

The Vent Control will allow you to program the vent motor to turn on and off during the firing cycle with your DynaTrol or Genesis control.

220-240 Volt Option (M-V-VENT/EU): Motor is 220 volt. Plug to be specified.

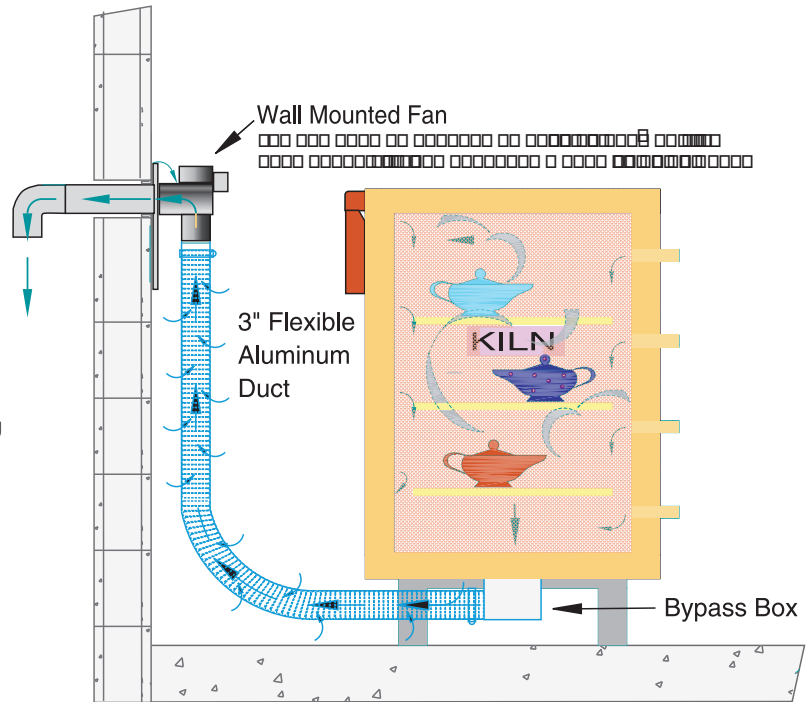

The Vent-Sure pulls air out of the kiln and the room keeping fumes in the duct under vacuum so any leaks get pulled out instead of pushed into your room. The Vent-Sure is the worry-free, super-safe vent!

Vent Doubler (M-V-VENT/DB): The Vent-Doubler allows you to connect two kilns to a Vent-Sure vent system. This can be added to an existing vent system or ordered with a new vent. In some cases you may

be able to fire two kilns at once. The Vent-Sure has enough force to vent at least 20 cubic feet of kiln. The "T" duct fitting attaches to the inlet of the fan motor. There are two dampers on it to allow you to both control the flow and to shut off one or the other kiln. Flexible aluminum duct connects this "T" duct and the two fittings that attach to the kiln stands. (Note: The Multi-Mount Bracket (M-V-MULT/00) is shown but not included with the VentDoubler. Order separately.)

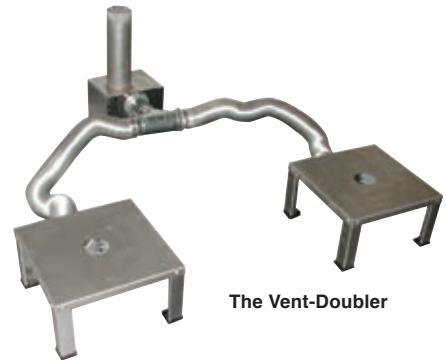

The Vent-Doubler



505 Sharptown Road • Swedesboro, NJ 08085
 Phone: 856.294.0077 • Fax: 856.294.0070
 sales@hotkilns.com • hotkilns.com

KILNS BUILT TO LAST

Bulletin No: VS-11-17

Vent-Sure Downdraft Vent

Frequently Asked Questions

How do I know if the system is working?

The easiest way to test the operation of the vent system is to turn the unit on and to place a lit match directly over and level with one of the holes in the bottom of the kiln. The flame from the match should be gently pulled into the kiln as a result of the draft.

How hot does the duct get during the firing?

Due to the introduction of fresh air through the plenum of the vent system mixing with the hot gases being drawn from the kiln, the temperature of the duct is below 150oF. This will prevent burns from occurring in the event of the duct being touched.

How long can the duct be and with many bends?

Up to 60 feet of ducting containing four 90 degree bends may be safely used with no drop in static air flow at the duct exhaust point or a reduction in draw at the kiln. The ducting can be run either horizontally or vertically.

Do I need double wall duct when going through the roof?

You do not normally need double wall ducting when going through the roof since the pipe or duct does not reach high temperature. It is always advisable to check your local building codes for their requirements.

What type of duct do I use if I need more than 15 feet?

You can use more of the flexible aluminum dryer ducting or you can use galvanized furnace ducting. We recommend using 4" diameter galvanized duct.

Will the fumes coming through the vent damage my plants, the neighborhood pets or disturb the local environment?

No. The fumes and the gases coming from the kiln have been diluted with enough fresh air to make them safe for the environment. Do not, however, place the outlet of the vent below an open window.

Will using the vent cause my firing to take longer?

The vent system pulls only a very small amount of air out of the kiln, so very little heat is removed and firing times will change very little. For some kilns, a high firing may take a little longer. The insulation value and the number of air leaks in the kiln also determine the length of the firing. We have seen vents overpower smaller kilns - so it is important to adjust the amount of venting in some cases. On the other hand an example of an e23T seven cubic foot kiln firing an 85 pound load on Fast Glaze program to cone 8 took 7 hours and 4 minutes with a vent on and 6 hours and 24 minutes without a vent. The vent was on the whole time.

What does it cost to operate the vent system?

The vent system typically costs less than 1 cent/hour to operate (electricity costs). Vent systems save on heating and cooling costs when compared to hoods. Hoods remove massive amounts of air from the kiln room - air that may have been heated or cooled, depending on the time of year. Downdraft type vents remove 80% less air in the kiln room than a hood. (It does cost more to run the vent because it does take heat out of the kiln. For instance an e23T in the example above took 70 KW hours with a vent on and 62 KW hours without a vent. At 8 cents per KW hour that would be a cost of \$0.64. The vent was on the whole time).

Will the cold air entering the kiln damage the product?

The amount of air that is entering the kiln is so small that it does not cause problems with the ware. The top holes are placed toward the outside of the chamber area so that no air comes down directly onto ware that is placed near the top of the kiln. (L&L NOTE: This is fine but we do not normally recommend holes in the lid - a kiln is porous enough).

Will faster cooling crack the ware if I leave the vent on during the cooling Cycle?

No. Some kilns can cool an average of 4-1/2 hours faster with the use of the vent system. The cooling is faster but it is taking place at an even rate throughout the kiln avoiding uneven stresses being placed on the ware. Most ceramic ware can be cooled more quickly if the cooling takes place at an even rate. The rate of cooling increase will depend on the kiln size and the density of the load. The vent will remove more molecules of air and hence heat as the kiln cools. This is because the density of the air increases the lower in temperature you go. This is one reason why kiln vents are so efficient - they don't remove too much heat when you don't want them too at the higher temperatures).

What should I do if I still smell fumes?

You should check your duct work to make sure it is properly connected and that the joints are sealed. You can also check for extra air leaks around your kiln and repair these if necessary.

Note: These Frequently Asked Questions are provided courtesy of The Edward Orton Jr. Ceramic Foundation with some modification based on our Vent-Sure vent system and experience.



This shows several small kilns hooked up with one Vent-Sure using two Vent-Doublers. (Up to 20 cubic feet can be ventilated with one vent).

L&L VENT-SURE DOWNDRAFT KILN VENT INSTRUCTIONS

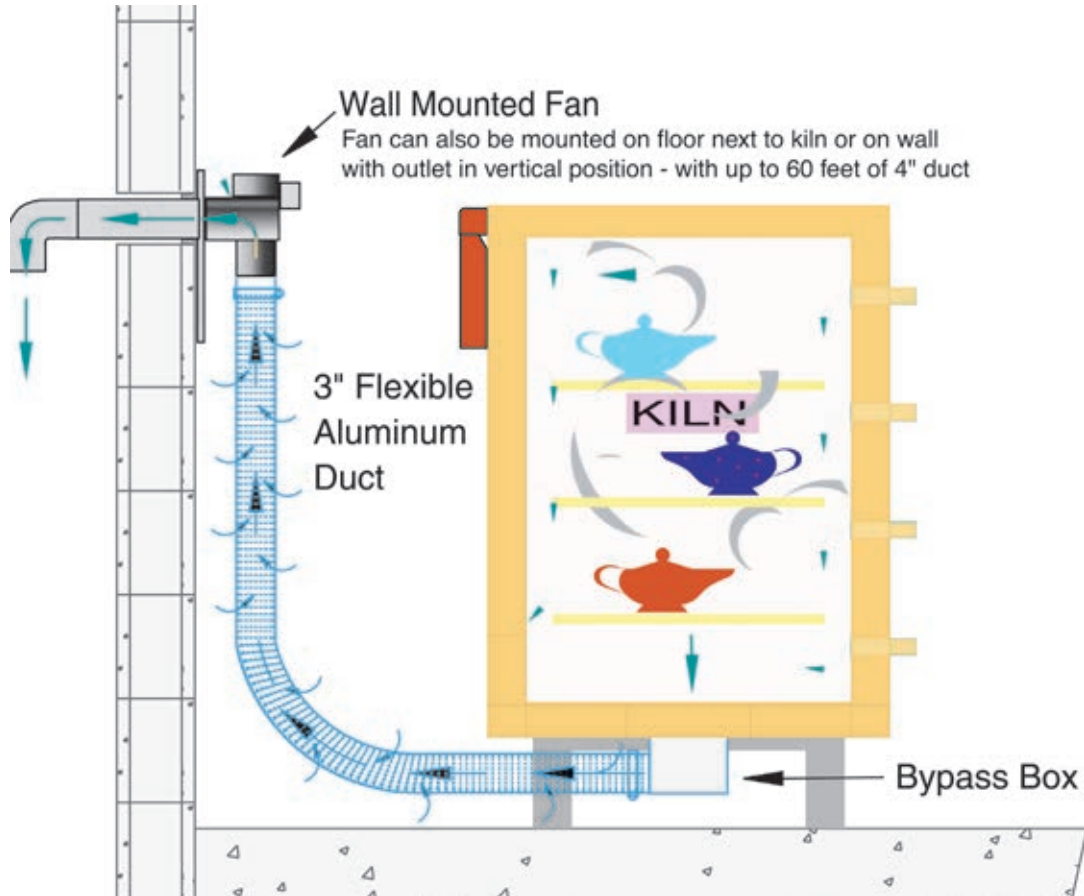

TABLE OF CONTENTS

TABLE OF CONTENTS	1
READ THE INSTRUCTIONS	1
USEFUL WEB LINKS	1
CHECKING SHIPMENT	2
WHAT IS INCLUDED WITH VENT	2
IMPORTANT CAUTIONS	2
INSTALLATION TIP BEFORE STARTING	2
INTRODUCTION	3
KILN VENTILATION CAUTIONS	3
INSTALLATION	3
ROOM AIR REPLACEMENT	4
DRILL CHART	5
OPERATION	5
ADJUSTING THE BYPASS SYSTEM	5
VENTING CODES	6
REGULAR MAINTENANCE	6
INSTALLATION OF MULTIPLE VENTS	6
OPTIONAL VENT CONTROL	7
FREQUENTLY ASKED QUESTIONS	7
FEATURES AND SPECIFICATIONS	9
MOTOR SPECIFICATIONS	10
PARTS	10

READ THE INSTRUCTIONS

You are now the proud owner of an L&L “VENT-SURE” kiln ventilation system, engineered to give you the utmost in performance and results. This is an expensive and potentially hazardous appliance (if not used with proper caution). PLEASE TAKE THE TIME TO READ THESE INSTRUCTIONS. There is important information that you need to understand in order to operate your L&L kiln ventilation system safely and effectively.

USEFUL WEB LINKS

See this video on how to install a vent:
hotkilns.com/install-vent-sure

See this video on how to drill holes for a vent:
hotkilns.com/drilling-holes-vent-sure-vent-system

L&L VENT-SURE DOWNDRAFT KILN VENT INSTRUCTIONS

CHECKING SHIPMENT

Your ventilation system was carefully packed and inspected prior to shipment to make sure that all parts were in perfect condition.

When carrier makes delivery, you should immediately unpack your ventilation system and accessories to determine whether or not any damage has occurred in transit.

If damage has occurred, retain all of the packaging material and notify L&L at once. Retain all papers to ensure that a proper claim can be filed.

WHAT IS INCLUDED WITH VENT

One (1) wall-mounted blower mounted on a bracket with vent pipe to go through outside wall and a Motor Inlet Duct. An 8 foot power cord with an attached On/Off switch plugs into a 120 volt standard receptacle. (Note: 220-240 volt models will have a different cord).

One (1) Bypass Collection Box to be mounted to the kiln stand, with mounting hardware.

One (1) length of flexible aluminum ducting (expands to 15 feet) with two (2) hose clamps.

One (1) 4" diameter 90 degree elbow (for outside the building).

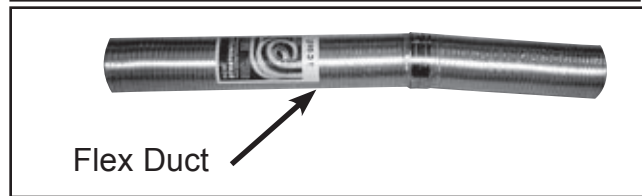
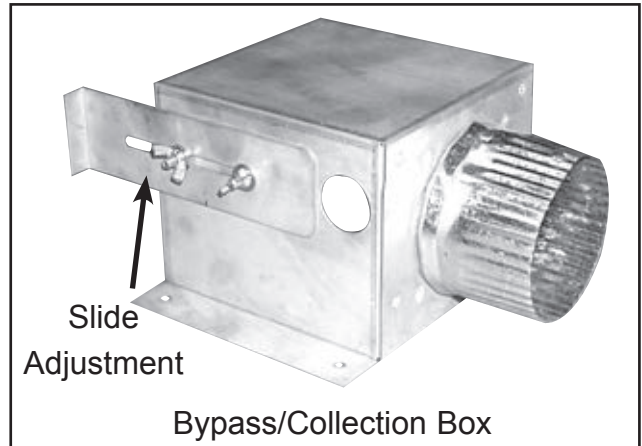
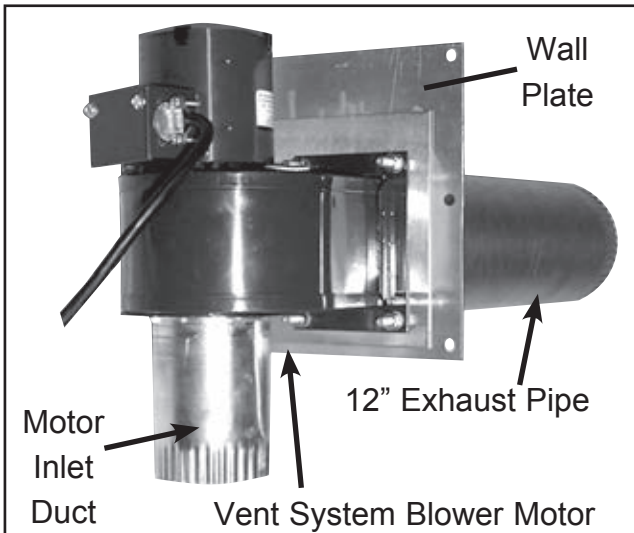

IMPORTANT CAUTIONS

Check duct occasionally to see if there is wax or other residual build up. Wax could condense in the duct, which is a potential fire hazard. This is especially important if you are using a wax resist.

Be sure that the exhaust of the vent is not being brought back into your building. Keep exit of vent at least four feet away from any open windows or doors.

We recommend the use of a carbon monoxide monitor in your kiln room. These are available from good hardware stores for about \$50 (This is another good way to be sure you are getting proper venting).

Disconnect power cord from power source when doing any maintenance on the fan motor. Do not put your fingers inside the blower without disconnecting power. Blower may start unexpectedly because of automatic thermal shut off switch built into the motor.

DO NOT place anything in the blower/motor while powered. Serious injury and/or damage to the motor could result.

INSTALLATION TIP BEFORE STARTING

NOTE: Attach the Bypass Box to the stand and the aluminum duct to the Bypass Box before installing the kiln on the stand because it can be hard to do this when the kiln is on top of the stand.

L&L VENT-SURE DOWNDRAFT KILN VENT INSTRUCTIONS

INTRODUCTION

WHAT DOES THE VENT DO?

The Vent-Sure Kiln Ventilation System is designed to pull air contaminated with carbon monoxide and other fumes including those of volatile metals, decals, sulfur oxide, and others in a down draft fashion out of the kiln and then vent it outside or to a central vent system.

KILN VENTILATION CAUTIONS

VENTILATION IS ESSENTIAL

1. Kilns generate harmful fumes when firing ceramics including: carbon monoxide, sulfur oxides, hydrogen fluoride and metal vapors (all of which can be toxic).
2. Install kiln in a well-ventilated area and never operate in an enclosed space unless you have good airflow.
3. Severe corrosion can be caused by kiln fumes, salt air, or other environmental conditions.

AMBIENT HEAT AND VENTILATION

1. The kiln should operate in an environment that is between -18°C (0°F) and 38°C (100°F).
2. Kiln vents do not take care of ambient ventilation of the kiln room to remove the heat of the kiln.
3. See the following web page for guidance on how to calculate ventilation requirements for a kiln room: hotkilns.com/calculate-kiln-room-ventilation

INSTALLATION

IMPORTANT CAUTION

MAKE CERTAIN KILN POWER IS OFF BEFORE PROCEEDING WITH INSTALLATION.

Step 1. Turn Off Kiln Power

This is critical for safety reasons.

Step 2. Drill Holes (if needed)

Before mounting the Bypass Box, you should drill the vent holes. (Note: if you bought the vent system with a new kiln, it should be pre-drilled) The easiest way to drill the vent holes is to place the stand upside-down on the kiln bottom, center it, and then drill your holes within the large aperture. Otherwise you can measure out the center of your kiln slab and draw a circle in the middle with a radius of 1.5" Then drill your vent holes within that circle.

Step 3. Install Bypass Collection Box

With the vent holes taken care of, you can install the Bypass Collection Box. Just simply use the studs on the bottom of the stand and secure with the provided hardware.

IMPORTANT: Remember to have the outlet pointed towards your fume exhaust location.

The Bypass Collection Box is mounted to the bottom of the stand with provided hardware.

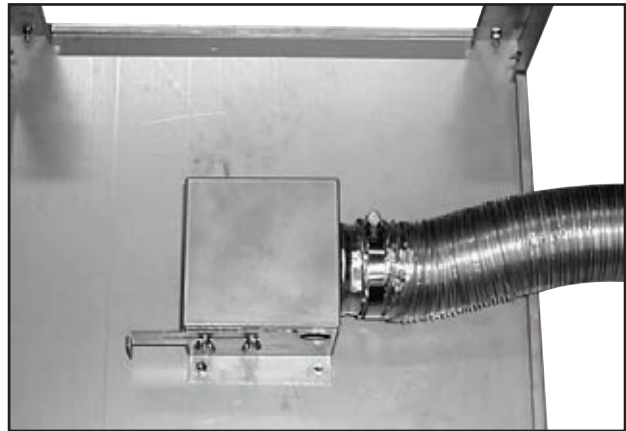

Step 4. Install Blower System

Install blower system by penetrating outside wall or setting into a window with appropriate support. Attach the provided 90 degree elbow to point down on the outside of the building (this is to prevent rain water from getting into the duct). (Note: this procedure will change if you use the Multi-Mount bracket). Mount securely because motor may vibrate over time especially if it builds up any dust in the blower.

The motor assembly comes pre-mounted onto the Wall mount bracket:

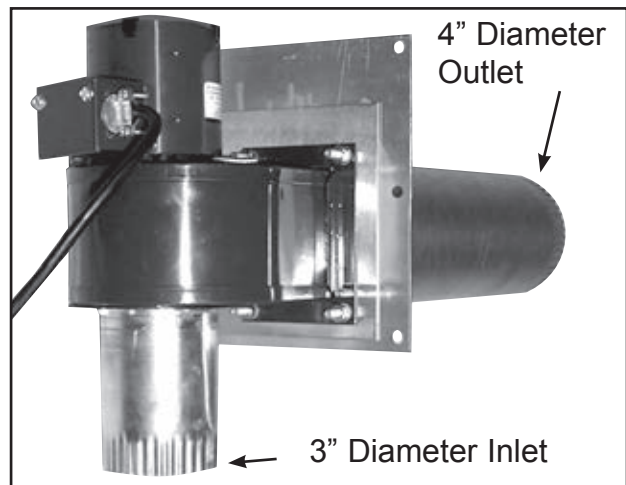

L&L VENT-SURE DOWNDRAFT KILN VENT INSTRUCTIONS

CAUTION: Make sure that the vent outlet is at least four feet from any open windows or doors. This is to make sure fumes do not get back into your building. Also the fumes can be hazardous to plants within a few feet.

Vent-Sure Installation Diagram

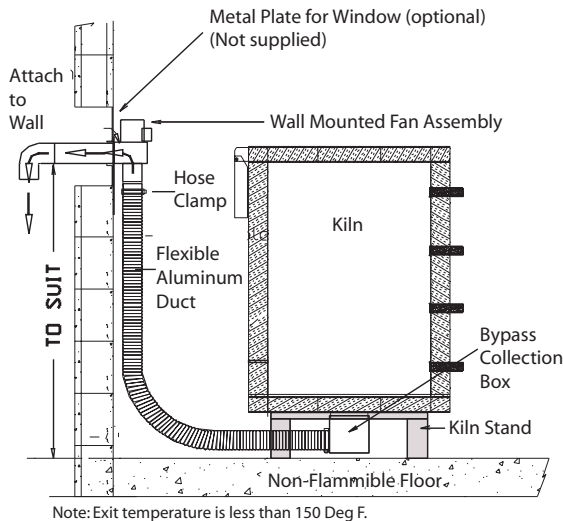

A CAUTION ABOUT MOUNTING VERTICALLY

If the discharge duct of the vent is mounted pointing up (as shown on the photograph to the left), water that condenses in the duct may drop down and rust the motor. We recommend having a water trap in the bottom of a vertical duct run to drain off the water before it runs into the motor. This is not a problem when the vent has been mounted horizontally. The Multi-Mount bracket will allow you to mount the motor horizontally as well. You can then use 90 degree bends or flexible duct to go vertically. Just remember that there is water in the exhaust that will condense somewhere as it cools after it discharges from the vent motor.

A special Multi-Mount bracket is available from L&L which will allow you to mount the vent on the floor or wall with the outlet of the vent pointing up. This is useful when you want to use an existing penetration in a wall that won't support the vent (like a window) or when you want to have the vent go out of a roof or into a central vent system.

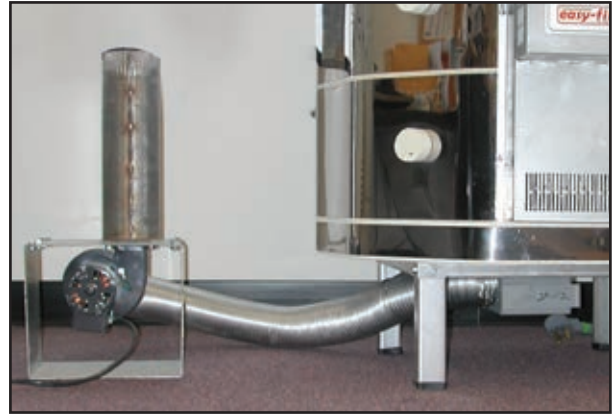

Step 6. Connect Flexible Duct

Attach blower system to bypass/collection box by stretching the flexible aluminum duct carefully (it can extend up to 15 feet) and securing to both the blower housing and the bypass/collection box with the provided hose clamps. **NOTE: You may want to firmly attach this to the Bypass Collection Box before installing the kiln on the stand because it can be hard to maneuver under the kiln.**

Step 7. Plug In Vent

Plug in the switched cord to a standard 120 volt receptacle. **If need be you can safely use a grounded extension cord because of the small amperage required.** Be sure to secure cord away from heat of kiln. Note: On 220-240 volt models this may vary.

ROOM AIR REPLACEMENT

ROOM AIR REPLACEMENT:

The Vent-Sure system moves up to 146 cubic feet of air per minute. We suggest opening a window slightly, or bringing another fresh air source into the room, to replace this room air.

L&L VENT-SURE DOWNDRAFT KILN VENT INSTRUCTIONS

DRILL CHART

MODEL HOLE	CUBIC FT	NO OF HOLES DIA	
FUEGO	1.5	1	1/4"
e23S	4.7	2	1/4"
e23T, SM23T, EQ23T	7.0	2	1/4"
e28S	6.9	2	1/4"
e28T, SM28T, EQ2827	10.3	3	1/4"
JD18, E18S, LB18	2.6	1	1/4"
JD18X, E18T	3.9	1	1/4"
JF23	4.7	2	1/4"
J230	7.0	2	1/4"
J236, EQ2836	9.4	3	1/4"
J245	11.75	3	1/4"
J2918	6.9	2	1/4"
J2927	10.3	3	1/4"
J2936	13.8	4	1/4"
J2945	17.2	5	1/4"
X1818	3.4	1	1/4"
X1827	5.1	2	1/4"
XB2318	5.0	2	1/4"
X2327	8.1	2	1/4"
X2336	10.8	3	1/4"
X2345	13.5	4	1/4"
XB2818	7.8	2	1/4"
X2827	11.7	3	1/4"
X2836	15.6	4	1/4"
X2845	19.5	3	5/16"
XB3218	10.0	3	1/4"
X3227	15.0	4	1/4"
X3236	20.0	3	5/16"
X3245	25.0	4	5/16"
TB2318	9.7	3	1/4"
T2327	14.6	4	1/4"
T2336	19.4	3	5/16"
T2345	24.3	4	5/16"
TB3418	13.8	4	1/4"
T3427	20.7	3	5/16"
T3436	27.6	5	5/16"
T3445	34.5	6	5/16"
EL2424	8.0	2	1/4"
EL2427	9.0	3	1/4"
EL2436	12.0	3	1/4"
EL2448	16.0	4	1/4"
EL2848	20.0	4	5/16"
EL3048	25.0	5	5/16"

OPERATION

1. Plug blower cord into 120 Volt receptacle. (Note: 220-240 volt models may be different).
2. Close all kiln apertures such as peepholes unless you very specifically want more air vented.
3. Turn on Vent with the in-line switch on the power cord.
4. Close the lid and fire. For heavy loads with lots of fumes you may want to avoid firing faster than 150°F per hour to prevent the generation of more fumes than the system can eliminate.
5. Use the flow control on the Bypass Box to modify the flow of exhaust - a larger flow control opening reduces the flow of exhaust fumes from the kiln, and a smaller flow control opening increases the exhaust.

ADJUSTING THE BYPASS SYSTEM

The sliding adjuster allows you to fine adjust the amount of venting that is done to your kiln. It is easy to adjust but hard to know just how to adjust it. The problem is that there are many factors that contribute to the amount of "pull" required. For instance, the amount of fumes that are being given off by your specific work is one factor. Some clays have a lot of carbon in them; others do not. Depending on the size of the load, and the ingredients in the clay/glaze, there will be more or less fumes generated. Another factor is the "static pressure" in your vent ducts. If you have a lot of curves, 90 degree bends, or long runs of duct this will increase the static pressure (back pressure) and hence increase the need for more venting force. One suggestion is to start with the valve in the half open position and see what happens.

The Smoke Method:

- 1) With power disconnected from the kiln and with the kiln empty, turn the vent on.
- 2) Start with the bypass valve in the fully closed position. This will give it the maximum suction in the kiln.
- 3) Light a piece of paper on fire or something that will create smoke. Blow it out, and hold it near the cracks around the closed lid.
- 4) If the smoke is being pulled into the kiln around these door cracks, open the Bypass (decreasing flow from the kiln) until the smoke stops being pulled in, then back up the valve slightly, so the draw increases just slightly again. Try this when kiln is at about 100°F.
- 5) You can do the same test directly at the bottom hole with the kiln open also to test the differential between the pull

L&L VENT-SURE DOWNDRAFT KILN VENT INSTRUCTIONS

at the actual suction hole from the kiln and the pull around the lid.

For Gross Adjustment:

Remember that the sliding adjuster is for fine adjustment. Drilling or plugging the holes in the floor (and possibly adding or plugging holes in the top) is how you would dramatically change the amount of air vented.

VENTING CODES

OSHA has set standards for carbon monoxide exposure of 35 ppm (parts per million) for long-term exposure and 200 PPM for short-term exposure. Independent testing has shown that fumes near the kiln can exceed 200 PPM near the kiln during the firing of greenware. This can cause headaches, fatigue, sore throats and nausea. When properly installed and operated, a downdraft vent removes all harmful fumes and provides a safer working environment.

Most states and localities have set venting requirements for firing kilns in public places. Your local and state health board should have this information.

The Uniform Mechanical Code says that you must vent ceramic kilns. It says that you can use a canopy-type hood (and gives specific requirements for such use) or that "listed exhaust blowers may be used when marked as being suitable for the kiln and installed in accordance with manufacturer's instructions."

Our Vent-Sure vent is listed to UL499 standards by MET for L&L Kilns and is appropriate to meet this ventilation requirement. L&L takes no responsibility for improperly installed vents or kilns nor do we take responsibility for the use of other vents with our kilns.

REGULAR MAINTENANCE

Occasionally check for leaks in the aluminum duct. Replace if necessary. Check for corrosion especially if you are using clay with a high content of sulfur, phosphorus or fluorine. Check for wax or carbon build up if you are using a wax resist process or a high carbon content clay.

We recommend unmounting the fan and blowing out the squirrel cage with compressed air every two years or so especially if you are in a very dusty or if you have it mounted on the floor where it is more likely to pick up dust.

If the discharge duct of the vent is mounted pointing up you may get water that condenses in the duct drop down and rust out the motor. Taking it apart and spraying with WD-40 can restore the motor in some cases. We recommend

having a water trap in the bottom of a long vertical duct run to drain off the water before it runs into the motor. This is not a problem when the vent has been mounted horizontally.

INSTALLATION OF MULTIPLE VENTS

For more information see:
hotkilns.com/vent-doubler-system

VENT DOUBLER SYSTEM

This shows a photograph of the Vent Doubler System:



The Vent Doubler system includes an extra Bypass Collection Box, an extra Flexible Aluminum Duct and a "T" Connector with dampers. You can vent two 10 cubic kilns with one Vent-Sure plus this Vent Doubler System.

CENTRAL VENT SYSTEMS

Multiple Vent-Sure systems may be installed individually, or each system may be connected to a central duct. The following information is provided to help the installer make decisions concerning the size and length of the central duct.

CENTRAL DUCT SIZING

QTY OF SYSTEMS SIZE OF CENTRAL DUCT

QTY OF SYSTEMS	SIZE OF CENTRAL DUCT
1	4"
2	6"
3	8"
4	8"
5	10"
6	10"

EXTENDING DUCT LENGTH

The duct may be 60 feet in length, and include up to four 90° bends, without a significant drop in static air flow or a reduction in kiln air pull. You may use any galvanized, stainless or aluminum duct. The outlet duct size (after the motor) is 4" diameter. The inlet duct (before the motor) is 3" diameter.

L&L VENT-SURE DOWNDRAFT KILN VENT INSTRUCTIONS

OPTIONAL VENT CONTROL

For more information see:
hotkilns.com/vent-control

The Vent Control allows you to automatically control the operation of the Vent-Sure kiln vent with one of the outputs from the DynaTrol (or Genesis).



Construction

The Vent Control consists of a relay that is controlled from output #4 on the DynaTrol (or Genesis).

There is a female 120 volt receptacle to plug the vent into and a cord to plug into a 120 volt wall outlet.

There is a 6 foot wire that connects the control box to the kiln control panel. A grommet is included for non-factory installation.

Where It Can Be Used

It is only available for kilns with DynaTrols and Genesis controls.

It may not be used with kilns with powered bottoms (because the same output on the control is used)

Operation

NOTE: These options are set in the "Hidden Menu" of the DynaTrol.

OPTION A (OP A)

Used to control a vent. Output 4 can be programmed to be on or off during each segment of a Vary-Fire program. During an Easy-Fire program, output 4 comes on at the beginning of the firing and turns off after the kiln has cooled to 150F.

OPTION B (OP B)

Used to control a vent. Output 4 can be programmed to be on or off during each segment of a Vary-Fire program. Output 4 comes on at the beginning of an Easy-Fire program, off at 1450°F, back on after the firing is complete and the kiln has cooled to 1000°F and finally off again when the temperature is below 150°F.

OPTION C (OP C)

Used to control a vent, an alarm, or other atmospheric control. Output 4 can be programmed to be on or off during each segment of a Vary-Fire program. Output 4 is off during Easy-Fire programs.

FREQUENTLY ASKED QUESTIONS

How do I know if the system is working?

See our comments under "Adjusting the Bypass Valve"

How hot does the duct get during the firing?

Not very, for two reasons. One is that the Vent-Sure does not draw out much heat from the kiln. The hotter the kiln gets, the less hot air that is extracted by the vent motor. The other is that the bypass box combines fresh cool air with the hot air from the kiln before passing through the ductwork.

How long can the duct be and how many bends can it have?

Up to 60 feet of ducting containing four 90 degree bends may be safely used with no drop in static air flow at the duct exhaust point or a reduction in draw at the kiln. The ducting can be run either horizontally or vertically. (The Vent-Sure should handle more static pressure than the Orton vent because of the stronger motor. This translates into longer lengths of pipe and more 90 degree bends. If you have a choice run two 45 deg bends rather than one 90 degree bend or use flexible duct which has a gentler bend).

Can I vent through a ceiling and/or roof?

Yes. You will need the multi-mounting bracket (M-V-MULT/00), so that you can position the motor output vertically. Additionally, you need to make sure that you install a water trap. At the bottom of the longest vertical run, install a u-shaped bend to catch any condensation that forms before it enters the motor. Of course if you are going through a roof, you will also need a rain cap and screen.

You do not normally need double wall ducting when going through the roof since the pipe or duct does not reach high temperature. It is always advisable to check your local building codes for their requirements.

L&L VENT-SURE DOWNDRAFT KILN VENT INSTRUCTIONS

How do I determine the size, number, and location of holes in the top and bottom of the kiln?

As a general rule, you should have one 1/4 inch hole for every 4 cubic feet of kiln volume. The holes are normally placed within a 4 inch circle in the center of the kiln floor. Please see our hole chart on page 7. L&L does not normally recommend drilling holes in the top except for certain instances where airflow needs to be increased such as for glazes which need an oxygen rich environment.

Will the fumes coming through the vent damage my plants, the neighborhood pets or disturb the local environment?

For the most part, the fumes have been diluted enough already when they are exhausted, however that depends on how you have your bypass box setup. We do not recommend placing the outlet of the vent below an open window and we have heard of plants near the vent outlet being affected by the vent fumes so keep this in mind when locating vent outlet. Once the fumes are exhausted, they will quickly be diluted by the outside air, so it is only the immediate area around the vent that you need be concerned about.

Will using the vent cause my firing to take longer?

Generally only a little bit longer. The vent system removes only a small amount of heat from the kiln due to the physics of how thin air gets at very high temperatures. (L&L NOTE: We have seen vents overpower smaller kilns - so it is important to adjust the amount of venting in some cases. On the other hand an example of an e23T 7 cubic foot kiln firing an 85 pound load on Fast Glaze program to cone 8 took 7 hours and 4 minutes with a vent on and 6 hours and 24 minutes without a vent. The vent was on the whole time).

What does it cost to operate the vent system?

The vent system should likely cost less than 1 cent/hour to operate (electricity costs). Downdraft vents are still vastly more efficient than hoods which remove tons of air from the kiln room while the Vent-Sure only removes a small amount of air from the kiln. (It does cost more to run the vent because it does take heat out of the kiln. For example an e23T 7 cubic foot kiln firing an 85 pound load on Fast Glaze program to cone 8 took 70 KW hours with a vent on and 62 KW hours without a vent. At 8 cents per KW hour that would be a cost of \$0.64 more for the firing. The vent was on the whole time).

Will the cold air entering the kiln damage the

product?

No. The amount of air coming in is too small unless you drill holes in the lid, which is not normally recommended. The air coming in is also distributed throughout the kiln evenly.

Will faster cooling crack the ware if I leave the vent on during the cooling Cycle?

No. Most kilns will cool faster with the vent system, but it is achieved at such an even rate and distribution that there would not be any damage to ware. (L&L NOTE: The vent will remove more molecules of air and hence heat as the kiln cools. This is because the density of the air increases the lower in temperature you go. This is one reason why kiln vents are so efficient - they don't remove too much heat when you don't want them too at the higher temperatures).

What should I do if I still smell fumes?

Check all ductwork for leaks and see our comments on "Adjusting the Bypass System".

If using a hood type vent (like the Vent-a-Kiln) do you need a kiln vent (like the Vent-Sure) also?

You need to vent fumes from the kiln and the room and heat from the room. You must have ambient ventilation in a small room for heat and to remove fumes that may not be fully removed by the kiln vent. If you have a very large room that can dissipate heat and trace fumes than you may not need ambient ventilation.

The Vent-Sure is designed to remove fumes that are generated in the kiln from the kiln and therefore from the room. The Vent-Sure downdraft kiln vent does not remove enough heat from a small room to be used for ambient ventilation.

If you have a good overhead vent hood you may discharge the output of the Vent-Sure into that hood.

At what temperature should you turn off the Vent-Sure kiln vent?

A customer writes: When firing glazes what is a good temp to turn off the vent so kiln can hit target temp in my case 2190 Deg F. Do glazes off-gas after say 2000 degrees? Is there a general temperature to turn off vent?

Answer: Generally speaking it is best for your kiln to leave the Vent-Sure on for the entire time the kiln is heating up. Mostly this is to get all of the corrosive fumes before they get to your elements, wiring, and other metal parts of the kiln.

You can leave it on for the cooling as well if you need it to cool off more quickly.

L&L VENT-SURE DOWNDRAFT KILN VENT INSTRUCTIONS

Usually a slower cool-down is preferred though, so often the fan is turned off for the cool-down.

High-fire clays and glazes out-gas until the kiln begins to cool. Once the glaze has set, and the clay has vitrified no more gasses escape.

The heat in a red-hot kiln is almost all radiant heat. The hotter the kiln gets, the fewer and fewer air molecules are even present inside. Because of this- it is only helping the heating rate a tiny little bit to turn off the vent before the end of the firing.

How long does a Vent-Sure downdraft vent last?

The Vent-Sure downdraft kiln vent is pulling not only air but moisture and the products of hot moisture and the chemicals that are present in the clay. Some of these products are highly acidic (like sulfuric acid, hydrofluoric acid and others). The exact amount and composition of the effluents of your kiln, and hence in the vent, will vary with how dry your work is and what is in the clay to begin with. The Vent life seems to be totally dependent on these conditions. The more moisture and acids created by the materials in the clay and water then the shorter the vent life. If you have good conditions the vent can last for many years - if not - then you will be replacing various parts over the years.

That said - L&L's experience has been very positive. We have sold thousands of Vent-Sures for over 15 years. We sell very few replacement motors and other parts. The most vulnerable part seems to be the thin aluminum flexible duct that goes from the kiln to the vent motor. This is cheap and you can find replacements locally.

The motors hold up very well in terms of lubrication and vibration. The Vent-Sure is warranted for three years.

FEATURES AND SPECIFICATIONS

ADJUSTABLE AMOUNT OF VENTING

A sliding adjuster on the vent Bypass Collection Box adjusts the amount of venting from the system (see photo on page 3). Vent only what you need to vent - don't waste heat and energy by venting more than you need.

EXTERNAL VENTING

External venting is safer and surer than venting to the inside of your kiln room with a filter.

REMOTE MOUNTING OF MOTOR

The vent blower motor is mounted to a wall plate with a 12" length of exhaust pipe that mounts on the wall (see photo). This keeps the heat of the kiln away from the motor (for longer motor life) and keeps the motor vibration away from the kiln. (With the special "Multi-Mounting Bracket" the vent motor may be mounted on the floor or a wall with the outlet pointing up and then connected to an existing vent system or 4" wall outlet. If you decide to mount it this way see the caution on page 5).

MOUNTS ON ANY L&L KILN

The Vent-Sure vent system can be installed on almost any kiln. It requires only that you drill several small vent holes through the kiln floor (note that if mounting the bypass/collection box to the stand, that four studs are factory installed on the bottom of the stand). Mounting hardware is included.

Note: L&L Vent-Sure vent are not c-MET-us listed for use on any kiln except those made by L&L Kiln Mfg., Inc.

POWERFUL VENT MOTOR

The blower vents up to 146 CFM (cubic feet per minute at 0 static pressure and 110 CFM at 0.500-In. static Pressure). Remember - not all of this air comes from the kiln - some comes from the Bypass Collection Box.

OUTLET TEMPERATURE UNDER 150°F

The outlet temperature of the air is less than 150°F as long as you do not exceed the recommended holes in the kiln.

FLEXIBLE DUCT INCLUDED

15 feet of flexible expandable aluminum 3" diameter duct is included along with necessary hose clamps. Longer lengths or lengths of 3" stove pipe can be used as well.

LOW ELECTRICITY USAGE

The Vent-Sure vent System uses only 0.75 amps at 120 volts.

VENTS UP TO 20 CUBIC FEET OR MORE

The Vent-Sure vent System was designed to be used with all L&L model kilns. We recommend one vent system for kilns up to approximately 20 cubic feet. On larger kilns, depending on how much venting you need, you may need more than one vent system. (This really depends on how much venting you need for your situation). Even our largest 35 cubic feet DaVincis have usually been adequately vented with one Vent-Sure. Note that you can always add another vent if you find you need more venting.

L&L VENT-SURE DOWNDRAFT KILN VENT INSTRUCTIONS

MOTOR SPECIFICATIONS

120 VOLT MOTOR

PSC Blower, Type:Forward Curve, Direct Drive

Wheel Dia. (In.):3-15/16, Wheel Width (In.):2-1/2

CFM @ 0.000-In. SP:146, CFM @ 0.100-In. SP:140, CFM @ 0.200-In. SP:126, CFM @ 0.300-In. SP:124. CFM @ 0.400-In. SP:120, CFM @ 0.500-In. SP:110,

Voltage:115, Hz:50/60, Phase:1, Full Load Amps:0.75, RPM:3100

Bearing Type:Ball, Motor Type:Permanent Split Capacitor, Motor Enclosure:Open, Motor Insulation:Class B, Thermal Protection:Auto

Lead Length (In.):13, Conduit Box:Yes,

Ambient Temp. (Deg. F):104, Max. Inlet Temp. (Deg. F):104

Inlet Dia. (In.):3-1/8, Outlet Height (In.):2-3/16, Outlet Width (In.):3-1/4, Overall Height (In.):5-3/4, Overall Width (In.):6-5/16, Overall Depth (In.):5-3/8, Mounting:All Position, Housing Finish:Gray Enamel, Housing Material:Rolled Steel

Agency Compliance:UL Recognized US and Canada (E47479)

220-240 VOLT MOTOR

Item-PSC Blower, Type-Forward Curve, Direct Drive

Wheel Dia. (In.):3-3/4, Wheel Width (In.):1-7/8

CFM @ 0.000-In. SP:133, CFM @ 0.100-In. SP:128, CFM @ 0.200-In. SP:126, CFM @ 0.300-In. SP:119, CFM @ 0.400-In. SP:112, CFM @ 0.500-In. SP:105,

Voltage:230, Hz:50/60, Phase:1

Full Load Amps:0.33, RPM:2880

Bearing Type:Ball, Motor Type:Permanent Split Capacitor, Motor Enclosure:Open, Motor Insulation:Class B, Thermal Protection:Auto, Lead Length (In.):13, Conduit Box:Yes, Ambient Temp. (Deg. F):104, Max. Inlet Temp. (Deg. F):104

Inlet Dia. (In.):3-1/4, Outlet Height (In.):2-1/2, Outlet Width (In.):2-9/16, Overall Height (In.):6-9/16, Overall Width (In.):5-5/8, Overall Depth (In.):6-9/16

Mounting:All Position, Housing Finish:Gray Enamel, Housing Material:Rolled Steel

The Vent-Sure vent is c-MET-us listed in both the US and Canada for use with L&L listed kilns. UL 499, CSA C22.2, No. 122, CSA C22. Listing No E112742.

PARTS

Prices of all parts are listed at:
hotkilns.com/parts

Complete Vent-Sure Kiln Vent System

M-V-VENT/00 (see web)

VENT-SURE Vent. 120 Volt. Complete System as described above and on our separate Vent-Sure brochure. This includes the motor, an 8 foot cord with a rocker type On/Off switch mounted in line in the cord, the inlet duct attached to the motor, the wall mounting bracket, a 90 deg elbow for mounting on the end of the outlet pipe (to keep rain water out), the Bypass Collection Box for attaching to the kiln stand or kiln side along with mounting hardware for mounting to an L&L kiln stand and one section of 15 foot flexible aluminum duct with hose clamps.

M-V-VENT/41 (see web)

VENT-SURE Vent. 220-240 Volt. Typically used in non-US installations.

You can also purchase individual parts to suit your own configuration or as replacements:

Below shows the vent system blower assembly with the motor, cord and switch set, 3" inlet duct to hold the flexible duct, 12" duct to go through a wall and 90 Degree elbow.

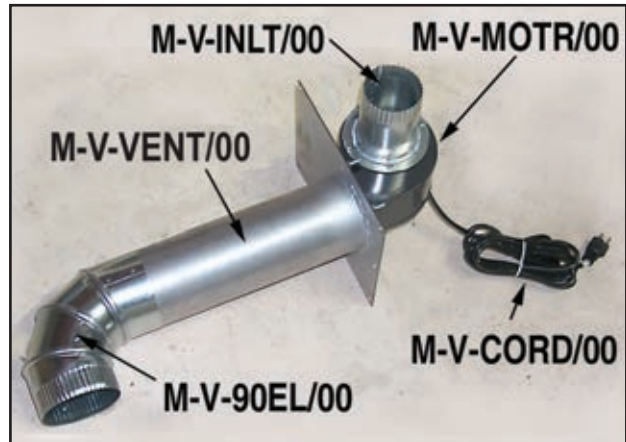

M-V-FANK/00.....(see web)

Complete blower assembly. Pictured above ^

M-V-FAN0/00 (see web)

Fan/Blower Motor for Vent-Sure. 120 Volts. This is just the motor with no attached brackets or inlets. Cord is not included.

M-V-FAN0/41 (see web)

Fan/Blower Motor for Vent-Sure. 220-240 Volts. This is just the motor with no attached brackets or inlets. Cord is not included.

M-V-BRKT/00..... (see web)

Steel plate onto which the motor mounts. Includes 4" x 12" outlet pipe and output mounting plate.

M-V-INLT/00..... (see web)

Motor Inlet Duct. This is the piece of duct that attaches to the inlet of the motor. The expandable aluminum duct fits onto this.

L&L VENT-SURE DOWNDRAFT KILN VENT INSTRUCTIONS

M-V-OUTT/00..... (see web)
 Motor Outlet Duct. This is the piece of duct that attaches to the outlet of the motor.

M-V-90EL/00..... (see web)
 90 Deg 4" elbow. Used for attaching to motor mount duct to the outside to prevent water from getting into duct.

M-V-CORD/00..... (see web)
 Power Cord for Vent-Sure. Includes a cord mounted on/off switch. (Call factory for non-USA cords)

Power Cord with On/Off switch:



M-V-DUCT/00..... (see web)
 Flexible Vent Duct 2-1/2 to 15 Feet Expandable, Flexible Aluminum 3" duct with two hose clamps.

Flexible Aluminum Duct shown with hose clamps:



M-V-BBOX/00..... (see web)
 Bypass Collection Box. Includes hardware for mounting and slide control. Note: This has the proper mounting hole configuration to be mounted to any L&L kiln stand. It can also be mounted to the side of other kilns (typically on the bottom section).

Bypass Collection Box:

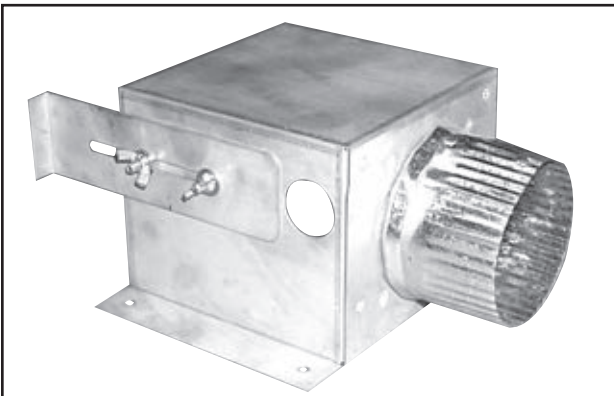

M-V-MULT/00..... (see web)
 Multi-Mounting Bracket. Comes with six (6) sets of 1/4-20 bolts, nuts and lock washers for mounting this to the "Wall mount bracket" (M-V-VENT/BK).

This special "Multi-Mounting Bracket" will allow you to mount the vent on the floor or wall with the outlet of the vent pointing up. There are mounting holes on the bottom (for floor mounting) and on the side as well (for wall mounting):



M-V-VENT/DB..... (see web)
 Vent Doubler System for Vent-Sure. Includes a "T" duct with dampers, an extra Bypass Collection Box, Extra Flexible Duct. (Consider buying the Multi-Mounting Bracket which is not included but sometimes useful for this installation as shown in the photograph).

Vent Doubler System:

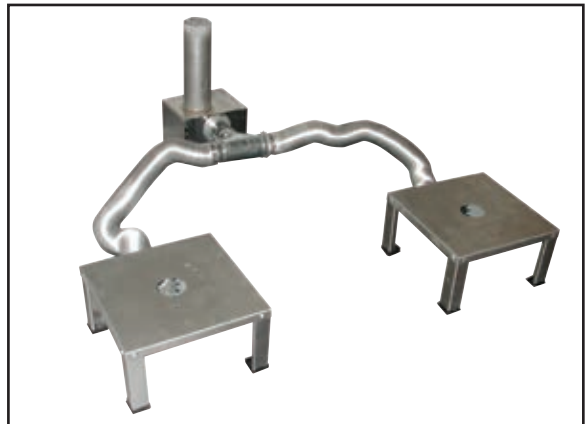

M-V-TDUC/00..... (see web)
 "T" DUCT to attach two aluminum flexible ducts to. Includes dampers on the two inlets. The outlet fits onto the Motor Inlet Duct of the Vent-Sure and the Flexible Vent Duct(s) fit onto the inlets of this "T" Duct. (NOTE: The Multi-Mounting Bracket is shown in the photograph but NOT included in the system).

Special "T" duct for doubler system:

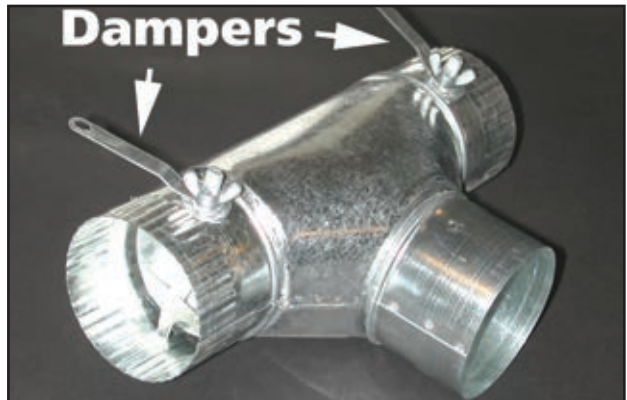

LIBERTY-BELLE INSTRUCTION MANUAL

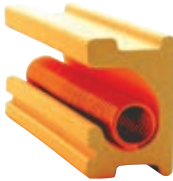

L&L Kiln's patented
hard ceramic
element holders
protect your kiln.

OPERATION OF L&L KILNS WITH A ONE-TOUCH™ (Deg F)

Basic instructions are printed directly on the faceplate for easy reference.

Press the Enter button to start the program you have selected to fire.

Press and hold down Delay to enter a countdown time to delay the start of your program.

Press and hold down Review to see what program you are running.



The display area provides lots of information such as temperatures, program prompts, etc.

Choose one of either the Bisque or Glaze programs. They are preprogrammed for immediate no hassle use. Press for 5 seconds to bring up easy options like cone, heating & cooling rate and hold time

The Custom option allows more experienced users to create and save four of your own ramp/hold programs.

22. TABLE OF CONTENTS

1. WATCH THE VIDEO FIRST!	2
2. HOW YOUR KILN WORKS	2
3. TYPEFACE CONVENTIONS	2
4. NOTE ABOUT CONES	2
5. CONE 6 & CONE 10 VERSIONS	2
6. DEGREES CENTIGRADE	2
7. FIRST FIRING	2
7.1 FIRST FIRING IN ONE FIRING (16 HOURS)	2
7.1.1 START.	
7.1.2 CHOOSE CUSTOM PROGRAMMING	
7.1.3 PICK CUSTOM PROGRAM #1	
7.1.4 MOVE THROUGH THE PROGRAM AND START	
7.1.5 REVIEW PROGRAM	
7.1.6 COMPLETE	
7.2 FIRST FIRING IN TWO FIRINGS (2 x 9 HOURS)	3
8. TURNING ON THE KILN	3
9. THREE MODES OF OPERATION	3
9.1 SIMPLE (Bisque or Glaze)	3
9.2 SIMPLE WITH CHANGES (Bisque or Glaze)	4
9.2.1 TO CHANGE A SIMPLE OPTION	
9.2.2 EXAMPLE: CHANGE CONE OF BISQUE FIRE	
9.2.3 EXAMPLE: CHANGE SPEED OF BISQUE FIRE	
9.3 CUSTOM (Ramps and Holds):	5
10. RESETTNG FACTORY DEFAULTS	5
11. HOW TO CANCEL A FIRING	5
12. STANDARD (SIMPLE) PROGRAMS	5
12.1 STANDARD BISQUE PROGRAMS	6
12.1.1 Slow Bisque (Default Bisque Program)	
12.1.2 Medium Speed Bisque	
12.1.3 Fast Speed Bisque	
12.2 STANDARD GLAZE PROGRAMS	6
12.2.1 Slow Glaze	
12.2.2 Medium Glaze (Default Glaze Program)	
12.2.3 Fast Glaze	
12.3 SIMPLE COOL DOWN SPEEDS	7
13. CUSTOM RAMP/HOLD PROGRAMMING	7
13.1 REUSE A PREVIOUS PROGRAM	7
13.2 CHANGING A PROGRAM (STEP BY STEP)	7
13.2.1 START	
13.2.2 CHOOSE CUSTOM PROGRAMMING	
13.2.3 PICK A PROGRAM	
13.2.4 SPECIFY NUMBER OF SEGMENTS	
13.2.5 ENTER RAMP RATE	
13.2.6 ENTER HOLD TEMPERATURE	
13.2.7 ENTER HOLD TIME	
13.2.8 REPEAT STEPS FOR EACH SEGMENT	
13.2.9 SET A DELAY (OPTIONAL - CAN BE SKIPPED)	
13.2.10 START FIRING!	
13.2.11 REVIEW PROGRAM	
13.2.12 COMPLETE THE FIRING	
14. KILN OPERATION DURING A CUSTOM FIRING PROGRAM	9
14.1 DESCRIPTION	9
14.2 OPTIONS DURING FIRING	9
14.2.1 DISPLAYING THE CURRENT SET-POINT AND ACCESSING THE FOLLOWING OPTIONS	
14.2.2 SKIP STEP	
14.2.3 ADD TIME TO HOLD PERIOD	
14.2.4 ADD TEMPERATURE TO HOLD PERIOD	
15. CUSTOM PROGRAMS	10
15.1 CUSTOM PROGRAM 1	10
15.2 CUSTOM PROGRAM 2	10
15.3 CUSTOM PROGRAM 3	10
15.4 CUSTOM PROGRAM 4	10
16. OPTIONS	10
16.1 ACCESSING OPTIONS	10
16.2 OPTIONS	10
16.2.1 SOUND: BEEPING ON OR OFF AT END OF PROGRAM	
16.2.2 MAXIMUM TEMPERATURE	
16.2.3 TEMPERATURE INDICATION	
16.2.4 THERMOCOUPLE OFFSET	
17. MESSAGES & DISPLAYS	11
18. ERROR CODES	12
19. SOFTWARE VERSION	12
20. CENTIGRADE INSTRUCTIONS	12
21. SPECIFICATIONS	12

OPERATION OF L&L KILNS WITH A ONE-TOUCH™ (Deg F)

1. WATCH THE VIDEO FIRST!

We highly recommend watching the video before you read this instruction manual for quicker understanding of how this great control works. *Go to hotkilns.com/one-touch-video*

2. HOW YOUR KILN WORKS

The One-Touch™ Intuitive Kiln Control was designed for busy school teachers, contemporary studios, and hobbyists. No programming is necessary - simple adjustments are easy, yet sophisticated programming is also easy.

The One-Touch automatic program control uses one thermocouple to measure the temperature of the kiln.

The control automatically adjusts power by turning power contactors on and off to control the heat up of the kiln according to the program you are firing.

The preprogrammed Bisque and Glaze programs are set to fire to the most universally accepted versions of these programs, which makes firing basic ceramics easy. These are a slow bisque to Cone 04 and a Medium Glaze to Cone 06.

There are three modes of operation:

1. **Simple** (just the basic Bisque and Glaze programs as mentioned above)
2. **Simple with Changes** (you can adjust a few basic parameters like heat up speed, cool down speed, candling time at a low temperature, and the cone to fire to)
3. **Custom** where you program all ramps and holds yourself.

3. TYPEFACE CONVENTIONS

1. Typeface font: **CUSTOM** indicates a Button on the control.
2. Typeface font: **CUS1** indicates what you see in the display.
3. Typeface font: **URL** indicates a web link.

4. NOTE ABOUT CONES

Cones measure “heat work” rather than just final set point temperature. It is like baking a turkey. You can bake it slow at a low temperature or bake it fast at a high temperature.

The One-Touch™ control adjusts the final set point temperature based on the **actual** final ramp rate of the kiln (in the last segment of any program). It does this to achieve a particular result (which is the correct bending of the cone) rather than a particular final temperature.

For a full explanation of cones go to hotkilns.com/what-cone-numbers-mean

If you want to see the Orton Cone Chart go to hotkilns.com/orton-cone-chart.

Note: you can adjust how the kiln fires by adjusting the thermocouple offset. For instance, if your kiln is firing cool (according to a witness cone placed in the kiln) then you can add positive Offset. If it is firing hot then you can reduce the offset or put in a negative offset. See the **OPTIONS** section on page 11 for instructions on how to do this.

5. CONE 6 & CONE 10 VERSIONS

There are two versions of the control: Cone 6 and Cone 10. The Cone 6 versions are used on the School-Master kilns to limit the maximum temperature of the kiln. Liberty-Belle, Doll, Fuego and Robin kilns use the Cone 10 version. There are only minor differences as noted in these instructions. The main issue is the maximum temperature that the control will let the kiln go to.

6. DEGREES CENTIGRADE

Your control comes set up to display Degrees Centigrade. This can easily be changed to display in Degrees Fahrenheit (see the **OPTIONS** section).

OPERATION OF L&L KILNS WITH A ONE-TOUCH™ (Deg F)

7. FIRST FIRING

Three of the **CUSTOM** programs have been programmed by the factory to simplify the first firing process.

Once this process has been completed they may be reprogrammed at will.

7.1 FIRST FIRING IN ONE FIRING (16 HOURS)

7.1.1 START.

1. Start with the display reading **IdLE** and flashing a temperature or **StOP** and temperature.

7.1.2 CHOOSE CUSTOM PROGRAMMING

1. Press **CUSTOM**
2. See **CUS1**
3. Press **ENTER**

7.1.3 PICK CUSTOM PROGRAM #1

1. You will see **CUS1**, **CUS2**, **CUS3** or **CUS4**. These are the four custom programs.
2. Scroll to **CUS1** with the **UP** and **DOWN** button.
3. Select **CUS1** by pressing the **ENTER** button.

7.1.4 MOVE THROUGH THE PROGRAM AND START

1. Press **ENTER** for each display prompt that you see as the control scrolls through the enter **CUS1** program until you see **FIrE**.
2. Press **ENTER** again when you see **FIrE** and the One-Touch control will start firing the kiln using the **CUS1** program.
3. You will know it is firing because the display just reads the kiln temperature steadily. You will probably also hear the relays clicking on and off.
4. There is a list of Preprogrammed Custom Programs later in this manual which will show you a list of values for **CUS1** you see while pressing **ENTER**.

7.1.5 REVIEW PROGRAM

1. Press the **REVIEW** button to review the program.
2. You can do this when you see the **FIrE** display, **CUS1**, **CUS2**, **CUS3**, **CUS4** or while firing (when you see the kiln temperature).
3. The display will scroll though the name of the program (i.e. **CUS4**), then the number of segments, then all the

ramps, temperatures and holds in sequence.

4. The display changes rapidly so you may have review more than once to see everything.

7.1.6 COMPLETE

1. When the program is complete, you will see **CPLt**.
2. If the Beep option has been turned to “**On**” then the control will beep about 15 times. If the beep option is set for “**OFF**,” then there is no sound. If the beep option is set for “**FULL**,” the control will beep until any button is pressed. See the OPTIONS section in these instructions for how to change this option.

7.2 FIRST FIRING IN TWO FIRINGS (2 x 9 HOURS)

1. Go through the above process but do it in two programs. It works the same as above except that you run the two separate programs at different times.
2. **CUS2** is the first program and that takes about 9 hours.
3. **CUS3** is the second program and that also takes about 9 hours.
4. See the list of Preprogrammed Custom Programs later in this manual for a list of values you see while pressing **ENTER**.

8. TURNING ON THE KILN

1. Make sure your circuit breaker or fused disconnect switch is turned on and the kiln is plugged in.
2. Turn on kiln with the toggle On/Off switch on the control box.
3. You will see a software code flash briefly. Then you will see either **IdLE** or **StOP** alternating with a display of the current kiln temperature.

9. THREE MODES OF OPERATION

9.1 SIMPLE (Bisque or Glaze)

1. Press one of two buttons marked **BISQUE** and **GLAZE**.
2. You will then see either **bISC** or **GLA** depending on which button you pressed.
3. The **bISC** is a slow bisque to Cone 04. The **GLA** is a medium glaze to Cone 06.

OPERATION OF L&L KILNS WITH A ONE-TOUCH™ (Deg F)

4. Press **ENTER** and the display reads **FiRE**.
5. You can add a delay time to the program by pressing the **DOWN** arrow when you see **FiRE** but before you press **ENTER**.
6. After you press the **DELAY** button, you will see **dELA** flashing with a time value, typically **00.00** which represents 00 hours and 00 minutes.
7. After you see this flashing display, you can press the **UP** or **DOWN** button to adjust the time. For instance if you want a delay time of one hour and thirty minutes you would enter a value of **01.30**.
8. Once you have the value you want, press **ENTER** and you will see **FiRE** again.
9. This will delay the start of the actual firing by the number of minutes and hours that you have chosen.
10. Press **ENTER** and the control will begin the firing cycle. If you have entered a delay, then you will see **dLY** flashing with a countdown of the time (for example **01:30** for 1 hour and 30 minutes)
11. Press the **REVIEW** button to review the program.
12. You can do this when you see the **FiRE** display (which will be before the kiln has started to fire) or while firing (when you just see temperature continuously).
13. The display will scroll though:
 - The name of the program (i.e. **bISC**)
 - Then **CndL** (for candle low fire followed by a time)
 - Then **COnE** followed by a number like **04**
 - Then **°F** or **°C** to let you know the temperature scale
 - Then a temperature like **1063** which is the anticipated maximum temperature.
 - Then **HLd** followed by a time value like **00:00**, which is any hold time at top temperature that you may have programmed into the control.
 - NOTE: Setting for **COOL** and **HtUP** are not shown so you need to make sure these are right before you fire your program.
14. Press **ENTER** anytime to stop the program.
15. When the program is complete, you will see **CPLt**.
16. If the Beep option has been turned to "On," then the control will beep about 15 times. If it was set for "OFF," then there will be no beeping. If it was set for "FULL," then it will beep until a button is pressed. (See Options

later in the manual for how to set this.)

9.2 SIMPLE WITH CHANGES (Bisque or Glaze)

1. It is easy to change simple options like candle time, cone to fire to, hold time at peak temperature, cool-down rate and heat-up rate (plus, you can restore the default values in case you lose track of where you are).

Note that the heat up rate is what changes a Bisque or a Glaze program to Slow, Medium or High.

9.2.1 TO CHANGE A SIMPLE OPTION

1. When you press **BISQUE** or **GLAZE** and hold it for 5 seconds, then you will see either **CndL**, **COnE**, **HLd**, **COOL**, **rStr**, or **HtUP**.
2. Once you see one of these displays remove your finger from the button. (NOTE: If you do not hit another button for 5 seconds the control will return to idle. If this happens just start over.)
3. Once you see any of these displayed options you can scroll to other displayed options by pressing the **UP** or **DOWN** button.
4. Here are the options you can change:

CndL	Candle Time (this is a low temperature firing used to dry moisture from the clay)
COnE	Cone to fire to (022 to 10)
HLd	Hold or Soak time at peak temperature in hours and minutes up to 99 hours and 99 minutes (Format: 00.00)
COOL	Cool down rate. OFF (natural cooling), SLO (Slow = 52°C/hour), MEd (Med = 121°C/hour), FASt (Fast = 260°C/hour)
rStr	Restore default original values
HtUP	Heat up rates. SLO (Slow), MEd (Medium), FASt (Fast). This is what changes the program to Slow, Medium or High. The rates depend on whether you are in Glaze or Bisque - see the programs later in the manual for details.

5. Once you see the what you want to change press **ENTER**.
6. Once you have entered a option to change, the **UP** and **DOWN** button will then allow adjustment of the value

OPERATION OF L&L KILNS WITH A ONE-TOUCH™ (Deg F)

of that particular option.

7. Once you see the value you want press **ENTER** to select and save.
8. The display will then cycle back to the starting display of the control. (You will see **IdLE** or **StOP** alternating with a display of the current kiln temperature).
9. To change another option go through the process again.
10. You can not change more than one option at a time.

9.2.2 EXAMPLE: CHANGE CONE OF BISQUE FIRE

Change the cone that the Bisque program goes to from **Δ04** to **Δ06**:

1. Press the **BISQUE** Button for 5 seconds or more.
2. See **CndL** or **COnE** or **HLd** or **COOL** or **rStr** or **HtUP**.
3. Release your finger from the button.
4. Scroll to **COnE** display by pressing the **UP** or **DOWN** button.
5. Press **ENTER** to change the value of the **COnE** option.
6. See **04** alternating with **COnE**
7. Press the **DOWN** button until you see **06**
8. Press **ENTER**
9. See either **IdLE** or **StOP** alternating with a display of the current kiln temperature.

9.2.3 EXAMPLE: CHANGE SPEED OF BISQUE FIRE

Change the speed of firing for the Bisque program from **Slow** to **Fast**.

1. Press the **BISQUE** Button for 5 seconds or more.
2. See **CndL** or **COnE** or **HLd** or **COOL** or **rStr** or **HtUP**.
3. Release your finger from the button.
4. Scroll to **HtUP** display by pressing the **UP** or **DOWN** button.
5. Press **ENTER** to change the value of the **HtUP** option.
6. See **SL0** alternating with **HtUP**
7. Press the **DOWN** button until you see **FAST**

8. Press **ENTER**

9. See either **IdLE** or **StOP** alternating with a display of the current kiln temperature.

Note - the temperatures, ramps and soak times that for the various preset bisque and glaze programs, are shown later on. These charts are for your reference only - when you are using the Simple mode of operation - you can not change any of those ramp and hold settings - just the overall grouping of ramps and holds that makes up the “slow”, “medium” and “fast” setting.

9.3 CUSTOM (Ramps and Holds):

1. Press **CUSTOM** and you have four Ramp/Soak programs available for sophisticated custom programming.
2. Each program has eight segments.
3. Each segment has a ramp, a temperature set point, and a hold time for each segment.
4. See “**CUSTOM RAMP/HOLD PROGRAMMING**” later in manual for detailed instructions on how to program in the Custom mode of operation.

10. RESETTING FACTORY DEFAULTS

It is natural, when first learning a new technology, to get confused or to put in something you are not sure of and then not know where the beginning is. If you do this and you want to go back to the factory defaults so you begin from scratch do the following:

1. Press the **BISQUE** Button for 5 seconds or more.
2. See **CndL** or **COnE** or **HLd** or **COOL** or **rStr** or **HtUP**
3. Release your finger from the button.
4. Scroll to **rStr** display by pressing the **UP** or **DOWN** button.
5. Press **ENTER** to change restore the control to its factory default values
6. See either **IdLE** or **StOP** alternating with a display of the current kiln temperature.
7. Repeat the same process for **GLAZE**

11. HOW TO CANCEL A FIRING

1. Just press **ENTER** while the kiln is firing.

OPERATION OF L&L KILNS WITH A ONE-TOUCH™ (Deg F)

- You will see either **IdLE** or **StOP** alternating with a display of the current kiln temperature.

12. STANDARD (SIMPLE) PROGRAMS

The following tables show you exactly how the control is set up so you can understand what is going on “under the hood”.

- You can not change the way the ramps, holds and temperature set points are set - if you need or want to do that then you need to use Custom Programming.
- The “Default Bisque Program” is a Slow Bisque and the “Default Glaze Program” is a Medium Glaze.
- “Slow”, “Medium” and “Fast” refer to the ramp speeds and lengths of the programs.
- When you change the speed of the Cooldown this goes from **OFF** (no controlled cooling or no heat at all when cooling), to **FASt** (Fast = 500°F/hour) **MEd** (Medium = 250°F/hour) to **SL0** (Slow = 125°F/hour).
- We recommend experimenting with slower cooldowns for interesting effects on glazing. It is usually irrelevant for bisquing.

12.1 STANDARD BISQUE PROGRAMS

Slow, Medium and Fast Settings for the Bisque programs are listed.

Note: Final temperatures are based on Orton cone charts (Small Self-Supporting Cones). For instance, Cone 04 is 1945°F and Cone 06 is 1828°F. The second-to-last temperature is the cone temperature minus 256°F. If you want to see the Orton Cone Chart go to hotkilns.com/orton-cone-chart.

Note: Seg 1 is the candling segment. This segment is skipped if the **CndL** option is set to “**00.00**”).

You can download an Excel spreadsheet that will generate any program (with graph and times) based on a particular cone number at hotkilns.com/one-touch-calculator.

Times are calculated assuming a room temperature of 70°F

12.1.1 Slow Bisque (Default Bisque Program)

Δ04 Standard Slow Bisque – SEGS-6 (6 segments)

Seg 1-	10.2 Hrs	RA1 - 25°F/Hr	° F1-150°F	HOLD- 7.0
Seg 2-	3.35 Hrs	RA2 - 100°F	° F2-185°F	HOLD- 3.0
Seg 3-	4.08 Hrs	RA3 - 200°F	° F3-1000°F	HOLD- 00.00

Seg 4-	1.00 Hrs	RA4 - 100°F	° F4-1100°F	HOLD- 00.00
Seg 5-	2.95 Hrs	RA5 - 200°F	° F5-1689°F	HOLD- 00.00
Seg 6-	2.37 Hrs	RA6 - 108°F	° F6-1945°F	HOLD- 00.00
TOTAL FIRING TIME = 23.94 HRS				

12.1.2 Medium Speed Bisque

Δ04 Standard Medium Bisque – SEGS-6 (6 segments)

Seg 1-	1.00 Hrs	RA1 - 80°F	° F1-150°F	HOLD- 00.00
Seg 2-	0.44 Hrs	RA2 - 80°F	° F2-185°F	HOLD- 00.00
Seg 3-	0.81 Hrs	RA3 - 80°F	° F3-250°F	HOLD- 00.00
Seg 4-	3 Hrs	RA4 - 250°F	° F4-1000°F	HOLD- 00.00
Seg 5-	3.83 Hrs	RA5 - 180°F	° F5-1689°F	HOLD- 00.00
Seg 6-	2.37 Hrs	RA6 - 108°F	° F6-1945°F	HOLD- 00.00
TOTAL FIRING TIME = 10.45 HRS				

12.1.3 Fast Speed Bisque

Δ04 Standard Fast Bisque – SEGS-6 (6 segments)

Seg 1-	0.53 Hrs	RA1 - 150°F	° F1-150°F	HOLD- 00.00
Seg 2-	0.23 Hrs	RA2 - 150°F	° F2-185°F	HOLD- 00.00
Seg 3-	0.43 Hrs	RA3 - 150°F	° F3-250°F	HOLD- 00.00
Seg 4-	2.83 Hrs	RA4 - 300°F	° F4-1100°F	HOLD- 00.00
Seg 5-	1.47 Hrs	RA5 - 400°F	° F5-1689°F	HOLD- 00.00
Seg 6-	2.37 Hrs	RA6 - 108°F	° F6-1945°F	HOLD- 00.00
TOTAL FIRING TIME = 7.54 HRS				

12.2 STANDARD GLAZE PROGRAMS

Slow, Medium and Fast Settings for the Glaze programs are listed.

Note: Final temperatures are based on Orton cone charts (Small Self-Supporting Cones). For instance, Cone 04 is 1945°F and Cone 06 is 1828°F. The second-to-last temperature is the cone temperature minus 256°F. If you want to see the Orton Cone Chart go to hotkilns.com/orton-cone-chart.

Note: Seg 1 is the candling segment. This segment is skipped if the **CndL** option is set to “**00.00**”).

You can download an Excel spreadsheet that will generate any program (with graph and times) based on a particular cone number at hotkilns.com/one-touch-calculator.

Times are calculated assuming a room temperature of 70°F

OPERATION OF L&L KILNS WITH A ONE-TOUCH™ (Deg F)

12.2.1 Slow Glaze

Δ06 Slow Glaze – SEGS–3 (3 segments)

Seg 1- 0.45 Hrs RA1 - 400°F ° F1–250°F HOLD- 00.00

Seg 2- 3.31 Hrs RA2 - 400°F ° F2–1572°F HOLD- 00.00

Seg 3- 2.00 Hrs RA3 - 128°F ° F3–1828°F HOLD- 00.00

TOTAL FIRING TIME = 5.31 HRS

12.2.2 Medium Glaze (Default Glaze Program)

Δ06 Medium Glaze – SEGS–3 (3 segments)

Seg 1- 0.29 Hrs RA1 - 400°F ° F1–185°F HOLD- 00.00

Seg 2- 3.76 Hrs RA2 - 400°F ° F1–1572°F HOLD- 00.00

Seg 3- 1.71 Hrs RA3 - 150°F ° F2–1828°F HOLD- 00.00

TOTAL FIRING TIME = 5.17 HRS

12.2.3 Fast Glaze

Δ06 Fast Glaze – SEGS–3 (3 segments)

Seg 1- 0.20 Hrs RA1 - 570°F ° F1–185°F HOLD- 00.00

Seg 2- 2.43 Hrs RA2 - 570°F ° F2–1572°F HOLD- 00.00

Seg 3- 1.28 Hrs RA3 - 200°F ° F3–1828°F HOLD- 00.00

TOTAL FIRING TIME = 3.71 HRS

12.3 SIMPLE COOL DOWN SPEEDS

Note: These are entered as one of the simple options in the Simple Programming (COOL).

Cool Down options are as follows:

1. Slow = 125°F/hour
2. Med = 250°F/hour
3. Fast = 500°F/hour

13. CUSTOM RAMP/HOLD PROGRAMMING

1. Each fully customizable program has eight segments.
2. Each segment has a ramp rate, a hold time and a temperature set point.
3. Ramp Rate is some number of degrees centigrade per hour either increasing or decreasing in temperature. For example a ramp rate of 27 means that the program will move from the temperature at the beginning of the segment to the temperature at the end of the segment at 27 degrees centigrade per hour.

4. Hold time is a time that the program holds the temperature reached at the end of the segment. It can be set for 00.00 and, in fact, in most cases is.
5. The temperature set point is the final temperature intended to be reached in the segment.
6. At the end of the segment, i.e. when the program reached the temperature set point and finishes any hold time the control will move to the next segment. If it is the last segment then the program will be complete (CPLt).

13.1 REUSE A PREVIOUS PROGRAM

1. Start with the display reading IdLE and flashing a temperature or StOP and temperature.
2. Select CUSTOM
3. See CUS t
4. Press ENTER
5. You will see CUS1, CUS2, CUS3 or CUS4.
6. These are the four custom programs.
7. You can scroll to other ones with the UP and DOWN button.
8. When the display shows the one you want to select press ENTER.
9. After you have selected your program with ENTER press the REVIEW button.
10. This will scroll through all the segments so you can see what is programmed in that custom program and the end up with FIrE. Press ENTER when you see FIrE and the program will start.

13.2 CHANGING A PROGRAM (STEP BY STEP)

13.2.1 START

1. Start with the display reading IdLE and flashing a temperature or StOP and temperature.

13.2.2 CHOOSE CUSTOM PROGRAMMING

1. Select CUSTOM
2. See CUS t
3. Press ENTER

OPERATION OF L&L KILNS WITH A ONE-TOUCH™ (Deg F)

13.2.3 PICK A PROGRAM

1. You will see **CUS1**, **CUS2**, **CUS3** or **CUS4**.
2. These are the four custom programs.
3. You can scroll to other ones with the **UP** and **DOWN** button.
4. When the display shows the one you want to select press **ENTER**.

13.2.4 SPECIFY NUMBER OF SEGMENTS

1. Once you have chosen a program, you need to specify the total number of segments that you will use.
2. All programs consist of 1 or more segments, as shown in the sample profiles in this manual.
3. Each segment has 3 parts: a ramp rate (speed of temperature rise in degrees centigrade per hour), hold temperature (in degrees centigrade), and hold time (in hours and minutes) at the hold temperature.
4. It is helpful to draw your profile to see how many segments you will need.
5. Then, use the **UP** and **DOWN** buttons to display the desired number of segments, and press **ENTER** to store the value when you see the number you want.

13.2.5 ENTER RAMP RATE

1. You will see **rA1**, followed by a value like **150**.
2. The **rA1** stands for Ramp One.
3. The value represents a rate of temperature rise expressed in degrees per hour.
4. Use the arrow buttons to adjust the rate and press **ENTER** to store the value.
5. To help you visualize what is typical of various ramps read the following:
6. Slow rates range from 1-50 degrees per hour, and are used for thick glass projects.
7. Medium rates range from 60 to 200 degrees per hour, and are used for thick, hand-built ceramics.
8. Fast rates range from 250–1000 degrees per hour, and are used for glazes, thin ceramics and small glass projects.
9. A rate of **9999** sets the kiln to ramp as fast as possible.
10. Also, see the various ramps in the standard programs

for an idea of what works.

13.2.6 ENTER HOLD TEMPERATURE

1. You will see **°F1** followed by a value like **0300**.
2. The **°F1** stands for Temperature One.
3. For a single segment program, this is the top temperature of the firing.
4. For multi-segment programs, this can be a temperature where you want to hold to dry the ware or for carbon burn-out, or to equalize the temperature across the item or it can be where you just want to switch ramp rates without a hold.
5. Adjust the temperature with the **UP** and **DOWN** buttons and press **ENTER** to store the displayed value.

13.2.7 ENTER HOLD TIME

1. You will see **HLd1** followed by a value like **00:00**.
2. The **HLd1** stands for Hold One.
3. Hours are displayed to the left of the decimal point and minutes to the right (HH.mm).
4. Use the **UP** and **DOWN** buttons to adjust the hold time at the soak temperature.
5. Use a zero (**00.00**) hold time if you just want to move to the next segment.
6. Drying ware can take several hours, while holds at peak temperature usually range 10–15 minutes to even out the kiln. Feel free to experiment - there is no one right way to program a kiln.

13.2.8 REPEAT STEPS FOR EACH SEGMENT

1. For segment two, the display will read **rA2**, **°F2** and **HLd2**
2. For segment three, the display will read **rA3**, **°F3** and **HLd3** etc.

13.2.9 SET A DELAY (OPTIONAL - CAN BE SKIPPED)

1. If you want to set a delay, you can do it when the display says **FirE**.
2. You can add a delay time to the program by pressing the **DOWN** arrow when you see **FirE** but before you press **ENTER**.
3. After you press the **DELAY** button you will see **dELA** flashing with a time value, typically **00.00** which

OPERATION OF L&L KILNS WITH A ONE-TOUCH™ (Deg F)

represents 00 hours and 00 minutes.

4. After you see this flashing display, you can press the **UP** or **DOWN** button to adjust the delay time.
5. Once you see the value you want, press **ENTER** and you will see **FIrE** again.
6. This will delay the start of the actual firing by the number of minutes and hours that you have chosen.

13.2.10 START FIRING!

1. The display will show **FIrE** (ready to fire) when all segments have been entered.
2. Press **ENTER** to start the firing.

Caution should be taken to make sure that no one can place anything around or on the kiln during the delay start. Treat the kiln as firing during the delay start.

13.2.11 REVIEW PROGRAM

1. Press the **REVIEW** button to review the program.
2. You can do this when you see the **FIrE** display, **CUS1**, **CUS2**, **CUS3**, **CUS4** or while firing.
3. The display will scroll though and show you the following:
4. The name of the program (i.e. **CUS4**)
5. Then the number of segments (i.e. **2**)
6. Then all the ramps, temperatures and holds in sequence.

13.2.12 COMPLETE THE FIRING

1. When the firing is complete, you will see **CPLt**.
2. If the Beep option has been turned to “**On**” then the control will beep about 15 times. If it was set for “**OFF**,” then there will be no beeping. If it was set for “**FULL**,” it will beep until a button is pressed. (See Options later in the manual for how to set this.)

14. KILN OPERATION DURING A CUSTOM FIRING PROGRAM

14.1 DESCRIPTION

1. At the start of a firing, the controller sets its moving set-point to the current temperature in the kiln.
2. The moving set-point is where the controller wants the kiln temperature to be.

3. The controller will then move the moving set-point up at the programmed rate, and cycle power to the elements to make the temperature of the kiln follow the moving set-point.
4. You will hear the relays clicking to regulate the kiln temperature.
5. The elements will receive power when the temperature is below the moving set-point.
6. The relays will click off when the temperature is above the moving set-point.
7. The current segment and moving set-point can be viewed by pressing the **UP** arrow during a firing.
8. The control can not make the kiln go any faster than it is capable of so there may be a lag between what the control wants to do and what the kiln can do. This is normal and is only of concern if the kiln starts firing slower than it normally has done in the past.

14.2 OPTIONS DURING FIRING

14.2.1 DISPLAYING THE CURRENT SET-POINT AND ACCESSING THE FOLLOWING OPTIONS

1. During a firing, you may advance from the current segment to the next ramp rate by using **Skip Step (SStP)**; or, if you are in a hold period, you may add time (**tME**) and temperature (**tMP**) to the hold period.
2. When the **UP** button is pressed during a firing, the current ramp or hold is displayed, followed by the current or moving set-point, then **SStP** is displayed.
3. If you do not press a button within several seconds, the display will return to showing the current temperature in the kiln.

14.2.2 SKIP STEP

1. This option allows you to skip from the present segment to the next ramp rate.
2. Press the **UP** button, the display will show the current segment, then the set-point, then **SStP**.
3. When **SStP** is displayed, press **ENTER** to skip to the next ramp rate.

14.2.3 ADD TIME TO HOLD PERIOD

1. This is available only during a hold period.
2. This option allows you to add time in 5 minute

OPERATION OF L&L KILNS WITH A ONE-TOUCH™ (Deg F)

increments to a hold (soak) period.

3. During a hold or soak, the temperature in the kiln will be alternating in the display with the remaining hold time.
4. When in a hold period, press the **UP** button.
5. When **SStP** is displayed, press the **UP** button again and **tME** will be displayed.
6. Press **ENTER** and 5 minutes will be added to the hold time.
7. You may use this procedure as many times as necessary to get the hold time that you want.

14.2.4 ADD TEMPERATURE TO HOLD PERIOD

1. This is available only during a hold period.
2. This option allows you to add temperature in 5 degree increments to a hold (soak) period.
3. During a hold or soak, the temperature in the kiln will be alternating in the display with the remaining hold time.
4. When in a hold period, press the **UP** button.
5. When **SStP** is displayed, press the **UP** button twice more and **tMP** will be displayed.
6. Press **ENTER** and 5 minutes will be added to the hold time.
7. You may use the add temperature procedure as many times as necessary to get the hold temperature desired.

15. CUSTOM PROGRAMS

There are the four programs (shown in Degrees F) that can be fully customized.

Three of these have been preprogrammed by the factory to simplify the first firing process.

Once this process has been completed they may be reprogrammed anyway you like.

15.1 CUSTOM PROGRAM 1

Standard First Firing Program:

A5 Standard Slow Bisque – SEGS–5 (5 segments)

Seg 1-	2.15 Hrs	RA1 - 80°F	° F1–250°F	HOLD- 00.00
Seg 2-	3.75 Hrs	RA2 - 200°F	° F2–1000°F	HOLD- 00.00
Seg 3-	1.00 Hrs	RA3 - 100-°F	° F3–1100°F	HOLD- 00.00
Seg 4-	4.58 Hrs	RA4 - 180-°F	° F4–1915°F	HOLD- 00.00

Seg 5- 3.12 Hrs RA5 - 80-°F ° F5–2165°F HOLD- 00.00

TOTAL FIRING TIME = 15.6 HRS

15.2 CUSTOM PROGRAM 2

Split First Firing (First Segment):

Seg 1-	2.15 Hrs	RA1 - 80°F	° F1–250°F	HOLD- 00.00
Seg 2-	3.75 Hrs	RA2 - 200°F	° F2–1000°F	HOLD- 00.00
Seg 3-	1.00 Hrs	RA3 - 100-°F	° F3–1100°F	HOLD- 00.00
Seg 4-	2.22 Hrs	RA4 - 180-°F	° F4–1500°F	HOLD- 00.00

TOTAL FIRING TIME = 9.12 HRS

15.3 CUSTOM PROGRAM 3

Split First Firing (Second Segment):

Seg 1-	0.85 Hrs	RA1 - 200°F	° F1–250°F	HOLD- 00.00
Seg 2-	2.50 Hrs	RA2 - 500°F	° F2–1500°F	HOLD- 00.00
Seg 3-	2.30 Hrs	RA3 - 180-°F	° F3–1915°F	HOLD- 00.00
Seg 4-	3.12 Hrs	RA4 - 80-°F	° F4–2165°F	HOLD- 00.00

TOTAL FIRING TIME = 8.77 HRS

15.4 CUSTOM PROGRAM 4

Blank - nothing is preprogrammed.

16. OPTIONS

16.1 ACCESSING OPTIONS

1. Options are accessed by holding the **ENTER** button while turning the power onto the control (by turning on the kiln with the toggle switch) and continuing to hold onto the **ENTER** button until **EdIt** is displayed.
2. This activates the Options Menu.
3. The first thing you will see after turning the power on while pressing **ENTER** is **LL-G** or **It-I** (This is the software version).
4. Then you will see **2350** if it is a Cone 10 control or **2280** if it is a Cone 6 control.
5. Then you will see **EdIt** and you will hear a beep. You can now let go of the **ENTER** button.

16.2 OPTIONS

16.2.1 SOUND: BEEPING ON OR OFF AT END OF PROGRAM

1. The first thing to change is the action of the beeper.

OPERATION OF L&L KILNS WITH A ONE-TOUCH™ (Deg F)

2. **OFF** turns off the beeper.
3. **FULL** makes the beeper stay on until any button is pushed.
4. **On** makes the beeper sound 15 times and then turn off.
5. If you don't want to change this option then press **ENTER**.

16.2.2 MAXIMUM TEMPERATURE

1. **On a Cone 6 Version (School-Master): Maximum Temperature** (Deg C) **1700**, **2000**, and **2280** are options.
2. **On a Cone 10 Version (Liberty-Belle, Doll, Fuego, Robin):** Cone 10 models have a preset maximum temperature limit of **2350** and you will not see the "Maximum Temperature" option come up.

16.2.3 TEMPERATURE INDICATION

1. **°F** (Deg F) or **°C** (Deg C).
2. When you are in Deg C, you will always see a little dot in the display at the bottom right to remind you.
3. Use the **UP** or **DOWN** button to change the value and then press **ENTER**.

16.2.4 THERMOCOUPLE OFFSET

1. **OFFS** (+/- deg F)
2. Display shows **OFFS**.
3. Press the **UP** arrow to enter a positive offset.
4. Press the **DOWN** arrow to add a negative sign to the offset, and then the **UP** arrow to add negative offset to the control.
5. The control comes with a pre-programmed +18 Deg F offset to compensate for the thermocouple protection tube.
6. Note: if you first press the **DOWN** button you can only set a negative value or if you first press the **UP** button you can only enter a positive value.
7. You can go back and change this later if you make a mistake.

Note: you can adjust how the kiln fires by adjusting the thermocouple offset. For instance, if your kiln is firing cool (according to a witness cone placed in the kiln) then you can add positive Offset. If it is firing hot then you can reduce the offset or put in a negative offset. Try doing this in 5 degree

increments.

17. MESSAGES & DISPLAYS

CndL Candle Time (this is a low temperature firing used to dry moisture from the clay)

COnE Cone to fire to

COOL Cool down rate. **OFF** (natural cooling), **SLO** (Slow), **MEd** (Medium), **FAST** (Fast)

CPLt Firing Cycle Complete (firing time is alternately displayed).

dELA Delay. Displays when entering the delay time (hour:minutes) until the start of the firing.

DLy Delay. Alternates with the remaining delay time until the start of the kiln.

°F# Segment temperature in °F—Set temperature for a user program. (# stands for numbers 1 through 8)

°C# Segment temperature in °C – Set temperature for a user program. A decimal point will display in lower right corner. (# stands for numbers 1 through 8)

Edit Edit the default options (beeping at complete, temperature scale, cone fire, delay, maximum programmable temperature)

ErrP There has been a power interruption that has stopped the firing. Press any button to clear.

FAST Fast (Heat up or Cool down rate)

FiRE Ready to fire current program. Press **START** to begin firing.

FULL Beeps continuously at end of firing until a button is pressed.

HtUP Heat up rates. **SLO** (Slow), **MEd** (Medium), **FAST** (Fast)

HLd Hold or Soak time at peak temperature

HLd# Soak time in hours:minutes at a hold temperature. (# stands for numbers 1 through 8)

IdLE This shows up when the control is not firing or is not being programmed. Message alternates with the current kiln temperature. Similar to **StOP**.

1t-1 This comes on when you first turn on the control if it is a Cone 10 control.

LL-6 This comes on when you first turn on the control if it is a Cone 6 control.

OPERATION OF L&L KILNS WITH A ONE-TOUCH™ (Deg F)

- MEd** Medium (Heat up or Cool down rate)
- OFF** No beeping when firing is complete. Or could be that an option is off when setting options. Also used to show that Cooling is off.
- On** Beeps for 15 seconds at end of firing.
- rA#** Ramp Number (rate per hour of temperature increase or decrease). (# stands for numbers 1 through 8)
- rStr** Restore default original values
- SEG** Short for Segments. You can enter up to 8 segments in a program.
- SLO** Slow (Heat up or Cool down rate)
- SStP** Skip Step (used to advance to the next ramp)
- StOP** The kiln is at idle and ready to be programmed. Message alternates with the current kiln temperature.
- CUS1, CUS2, CUS3, CUS4** Custom program number displayed.

18. ERROR CODES

tC FAIL **tC** alternating with **FAIL** indicates the thermocouple has failed. Replace the defective thermocouple. To clear the error, press any key.

Errd Displayed whenever the kiln temperature is 100°F (38°C) above the traveling set-point, which is the current desired temperature in the kiln. The traveling set-point will increase or decrease according to the programmed rate.

Errl Displayed whenever the kiln temperature is rising during an up ramp slower than 15°F/hr. (9°C/hr) If this rate continues for 8 minutes the firing will be stopped. **Errl** may be an indication that the elements are worn or that a relay has stopped working.

ErrP Displayed whenever there is a power interruption that is long enough to stop the firing. If the power interruption is brief, the kiln will continue to fire when power is restored; in this case, there will be no indication of a power failure. To clear the error, press any key.

ErrF Displayed whenever the kiln temperature is decreasing during a down ramp slower than 15°F/hr (9°C/hr). If this rate continues for 8 minutes the firing will be stopped. **ErrF** may be an indication that a relay has stuck in the on position.

tC-- The red and yellow thermocouple wires are reversed.

19. SOFTWARE VERSION

These instructions apply to software version **LL-G** for the Cone 6 version of the control or **lt-l** for the Cone 10 version of the control. You will see this code flash when you first turn on the control.

20. CENTIGRADE INSTRUCTIONS

These instructions are available in a Fahrenheit version. *Go to hotkilns.com/basic-one-touch-c*

21. SPECIFICATIONS

Go to hotkilns.com/one-touch-specifications

LIBERTY-BELLE INSTRUCTION MANUAL

LOG, CONES, TIPS,
CERAMIC PROCESS

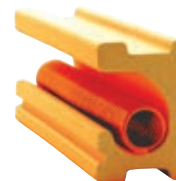

L&L Kiln's patented
hard ceramic
element holders
protect your kiln.

Temperature Equivalent Chart for Orton Pyrometric Cones (° F) Cone Numbers 022-14



Cone	Self Supporting Cones						Large Cones			Small
	Regular		Iron Free		Iron Free		Regular	Iron Free	Regular	Regular
	27	108	270	27	108	270	108	270	108	540
	<i>Heating Rate ° F/hour (last 180° F of firing)</i>									
022	1087	1094	N/A	N/A	N/A	N/A	1166			
021	1112	1143	N/A	N/A	N/A	N/A	1189			
020	1159	1180	N/A	N/A	N/A	N/A	1231			
019	1213	1252	1283	1249	1279	1333				
018	1267	1319	1353	1314	1350	1386				
017	1301	1360	1405	1357	1402	1443				
016	1368	1422	1465	1416	1461	1517				
015	1382	1456	1504	1450	1501	1549				
014	1395	1485	1540	1485	1537	1598				
013	1485	1539	1582	1539	1578	1616				
012	1549	1582	1620	1576	1616	1652				
011	1575	1607	1641	1603	1638	1679				
010	1636	1657	1679	1600	1627	1639	1648	1675	1623	1636
09	1665	1688	1706	1650	1686	1702	1683	1702	1683	1699
08	1692	1728	1753	1695	1735	1755	1728	1749	1733	1751
07	1764	1789	1809	1747	1780	1800	1783	1805	1778	1796
06	1798	1828	1855	1776	1816	1828	1823	1852	1816	1825
05½	1839	1859	1877	1814	1854	1870	1854	1873	1852	1868
05	1870	1888	1911	1855	1899	1915	1886	1915	1890	1911
04	1915	1945	1971	1909	1942	1956	1940	1958	1940	1953
03	1960	1987	2019	1951	1990	1999	1987	2014	1989	1996
02	1972	2016	2052	1983	2021	2039	2014	2048	2016	2035
01	1999	2046	2080	2014	2053	2073	2043	2079	2052	2070
1	2028	2079	2109	2046	2082	2098	2077	2109	2079	2095
2	2034	2088	2127				2088	2124		
3	2039	2106	2138	2066	2109	2124	2106	2134	2104	2120
4	2086	2124	2161				2120	2158		
5	2118	2167	2205				2163	2201		
5½	2133	2197	2237				2194	2233		
6	2165	2232	2269				2228	2266		
7	2194	2262	2295				2259	2291		
8	2212	2280	2320				2277	2316		
9	2235	2300	2336				2295	2332		
10	2284	2345	2381				2340	2377		
11	2322	2361	2399				2359	2394		
12	2345	2383	2419				2379	2415		
13	2389	2428	2458				2410*	2455*		
14	2464	2489	2523				2491*	2530*		

Pyrometric cones have been used to monitor ceramic firings for more than 100 years. They are useful in determining when a firing is complete, if the kiln provided enough heat, if there was a temperature difference in the kiln or if a problem occurred during the firing.

Cones are made from carefully controlled compositions. They bend in a repeatable manner (over a relatively small temperature range - usually less than 40° F). The final bending position is an indication of how much heat was absorbed.

Behavior of Pyrometric Cones

Typically, it takes 15 to 25 minutes for a cone to bend once it starts. This depends on the cone number. The cone bends slowly at first but once it reaches the half way point (3 o'clock), it bends quickly. When the cone tip reaches a point level with the base, it is considered properly fired. This is the point for which temperature equivalents are determined. Differences between a cone touching the shelf and a cone at the 4 o'clock position are small, usually 1 or 2 degrees.

Temperatures shown on the charts were determined under controlled firing conditions in electric kilns and an air atmosphere. Temperatures are shown for specific heating rates. These heating rates are for the last 100° C or 180° F of the firing. Different heating rates will change the equivalent

temperature. The temperature will be higher for faster heating rates and lower for slower heating rates.

Cone bending may also be affected by reducing atmospheres or those containing sulfur oxides. Orton recommends the use of Iron-Free cones for all reduction firings (cones 010-3). If a cone is heated too fast, the cone surface fuses and binders used to make cones form gases that bloat the cone. If cones are to be fired rapidly, they should be calcined (pre-fired) before use. Cones should be calcined to about 850° F (455° C) in an air atmosphere.

If a cone is soaked at a temperature near its equivalent temperature, it will continue to mature, form glass and bend. The time for the cone to bend depends on several factors and as a general rule, a 1 to 2 hour soak is sufficient to deform the next higher cone number. A soak of 4 to 6 hours will be required to deform two higher (hotter) cones.

For more information on pyrometric cones, contact Orton or visit us at www.ortonceramic.com

The Edward Orton Jr. Ceramic Foundation
 P.O. Box 2760 • Westerville, OH 43086-2760
 (614) 895-2663 • (614) 895-5610 fax
info@ortonceramic.com
www.ortonceramic.com

These tables provide a guide for the selection of cones. The actual bending temperature depends on firing conditions. Once the appropriate cones are selected, excellent, reproducible results can be expected. Temperatures shown are for specific mounted height above base. For Self Supporting - 1 3/4"; for Large - 2"; for Small - 1 5/16". For Large Cones mounted at 1 3/4" height, use Self Supporting temperatures. * These Large Cones have different compositions and different temperature equivalents.

Temperature Equivalent Chart for Orton Pyrometric Cones (°C) Cone Numbers 022-14



Cone	Self Supporting Cones					Large Cones			Small Regular
	Regular		Iron Free			Regular		Iron Free	
	15	60	150	15	60	150	60	150	
	Heating Rate °C/hour (last 100° C of firing)								
022	586	590	N/A	N/A	N/A	N/A	60	150	300
021	600	617	N/A	N/A	N/A	N/A			630
020	626	638	N/A	N/A	N/A	N/A			643
019	656	678	695	676	693	676	693	693	666
018	686	715	734	712	732	712	732	732	723
017	705	738	763	736	761	736	761	761	752
016	742	772	796	769	794	769	794	794	784
015	750	791	818	788	816	788	816	816	825
014	757	807	838	807	836	807	836	836	843
013	807	837	861	837	859	837	859	859	870
012	843	861	882	858	880	858	880	880	880
011	857	875	894	873	892	873	892	892	900
010	891	903	915	898	913	898	913	913	915
009	907	920	930	917	928	917	928	928	919
008	922	942	956	942	954	942	954	954	955
007	962	976	987	973	985	973	985	985	983
006	981	998	1013	995	1011	995	1011	1011	1008
05½	1004	1015	1025	1012	1023	1012	1023	1023	1023
005	1021	1031	1044	1013	1037	1030	1046	1046	1043
004	1046	1063	1077	1043	1061	1060	1070	1070	1062
003	1071	1086	1104	1066	1088	1086	1101	1101	1098
002	1078	1102	1122	1084	1105	1101	1120	1120	1131
001	1093	1119	1138	1101	1123	1117	1137	1137	1148
1	1109	1137	1154	1119	1139	1136	1154	1154	1178
2	1112	1142	1164	1130	1154	1142	1162	1162	1184
3	1115	1152	1170	1130	1162	1152	1168	1168	1190
4	1141	1162	1183	1130	1181	1160	1181	1181	1196
5	1159	1186	1207	1184	1205	1184	1205	1205	1209
5½	1167	1203	1225	1201	1223	1201	1223	1223	1221
6	1185	1222	1243	1220	1241	1220	1241	1241	N/A
7	1201	1239	1257	1237	1255	1237	1255	1255	1255
8	1211	1249	1271	1247	1269	1247	1269	1269	1264
9	1224	1260	1280	1257	1278	1257	1278	1278	1300
10	1251	1285	1305	1282	1303	1282	1303	1303	1317
11	1272	1294	1315	1293	1312	1293	1312	1312	1330
12	1285	1306	1326	1304	1324	1304	1324	1324	1336
13	1310	1331	1348	1321*	1346*	1321*	1346*	1346*	1355
14	1351	1365	1384	1366*	1388*	1366*	1388*	1388*	N/A

Pyrometric cones have been used to monitor ceramic firings for more than 100 years. They are useful in determining when a firing is complete, if the kiln provided enough heat, if there was a temperature difference in the kiln or if a problem occurred during the firing.

Cones are made from carefully controlled compositions. They bend in a repeatable manner (over a relatively small temperature range - usually less than 40° F). The final bending position is an indication of how much heat was absorbed.

Behavior of Pyrometric Cones

Typically, it takes 15 to 25 minutes for a cone to bend once it starts. This depends on the cone number. The cone bends slowly at first but once it reaches the half way point (3 o'clock), it bends quickly. When the cone tip reaches a point level with the base, it is considered properly fired. This is the point for which temperature equivalents are determined. Differences between a cone touching the shelf and a cone at the 4 o'clock position are small, usually 1 or 2 degrees.

Temperatures shown on the charts were determined under controlled firing conditions in electric kilns and an air atmosphere. Temperatures are shown for specific heating rates. These heating rates are for the last 100° C or 180° F of the firing. Different heating rates will change the equivalent

temperature. The temperature will be higher for faster heating rates and lower for slower heating rates.

Cone bending may also be affected by reducing atmospheres or those containing sulfur oxides. Orton recommends the use of Iron-Free cones for all reduction firings (cones 010-3). If a cone is heated too fast, the cone surface fuses and binders used to make cones form gases that bloat the cone. If cones are to be fired rapidly, they should be calcined (pre-fired) before use. Cones should be calcined to about 850° F (455° C) in an air atmosphere.

If a cone is soaked at a temperature near its equivalent temperature, it will continue to mature, form glass and bend. The time for the cone to bend depends on several factors and as a general rule, a 1 to 2 hour soak is sufficient to deform the next higher cone number. A soak of 4 to 6 hours will be required to deform two higher (hotter) cones.

For more information on pyrometric cones, contact Orton or visit us at www.ortonceramic.com



The Edward Orton Jr. Ceramic Foundation
 P.O. Box 2760 • Westerville, OH 43086-2760
 (614) 895-2663 • (614) 895-5610 fax
info@ortonceramic.com
www.ortonceramic.com

These tables provide a guide for the selection of cones. The actual bending temperature depends on firing conditions. Once the appropriate cones are selected, excellent, reproducible results can be expected. Temperatures shown are for specific mounted height above base. For Self Supporting - 1 3/4"; for Large - 2"; for Small - 1 5/16". For Large Cones mounted at 1 3/4" height, use Self Supporting temperatures. * These Large Cones have different compositions and different temperature equivalents.

TROUBLESHOOTING KILN FIRING WITH CONE PACKS

BASIC CONE INFORMATION

PYROMETRIC CONES

Pyrometric cones are made of clay and other minerals and are precisely formulated to soften when fired in a kiln. They will bend over when they have absorbed a certain amount of heat. The amount of heat is related to both time and temperature. They mirror fairly accurately what goes on in a ceramic body and can be a more reliable guide to firing than a thermocouple instrument.

Differing materials in the cones result in different firing temperatures. The cones you are likely to use in an L&L kiln are numbered from Cone 022 to Cone 10 (coldest to hottest). The number is imprinted on the cone. Usually clay and glaze comes with a recommended cone to fire to. A cone is a tall (about 2-1/2") pyramid made from specific damp-pressed ceramic materials. Each cone has a slight lean to it when placed on a flat surface. Be careful not to drop cones or expose cones to moisture.

CONES MEASURE HEAT-WORK

Cones are not temperature measuring devices. They measure how much heat has been absorbed by the ware in the kiln, which is the result of the combination of time and temperature. A particular piece of clay needs a certain amount of time at a specific temperature to properly fire it, lower temperature if the time is longer, higher temperature if the time is shorter. An example of this would be if you added about a 20 minute hold to the maximum temperature of a cone 6 firing, you would be able to lower that final temperature by about 20°F. An hour hold time would mean a final temperature of about 40°F lower. A two hour hold time, about 60°F lower.

LARGE SELF SUPPORTING CONES

Although there are various types of cones available we recommend using the "self-supporting large cones". They have a built-in base that allows the cone to sit flat while always placing the pyramid part of it at the proper angle. The angle is there to ensure that the cone bends in the direction you want it to, and doesn't just slump and puddle.

CONE PACKS

The best way to use the cones, especially if they are all you have to tell how hot your kiln is getting, is to use 'cone packs', or the three cone system. The three cones are placed in a line, aimed so that when they fall, they will fall in a line. The first cone to fall should be in the front of the three cone line. This cone should be one cone number lower than the one you wish to fire to. The target cone (the cone you wish to fire to) should be the next one to fall and should be in the middle. The last

cone should be one cone number higher than the target cone. The first cone is to warn you that the firing is almost done. The target cone tells you when to turn off the kiln, and the last cone tells you if the kiln got hotter than you thought it did.



Picture of a "cone pack" (Courtesy of Orton). The ones in the back are before the firing and the ones in the front are after a perfect firing! These are Self-Supporting Large Cones.

USE CONES TO CONTROL ACCURACY IN AN AUTOMATIC KILN

We recommend checking the accuracy of your control and thermocouples every so often by placing at least one large cone (the target cone or cone number you are firing to) in the top, middle and bottom. Thermocouples will drift in their accuracy, but you can adjust the cone offset or thermocouple offset (or both) to compensate for this. You know how many degrees off the thermocouple reads at the end of the firing. Using a cone near the thermocouple and a "cone to temperature chart" will help to calibrate a thermocouple accurately. Remember though, cone temperatures are affected by their location in the kiln, the angle at which they are held, and the rate at which they are heated. Slight variations throughout the kiln should be expected. You can see a "cone to temperature" chart in the LOG, CONES, TIPS, CERAMIC PROCESS section of your manual or at hotkilns.com/orton-cone-chart.

TROUBLESHOOTING FIRING PROBLEMS

Seems like the kiln is under-firing or over-firing slightly

1) On the next firing make up "cone packs", one for each thermocouple. A cone pack is a set of three cones, standing in a line. The cone the firing should go to is called the target cone, and is in the middle. The one in front of it is one cone

TROUBLESHOOTING KILN FIRING WITH CONE PACKS

number lower, and the one behind it is one cone number higher. Pay attention to how you position the cones as they are designed to only fall in one particular direction if placed on a level surface. You do not want a lower-numbered cone stuck in the cone pack behind a higher-numbered cone because the lower-numbered one will fall first and might lean against or knock over the higher-numbered cone, which will compromise the accuracy of both cones.

2) Once the cone packs are positioned on shelves (or on a post lying on its side) and are visible through the peepholes, fire the kiln to the middle cone's number.

3) Near the end of the firing start watching the cone packs. Look for the first cone to fall over in each pack, not necessarily at the same time, but pretty close, probably in the middle zone first.

4) Now watch for the middle cone in each pack. Keep checking the DynaTrol display to be sure it does not say **CPLt**. The middle cone in each pack should start to fall at pretty much the same time in the top, middle and bottom of the kiln. When the tip of the cone touches the melted cone in front of it note the temperature readout on the display for that zone's thermocouple.

a) If the middle cones did not go down together then immediately note the differences in each thermocouple reading from the one thermocouple in the same zone as the first cone that went down. Later on, use the "thermocouple offset" feature to add or subtract degrees from each thermocouple accordingly. Use the differences between the thermocouple readings as a guide to know how much to offset each thermocouple.

b) If the three thermocouple temperatures are close enough to be reading the same thing (the middle cones did all go over at the same time), then the kiln should say **CPLt** right when the cone tips bend over and touch or just before it. If the kiln is still firing after this point, note how many degrees higher it goes before shutting itself off. Then use the "cone offset" feature to change the temperature equivalent of that cone. Subtract the same amount of degrees from the temperature equivalent that the kiln over-fired the cone by.

c) If the kiln shut itself off before bending the cones properly, you want to reprogram it and then re-start it as quickly as possible. Note the temperature at which the kiln shut down. Get from **CPLt** to **IdLE**, **tC2**, current temperature by pressing either **START/STOP** or **ENTER**. Re-program the same program to one cone number higher, then re-start the firing. Do these steps quickly. Now watch the middle cones again and note at what temperature the cones properly bend. If they bent while you were programming then just offset the temperature by 5 or 6 degrees. Shut the kiln off once you note that temperature. Using the "cone offset" feature, add

the difference of the two readings to that cone's temperature equivalent.

Note: From the factory, the settings that interpret temperature signals in the DynaTrol are hard-programmed; they will not change unless part of the microprocessor has been affected. There is a range of acceptability for the accuracy however and the cone offset feature exists to allow you to fine tune the kiln to particular sized loads. It is best to use all new thermocouples to properly tune the cone offset before individual thermocouples begin to drift. Even keeping one new thermocouple solely for calibrating the individual thermocouples will help to keep the kiln accurate.

CALIBRATING YOUR DYNATROL

This is also covered in the instruction sheet called **dynatrol-basic-operation.pdf** in the OPERATION section of your manual or at hotkilns.com/calibrating-kiln.

HELPFUL VIDEOS & LINKS

Calibration

More information on calibrating your kiln:
hotkilns.com/calibrating-kiln

Cone Offset

How to change cone offset in a DynaTrol:
hotkilns.com/change-cone-offset

How to change the thermocouple offset on a DynaTrol. This helps you calibrate the control to match your kiln:
hotkilns.com/change-thermocouple-offset

Firing with Witness Cones

This video shows you how to use witness cones to check the accuracy of the control and your kiln in an L&L Easy-Fire kiln. This video applies to any kiln:
hotkilns.com/firing-kiln-witness-cones

Orton Ceramic Institute

See ortonceramics.com for lots of very helpful information on how to use cones and for many firing tips and great information on firing kilns.

Cone Chart

You can see a "cone to temperature" chart in the LOG, CONES, TIPS, CERAMIC PROCESS section of your manual or at hotkilns.com/orton-cone-chart.

WHAT CONE NUMBERS MEAN: WHY YOU SHOULD CARE

The pyrometric cones used today by ceramic artists and industrial manufacturers were developed in the late 1800's by Edward Orton Jr. Dr. Orton recognized that ceramists needed a way to determine when their ware was fired correctly to develop the properties they required in their finished products. Thus all ceramic products were assigned a cone number to which they were to be fired to assure maturity of the ware during the firing process such as Cone 06 glazes, Cone 04 bodies, etc. Later, the development of electronic temperature controllers simplified the control of the firing process, but they could not replace the cones as a measure of the accumulative effect of time and temperature on the ceramic ware.

An interesting parallel to this principle would be the cooking of a turkey in your electric oven. You can set the oven temperature to 350 degrees Fahrenheit and place the turkey in the oven and estimate how long to cook it to attain an internal temperature of 180 degrees Fahrenheit. However if you want to be assured the turkey reaches the desired internal temperature you can place a meat thermometer into the turkey and it will tell when you have reached the desired internal temperature. Changing the oven temperature will surely effect the time required to reach the desired internal temperature. Cones serve a similar purpose in the firing of ceramics.

Both the Orton and the Bartlett electronic temperature controllers' cone-fire programs were developed based on the actual firing behavior of Orton cones and would not work without the information on cone behavior provided by the Orton Ceramic Foundation. These controllers automatically adjust the final firing temperature based on the actual heating rate of the kiln so that the kiln delivers the correct amount of heat work specified by the cone number program selected. Therefore the most efficient and reliable way to fire your kiln is to utilize the cone-fire programs built into your controller.

However, the electronic controller is not the ultimate answer for assurance that your ware has been fired correctly. The electronic controller measures the temperature inside the kiln via the thermocouple that is usually mounted in the side wall of the kiln and extending into the kiln 1 to 1½ inches. The thermocouple is great for measurement of temperature at a point in space and a point in time and provides the controller feedback needed to control the firing cycle. But heat work is a function of both temperature and time as measured by the bending of pyrometric cones.

Why is it so important to know if you have attained the correct cone firing? Look at the label on your glaze jar. The

odds are that the glaze is specified as a "Cone X" glaze. The unstated instruction for firing such a glaze is to "apply heat work equal to the cone number specified and the glaze will be properly matured". The glaze manufacturer has developed the glaze formula to mature at a certain cone number. The glaze manufacturer has conducted sufficient testing to know the fired characteristics of the mature glaze as related to glaze fit to the body, color development, the chemical resistance of the glaze surface, food-safe, etc. Under-firing or over-firing can prevent the glaze from attaining the appearance and properties you expect.

Since the thermocouple and the controller do not measure heat work how do you know if you actually matured the glaze in every firing? The thermocouple measures the temperature near the wall of the kiln where the heating elements are located and unfortunately has no means of measuring the temperature within the setting of the ware in the kiln and therefore cannot confirm if the distribution of heat work was uniform throughout the kiln. Remember the turkey story? One could fire the kiln with such a long firing cycle that all areas within the kiln received the desired amount of heat work, but this practice could require additional kilns to meet firing needs and the energy consumption would be wasteful. A definite overkill approach without merit. The programmable controller, coupled with the use of pyrometric cones, allows for the development of firing profiles to meet all your firing conditions. Since most shop operators want to have their kiln fully utilized during each firing, we will consider a fully loaded kiln of glazed ware to be fired to cone 06. The load placed in the kiln has a direct bearing on the firing profile required to successfully fire your ware. Select the cone-fire program consistent with the recommendation of the glaze manufacturer, in this case cone 06. Remember that selecting a cone-fire program alone does not insure that you will obtain uniform heat distribution throughout your ware. The controller is designed to compensate if the kiln is heating slower than the expected rate, but only at the tip of the thermocouple, it has no information about what is occurring in the interior of the ware setting. Place a series of three cones, 07, 06, 05 (self-supporting cones are the most convenient to use) one series located on the outside perimeter of the ware setting, and the second series located in the center of the ware setting on each shelf in the kiln (commonly referred to as "witness cones"). Fire the kiln. Once cool, remove the cones marking their location in the kiln. If the cone 06 is bent so that the tip is at the same level as the top of the foot of the cone in all locations, congratulations, you have just achieved a successful firing to cone 06. See Figure 1.

WHAT CONE NUMBERS MEAN: WHY YOU SHOULD CARE

Figure 1: Cone 07 is over-fired and cone 06 indicates a successful cone 06 firing.

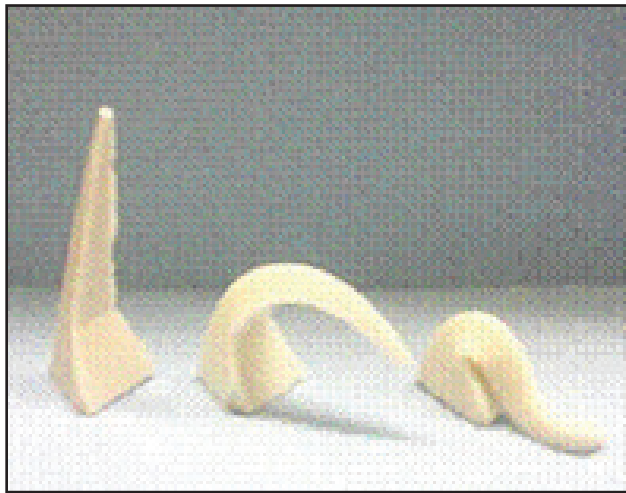

Cone 05 Cone 06 Cone 07

If some of the locations indicate that you did not reach cone 06, the tip of cone 06 is not bent enough, you will need to modify your firing cycle on your controller. By having cone 07 along side cone 06 you can determine by how much you failed to reach a cone 06 firing. Cone 07 measures a lesser amount of heat work than cone 06, therefore if cone 07 is bent so that the tip is at the same level as the top of the foot of the cone you are only one cone away from the desired heat work. See Figure 2. There are two simple ways to correct poor heat distribution within your kiln. First, for your cone-fire program if you selected either fast(#1) or standard(#2) heating speeds try slow(#3), which will allow more time during the firing cycle for the heat to equalize in the ware setting, or you can add additional hold time (soak) at the final cone temperature. A combination of both may be necessary depending on how heavily the kiln is loaded. Your kiln manufacturer or your controller manufacturer can be a good resource for suggestions to improve your firing program. The first question you will likely be asked is "what do your witness cones show". Repeat the procedure above once the change(s) to the firing cycle have been made.

Figure 2: Cone 06 has not reached the proper bending angle, indicating an under-fired condition.

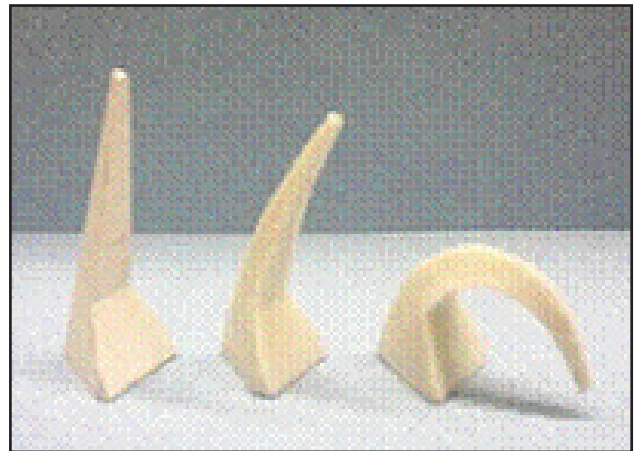

Cone 05 Cone 06 Cone 07

Since minor under-firing may not be obvious to the eye, the use of cones in every firing will alert you if there is a potential problem with the correct amount of heat work being delivered uniformly to your ware. And, when the cones confirm a successful firing, you can sleep a little better knowing you have taken a proactive, safe approach to providing your customers a high quality firing process. Retaining the cones constitutes physical proof that the ware was fired according to the glaze manufacturer's specification.

For more information on the use of pyrometric cones and the firing of ceramics please visit the Edward Orton Jr. Ceramic Foundation on the internet at www.Ortonceramic.com.

(Text written by the Edward Orton Jr. Ceramic Foundation, reformatd by L&L Kiln Mfg. Inc.)

VIDEO AVAILABLE

This video shows you how to use witness cones to check the accuracy of the control and your kiln in an L&L Easy-Fire kiln. This video applies to any kiln.

hotkilns.com/firing-kiln-witness-cones

The Ceramic Process **Firing Tips**

What happens when you fire clay

LOADING KILN WITH GREENWARE

When placing greenware in a kiln, all pieces may touch each other. To prevent possible distortion, place lids on the pieces they go with when firing to bisque. It is important to place the tallest pieces on the center of the shelf and work outward to the shortest pieces. This will give you the best heat circulation. Be sure the ware is totally dry before firing (unless you use a very long drying cycle). Moisture in the work can cause cracking or even an explosion. We suggest using either the SLOW BISQUE program for heavy loads with a Preheat time of between two to three hours or the FAST BISQUE program for lighter loads (again with a Preheat time of two to three hours). If you want to make up your own program, use the preset program as a guide (see Appendix F in the DynaTrol instructions, hotkilns.com/dynatrol-700, for a description of the segments in the preset programs). It is not a bad idea to Preheat the kiln overnight, as its only purpose is to thoroughly dry and start the expansion of the ware, so that the higher heat will not negatively affect it.

VENTING

If you are using the Vent-Sure automatic vent system, you can turn it on and leave it on during the entire firing. If you use an automatic vent, you do not normally need to prop the lid open or remove peephole plugs. If manually venting (without a powered vent), fire in the beginning with all the peepholes out. Then put bottom peephole plugs into peepholes after the low firing is over (you will know it is over when you start to see red heat through the peepholes). You typically want to leave the top peephole out during the entire firing if you do not have an automatic downdraft vent. NOTE: HEAVY GREENWARE MAY TAKE LONGER TO DRY. Be sure to use the Preheat feature in the DynaTrol for ensuring dry work. NOTE: If you have a lot of moisture in your work you may want to prop open the lid for the first hour of preheat even if you have an automatic vent system. (CAUTION: Propping open a lid in this way can cause the lid to crack if you are not careful).

LOADING KILN WITH GLAZE WARE

When placing ware into the kiln to be glaze-fired, we suggest placing the pieces ½" apart so that when they expand there is no danger of them touching each other. If pieces are placed too close together, they may touch and stick to each other, thereby ruining both pieces of ware.



Except for placing ware the proper distance from each other for good heat circulation, follow the instructions for the firing of greenware. Be certain that no piece while expanding can touch the thermocouples. Use either the FAST GLAZE or SLOW GLAZE program depending on your glaze needs (experiment if you are not sure), or make up your own program. Ask the supplier of your glaze if you use a commercial glaze. There are some good firing recipes in various glaze books such as **Mastering Cone 6 Glazes**. Your clay and glaze supplier will know the cone number to which you should fire your work.

OVERGLAZE FIRING

When firing overglazes such as Gold, Palladium, Mother of Pearl, China Paints, etc., the kiln must be vented during the firing up to 1,100°F. If you are manually venting, leave the peepholes open. (NOTE: This is if you are not using a vent system such as an L&L Vent-Sure which automates the venting process). Check with your clay and glaze supplier for recommended cycles.

SPEED OF FIRING

Although the kiln may be capable of firing relatively fast, this does not mean you should fire it as fast as it is capable of firing. The speed of firing will depend on what you are trying to accomplish. Check with the glaze or clay manufacturer or supplier for a recommended firing cycle.



Robert Shenfeld's studio in Syracuse NY where he produces production quantities of hand-crafted tiles.



505 Sharptown Road • Swedesboro, NJ 08085
Phone: 856.294.0077 • Fax: 856.294.0070
sales@hotkilns.com • hotkilns.com

KILNS BUILT TO LAST

Bulletin No: CP-3-15

The Ceramic Process **Firing Tips**

SOAKING

Soaking is holding the kiln at any given temperature for a set amount of time. One purpose is to achieve uniform temperatures on the inside and outside of your pieces. Other benefits include the smoothing out of glazed surfaces to get rid of pin holes or craters in the glazed surface. During the bisque firing, people often hold at different temperatures to allow the clay body to out-gas more of its organic material. Holding is also useful at a low temperature like 150°F to 180°F to dry out pottery or kiln wash on shelves.

The downside to holding only happens at high temperatures. There is almost no downside to holding at low temperatures except increased firing time and slight element and thermocouple degradation from the extra firing time. At high temperatures the amount of degradation to the elements and thermocouples is exponentially greater. As a result, holding the kiln at a high temperature will affect the element and thermocouple life.

Try soak times in the range of 5 or 10 minutes at the most. If longer, exercise care as the kiln may over-fire your work. Compensate by reducing the cone's temperature in the cone offset setting, or raise the thermocouple offset. Use witness cones that you can see through your peephole (and be sure to use dark safety glasses when doing so). If you see the cones bending (which would indicate proper heat-work achieved), then you can always turn off the control at that point manually. The Orton website has a great program available for free which helps you calculate how different temperature ramps and hold times will affect the "heat-work" and cone bending in a kiln.

FIRING LOG

Keep a firing log. Keep track of firing times, approximate load weight, firing temperatures and notes on results of the firing. There is a sample log in our instruction manuals (hotkilns.com/firing-log).

APPLYING KILN WASH

Kiln wash the floor of the kiln and the upper sides of the shelves only. Apply the kiln wash to the thickness of a postcard. The purpose of kiln wash is to prevent any glaze that drips from ware from sticking to the floor or shelves. If dripping should occur, remove dripping and cover the

spot with new kiln wash. Kiln wash is a powder mixed with water to a light creamy consistency.

For best results, apply three separate coats. If you brush one coat on, let it dry and then brush on another; you can brush off the first in the process, so ideally each coat should be fired on. The shelf can be used while firing the kiln wash, so theoretically you would put one coat on, load the shelves and do your test-firing of the kiln. The second coat would be fired on in the first bisque and the third coat in the second bisque or first glaze (whichever comes next). Fire at least to cone 018 — hot enough to give the kiln wash enough adherence to the shelf to prevent it from coming off in the second coating. Note that some people make do without three firings of the kiln wash. However, we include this recommendation as a "best practice".

WHAT HAPPENS WHEN YOU BISQUE AND GLAZE IN YOUR KILN

When you fire a kiln, you chemically and physically alter clay and glaze compounds in a way that, to some degree, can be anticipated and accounted for. There is quite a bit more going on during firing than meets the eye. It is useful to divide the processing cycle into separate distinct stages or segments. The stages that clay and glaze go through in a typical firing can be divided as follows:



COMPLETE DRYING

Even after you room-dry your work there will be some moisture left in the seemingly dry ware. Your ware will pick up moisture from the air, even if it is left for weeks on a warm, dry shelf. Bisque ware can also absorb moisture during glazing, and the newly applied glaze is really a very fine-grained clay coating at this point; it will retain the water it was mixed with and the water in the air until it is completely dry.

When you put this piece in the kiln it will first go through a complete drying stage. This is where any water that was in your ware evaporates and expands to 1,170 times its original volume. This moisture must escape from your ware before the kiln temperature gets to 212°F. It is important that the kiln temperature climb very slowly at first, and that the lid be propped 1" with several soft pieces of firebrick or ceramic posts and the peepholes opened if there is no forced venting system. (CAUTION: Keep in mind that propping open a lid in this way can cause the lid to crack if you are not careful). If you have a lot of moisture in your work you may want to prop open the lid for the first hour of preheat even if you have an automatic vent system. The amount of drying needed depends on factors such as how much mass is in the kiln and how wet the ware is. Factors that lead to a longer drying time include fine-grained clay and thick-walled ware. Be sure to use the Preheat feature in the DynaTrol which automatically sets the kiln temperature at the right drying temperature. Preheating overnight is recommended. It is best to be conservative to prevent the ware from exploding in the kiln. After a while you will get a feel for how long is necessary. Remember to carefully vacuum out your kiln if a piece that is not fully dried explodes.

THE "CERAMIC CHANGE"

This happens to each crystal and mineral particle in the clay body. Even though water between the crystals and minerals has already evaporated (hopefully during the slow preheat time), there is still water in these crystals and minerals that is venting off. This can occur all the way until the kiln reaches red heat. Slow firing is not as critical as there are pathways for the steam to travel through where the water molecules between the particles used to be. Venting, however, is critical to remove the water vapor.

The Ceramic Process **Firing Tips**

QUARTZ INVERSION

This is a generic name for the 20 or so changes quartz goes through as the temperature increases and the molecules/particles/atoms become increasingly mobile. Most phases that a particle of quartz goes through as the kiln is heating will reverse during cooling. One of the largest and quickest changes the quartz goes through is roughly at 1,060°F with about a 2% increase in the size of the particles during heating. The process is reversed during cooling. Also, during cooling another 2% contraction takes place at about 439°F. This is caused by the formation of “crystalite” in some clay bodies. There is a lot of other material in your clay besides quartz, so it is not always that important to account for the quartz while the kiln is heating up. The structure of unfired clay is full of pores and non-glass bound particles, so it can withstand the expansion of a few of its quartz particles. Once the clay is fired, though, the particles become part of a solid mass of glass. This mass is extremely intolerant of the expanding quartz particles. This is especially true in the glaze firing (even more so if the bisque was even slightly under-fired). In under-fired ware the quartz never has a chance to react with the fluxes and remains intact during a second firing, ready to expand and contract as your kiln heats and cools. This is one cause of dunting (fine cooling cracks). The glass mass simply has no room for the expanding quartz crystals.

BURNOUT

This is the burning off of any trapped organic matter in the clay. Burnout generally takes place at and above red heat. Sufficient airflow and time are necessary to burn off all the organic matter. If a bisque piece is under-fired, or fired too quickly, any unburned organic matter will bubble up through the glaze during the second firing. Even if the bisque is properly fired, there will still be some organic matter in the clay that will burn out once you pass the bisque's firing temperature. A glaze that fluxes too early will block off the exits for the gasses in the clay body and cause bloating or pitting.

SINTERING

This is the point at which powdered clay particles will begin to form chemical bonds with each other. Although the clay is not melting yet, it is forming a lump from the powdered clay. The point at which this begins to happen is called the ‘sintering point’. This, like burnout, happens right around red heat.

DECOMPOSITION

This is where fluxes really start to react and clay and glaze ingredients are deconstructed into their basic building blocks. This process can emit gasses such as sulfur and carbon dioxide which must travel out of the clay body. Once the firing is finished and the kiln cools, reconstruction takes place and the glaze and clay body recombine into a glass.

VITRIFICATION

This is a process that develops in the clay body during firing. At one point a piece of clay might be under-fired and at a higher point it may have good strength, but not good color; at another point it may be perfect and at another, even hotter point, the piece may warp, or melt. What is important to understand is that as the firing progresses, more and more activity is taking place on a molecular level. This is good only to a certain point, after which you are left with a warped blob, or puddle. You want to achieve the “glassification” of the clay. This occurs right before the clay body begins to slump. At this point the molecular bond between fluxes, quartz, silica and other materials makes the “glass”. However, it is the formation of the long mullite crystals (which only occurs above 2,000°F) from the decomposing clay crystals that gives the ware its strength.

GLAZE SET, COOL & FREEZE

Unlike the clay body, the glaze melts completely, and the bond between it and the clay becomes more complete as the temperature rises; eventually, the glaze starts to run. Things like fluidity and surface tension are determined first by the chemistry of the glaze, then by the layer formed by the heightened interaction between the glaze and clay molecules. When the ingredients of the clay and glaze have been properly matched, the nature of the molten layer between the two is such that when the kiln is at maximum temperature during firing, things like pinholes and bubbles can rise through this layer and reach the surface from the clay body within, and not remain trapped in the surface when the glaze sets and begins to cool. Once maximum temperature is reached and the kiln begins to cool, the glaze and clay body will follow. The glaze will not solidify until some time after the kiln begins to cool. When this happens depends on the rate of cooling and the chemistry of the glaze. Right before the glaze solidifies, however, crystals can form. Depending on its chemistry, the glaze can solidify quickly and form crystals. Or,



Bill Campbell at work.

“I make a living out of my five L&L kilns. I really beat them up firing them at least three times a week to Cone ten. They take a real beating and keep on going” -Bill Campbell

with some glazes, crystal formation can take place throughout the initial cooling until the glaze finally solidifies several hundred degrees lower than the highest temperature. By adjusting the glaze recipe slightly, one can maximize or minimize the forming of crystals in the glaze during cooling. Once the glaze solidifies it is still important for the kiln to cool slowly. Crazing (fine cracking) can occur if cooling is too rapid. Heat shock, which is usually catastrophic, is something that can happen in the kiln or may occur gradually over time.

In truth, simply test-firing the kiln and the ware to be fired is usually enough to deal with the complexity of the process. Every kiln and kiln-load fires differently, and a new kiln is no exception. The use of a vent system is recommended simply because it will exhaust any detrimental particles and fumes from the kiln, circulate air in the kiln and provide an oxygen-rich atmosphere. See ortonceramics.com for helpful information on how to use cones, firing tips and great information on firing kilns. They have an excellent program available for free which helps you calculate how different temperature ramps and hold times will affect the “heat-work” and cone bending in a kiln.



Firing Glass in a Ceramic Kiln

How to use an L&L Ceramic Kiln with a DynaTrol to Fire Glass

BASIC IDEAS

Glass is not as forgiving as clay when fired in a kiln. Temperatures and firing times must be more precise; as such firing glass requires special considerations when fusing and slumping in a pottery kiln.

Using a kiln sitter with cones is a difficult process when fusing and slumping glass and will not be discussed here. The following instructions address how to use a DynaTrol digital controlled pottery kiln when fusing and slumping glass. Glass casting is a special process and is not covered by the following information.

Pottery kilns heat from the side elements where as glass kilns heat from the lid element and side element. In most glass kilns the lid element provides 70% of the heat and the side elements provide 30% of the heat. The lid element throws heat down in a uniform manner across the kiln shelf. The side element is only there to adjust for the height of the kiln.

A pottery kiln heats from the sides toward the center. Using a standard glass firing sequence in a pottery kiln will cause the glass pieces on the outer edges of the kiln shelf to fuse long before the glass pieces in the center of the kiln shelf. If firing a large piece of glass the outer edges will fuse quickly and trap air bubbles in the glass and by the time the center of the piece reaches fusing temperature the outer edges will be over fired and may become distorted and thin.

The number of stacked shelves (amount of furniture) will impact the firing of the kiln. Kiln furniture absorbs heat before the glass absorbs heat causing what is referred to a heat steal. Also impacting glass firing in a pottery kiln is the size of the kiln plus if the kiln is made of 3 inch brick will also affect the firing. Glass kilns tend to be shorter in height than potter kilns and are usually made of 2 ½ inch brick or refractory fiber board or blanket.

With side elements, kiln furniture, size of the kiln and brick thickness you must fire slow in a pottery kiln when firing glass. If you fire too fast you will have an over fire plus you may also thermoshock the glass causing it to break. If you cool too fast you

will thermoshock the glass causing it to break.

The following fusing sequences are to be used as a starting point from which you will develop your own firing sequence for successful firing of your projects. The sized of your kiln and how you load the furniture may require refining the sequence below.

You would use the same firing sequence for small jewelry pieces as well as large platters and bowls.



On the left of the DynaTrol digital controller is a yellow section labeled "VARY-FIRE". This feature has 6 user programs each user program has 8 segments. A segment permits the artist to input firing sequences with a specified ramp rate in degrees per hour, a soak temperature, and a soak time. These three items comprise a segment. You select the number of segments needed for your firing sequence.

Simple firings like jewelry and small plates and bowls you should be able to obtain good results with the use of 2 segments.

If you are loading the kiln with multiple shelf levels or a single shelf you would use the 3 zone feature of your kiln to obtain uniform heating.

The assumption is made that you already know how to safely and correctly operate your DynaTrol digital controlled kiln. The following information is provides a guide line for adjusting your firing from pottery to glass.

The following information is not to replace the instructions provided in your kiln owner's manual. Refer to the owner's

manual for complete information on the operation and features of the DynaTrol digital controller.

After loading your kiln you would set the DynaTrol digital controller in the following manner.

NOTE: All degrees listed below are degrees F. If you want to use degrees C you will need to set the controller for degrees C and convert the degrees F below to degrees C for you firing.

The firing schedule below is for use with Bullseye, Uroboros, or Spectrum Glass. It is not for use with float or borosilicate glass.

FUSING GLASS

1. If the kiln has an off/on switch, turn the kiln on.
2. The kiln should indicate it is in the idle mode by flashing "Idle", the number of zones and the temperature inside the kiln.
3. Press the "Enter Prog" key in the VARY-FIRE section. You will see the display flashing between "USER" and a number between 1 and 6. At this point you want to choose which USER program you want to use. You can set USER 1 for a fusing project and you can set USER 2 for a slumping project, as an example.
4. Press the number 1 on the key pad, then press the ENTER button in the number key pad area. You have chosen to use "USER 1"
5. The display will now flash SEGS and a number. It is asking how many segments you want to use for your firing.
6. Press the number 2 on the key pad, then press the ENTER button in the number key pad area. You have chosen to use 2 segments for your firing.
7. The display will now flash RA 1 and a number. It is asking for the ramp rate in degrees per hour for the first segment.
8. Pressing the number keys enter 150, then press the ENTER button in the number key pad area. You have instructed the controller to heat at 150 degrees per hour. This means that after 1 hour the kiln will be at room temperature plus 150

Firing Glass in a Ceramic Kiln

degrees, after 2 hours it will be at room temperature plus 300 degrees, and so forth.

9. The display will now flash °F 1 and a number. It is asking for the soak temperature for the first segment.

10. Pressing the number keys enter 1450, then press the ENTER button in the number key pad area. You have instructed the controller to heat to 1450 °F. This means that the kiln will heat at a rate of 150 degrees per hour and go to 1450 degrees, taking roughly 9.66 hours to do so.

11. The display will now flash HLd 1 and a number with a decimal point 2 digits to the left, You may have a number which looks like 12.30 or 1.20 or 0.20. The decimal point separates minutes from hours. Hours to the left of the decimal point and minutes to the right of the decimal point. It is asking for the soak time period for the first segment.

12 - Pressing the number keys enter 15, then press the ENTER button in the number key pad area. You have instructed the controller to soak for 15 minutes. On review of the program you would see: 0.15. You have entered the first segment.

13. The display will now flash RA 2 and a number. It is asking for the ramp rate in degrees per hour for the second segment.

14. Pressing the number keys enter 150, then press the ENTER button in the number key pad area. You have instructed the controller to cool at 150 degrees per hour.

15. The display will now flash °F 2 and a number. It is asking for the soak temperature for the second segment.

16. Pressing the number keys enter 100, then press the ENTER button in the number key pad area. You have instructed the controller to cool to 100 °F. This means that the kiln will cool at a rate no faster than 150 degrees per hour and go to 100 degrees, taking roughly 14.5 hours to do so.

17. The display will now flash HLd 2 and a number with a decimal point 2 digits to the left, You may have a number which looks like 12.30 or 1.20 or 0.20. The decimal point separates minutes from hours. Hours to the left of the decimal point and minutes to the right of the decimal point. It is asking for the soak time period for the second segment.

18. Pressing the number keys enter 30, then press the ENTER button in the number key pad area. You have instructed the controller to soak for 30 minutes. On review of the program you would see: 0.30

19. The display will now flash ALRM and 9999. It is asking if you want to have an alarm sound when the kiln reaches a particular temperature. The number 9999 instructs the controller NOT to sound any alarm.

20. Press the ENTER button in the number key pad area, with the 9999 number in the display, if you do NOT want an alarm. If you want the controller to sound an alarm notifying you that it has reached a particular temperature enter that temperature number on the key pad and then press the ENTER button in the number key pad area.

21. The display will now display CPL for a few seconds then switch to the IdLE mode. You have entered the second and final segment. The digital controller has the above firing sequence in its memory as USER 1. It will remember this firing sequence even after the kiln is turned off. You can edit and change the firing sequence any time.

22. When the display is in the IdLE mode press the "Recall Prog" button in the VARY FIRE section of the key pad. The display will flash USER and a number. Press the number 1 and then press the "START /STOP" button. The display will briefly show STOP then switch to the IdLE mode. Press the START/STOP button again. The display will show -- ON -- and the controller will start the firing the USER 1 program.

Note: The digital controller does not understand heating or cooling. It only understands what temperature it is at and what temperature it is to go to. Thus it will adjust the firing to go to the destination temperature.

The above glass firing sequence has instructed the kiln to do the following.

Heat at 150 degrees per hour, go to 1450 degrees, stay at that temperature for 15 minutes then cool at 150 degrees per hour, go to 100 degrees and stay at that temperature for 30 minutes then stop firing.

SLUMPING GLASS

To slump glass you will use the same sequence however you must change the

soak temperature from 1450 degrees to 1250 degrees, all other values remain the same.

HOW TO CORRECT FOR OVER OR UNDER FIRING WITH THE ABOVE FIRING SEQUENCE

Only change one variable at a time.

1. I suggest that you adjust the soak time not the temperature.
2. If the glass is over fired reduce the soak time by 5 minutes.
3. If the glass is under fired add 5 minutes to the soak time



ANNEALING GLASS

The above firing sequence passes through the annealing temperature so slowly that the glass is annealed. If you want to use a formal annealing cycle you would use 3 segments with the second segment having the annealing soak temperature and soak time in it. The heating and cooling rate would remain the same.

Marty Dailey - Sept 2006

Firing Tips

LOADING A KILN FOR BEST RESULTS

Loading a kiln for firing is not a simple matter of placing shelves and stacking ware. The more thought and planning that is put into loading, the better the results. Ware and shelf placement, the size of the load, the firing characteristics of the kiln and the type of ware being firing are all important factors.

First the Furniture

Kiln shelves come in all shapes and sizes. For economy of space, it is best to choose shelves similar in shape and size to your kiln chamber. For instance, use a round or multi-sided shelf in a round or multi-sided kiln. Keep the size small enough so there is at least 1" of space between the shelf edge and the side of the kiln or the Kiln-Sitter®. Also allow some room between the top of your ware and the lid of the kiln and leave space for witness cones amongst your ware.

Select posts in heights to accommodate the ware you are firing. Leave some room between the kiln shelves for air to flow, for heat transfer and for removal of fumes.

Half shelves are very useful to improve

air movement in the kiln. Use two side by side with a 1/2" space between them and you don't lose much stacking space.

Some kiln manufacturers recommend placing shelves directly on the floor of the kiln. Most suggest using 1" posts to put the bottom up from the cooler floor. This creates an insulating layer much like a storm door.

Setters and Stilts

Air movement in the kiln is clearly a big consideration - one of the most important when loading a kiln. Ceramics need to heat uniformly to prevent warping and stresses in the ware. Air needs to move around shelves and around individual pieces.

Plates and tiles benefit from the use of tile and plate setters or stackers. Shelf-style setters allow air to move under the large flat objects so they heat more evenly. Avoid heating large flat objects directly on the cooler shelf. If you are firing decorated tiles or plates, vertical setters economize on space, and sets can be stacked to fit even more.

 **Orton**

The Edward Orton Jr.
Ceramic Foundation

PO Box 2760 • Westerville OH 43086

FIRING TIPS is a series of firing problem solvers. New TIPS are available every month. Contact your Orton supplier for your copy.

Glazed ware needs to be stilted or dry footed or the melting glaze will stick the ware to the kiln shelf, ruining both. Stilts also provide space for air to move around all sides of the ware. Porcelain and stoneware can not be stilted. The stilts embed into the ware during firing. Instead, use high fire kiln wash or silica sand on the shelf. Use prop to prevent sagging of porcelain.

Consider Heat Distribution

It is important to evaluate heat flow in your kiln and to make this a consideration in loading. Use pyrometric cones to determine the heating characteristics of your kiln so you know where the hot and cooler places are. Arrange your ware with different sized pieces on the same shelf to allow better heat flow.

Don't Overfill

Perhaps one of the most important factors in good fired results is enough air to mature the ware - to burn out organics in bisque and develop best colors in glazes. Shelf and ware placement and the use of setters and stilts can all help this, but here are a couple more tips:

1. When stacking bisque, invert bowls and mugs opening to opening instead of nesting - this helps air move around all sides of a piece and prevents black rings and spots in the bottom of ware.
2. Fire bisque lids and bottoms together. To get the best fit for lids, fire them on the piece they match.

This will let the two pieces shrink together so you get a good tight fit. Fire all glaze pieces separately.

3. Leave space between ware - don't overfill. There is a temptation to cram as much as possible into the kiln to economize on firing costs. Ware fired too closely together creates firing problems. If you must overfill, fire very slowly and vent adequately.
4. Mix thin and thick-walled pieces together throughout the load - don't concentrate them in one area where they are competing for air and heat.
5. Use downdraft venting to move air through the kiln and to remove fumes created during firing.

Want to learn more?

Read more about Loading A Kiln in the Orton Firing Line and Technical Tips publications. Each issue is packed full of articles to help you learn more about firing. Members of the Orton Firing Institute receive these publications at no charge. Single copies are available to non-members at a per issue rate. Orton's 80 minute video, *Key Principles of Successful Firing*, is also an excellent resource on firing.

For information on Orton products, see your Orton dealer or distributor. For information on the Firing Institute or publications, contact

Orton Firing Institute, PO Box 2760,
Westerville OH 43086, 614-895-2663.

**Orton pyrometric cones and bars • KilnVent systems
kiln accessories and firing supplies • Orton Firing Institute**

Firing Tips

UNDERSTANDING HEAT TRANSFER

How Heat is Transferred

Heat moves through the kiln from hotter to cooler zones by:

1. convection
2. conduction
3. radiation

Convection

Convection is the first step in the heating process in the kiln. Air is heated as it passes across the warming kiln elements. As the hot air rises and cool air falls, air currents are created which circulate hot air to cooler places in kiln. This heat is transferred to the ware, shelves, etc.

The kiln will not be uniform in temperature at this early stage of firing unless the hot air is pushed through the kiln by mechanical means. Low cone firings such as 022 and 021 depend more heavily on convection for heat transfer.

The most common type of convection we are familiar with is wind chill. The cool air passes across the face and pulls heat from our warmer body, which lowers our skin temperature.

Conduction

When heat moves through a solid, it is conducted. An example would be heat moving through the handle of a saucepan. This is a slow way to heat, but the handle will eventually get hot.

In a kiln, conduction moves heat from the inside to the outside of the kiln and from the outside to the inside of the ware. Conduction is the main way we get uniform heating in the kiln. This is a slow process and if we fire too fast, the inside of our ware will receive too little heat and not fire properly.

Radiation

At the beginning of the firing, the elements are the hottest part of the kiln. The heat from the elements radiates out - like the sun warming us on a cool day. Eventually the firebrick and the ware will also get hot and will radiate heat as well.

As the temperature increases, more and more of the heat is transferred by radiation from the heating elements. For uniform heating, is important that all surfaces of the ware be exposed to heating elements, even partially.

Orton

The Edward Orton Jr.
Ceramic Foundation
PO Box 2760 • Westerville OH 43086

FIRING TIPS is a series of firing problem solvers. New TIPS are available every month. Contact your Orton supplier for your copy.

4. Time and temperature profile during the burn out period

Both time and temperature are important for proper burn out of the carbon. Some carbons require much higher temperatures than others. Oxidation should be completed below red heat (1400°F).

Carbon burns out from the surface first. As more oxygen penetrates the body, then more carbon is reacted to form the CO or CO₂ gas and the burn out process continues. If there is sufficient time, temperature and oxygen, then complete burn out occurs. If these conditions do not exist, the resulting incomplete burn out is referred to as black coring (where the center of the piece has a black or gray cast).

Incomplete Burn Out

Incomplete burn out can result in several firing problems including:

1. Bloating of the ware
If the temperature is hot enough, the outside of the piece will seal up before all the gases can escape. As the body becomes plastic due to glass forming, gases trapped inside the body expand with heat and cause bloating and sometimes cracking of the ware.
2. Glaze defects, such as pinholes
The escaping gases will push through the glaze surface and cause bubbles which pop. If these do not heal, then pinholes will result.
3. Appearance of fired bisque

Where carbon burn out is incomplete, the piece will have a grayish cast (white bodies) or may have a greenish cast (red bodies). The body will also be more porous and weak.

Preventing Incomplete Burnout

1. Slow down the firing.
2. Be sure the kiln is vented adequately so there is sufficient oxygen.
3. Load the kiln with burn out requirements in mind.

Leave plenty of space between ware and shelves. Do not stack ware. Use tile and plate stackers and invert pieces on top of one another to help conserve space and insure proper burnout.

Want to learn more?

Read more about carbon related glaze and body defects in the Orton Firing Line and Technical Tips publications. Each issue is packed full of articles to help you learn more about firing. Members of the Orton Firing Institute receive these publications at no charge. Single copies are available to non-members at a per issue rate. Orton's 80 minute video, *Key Principles of Successful Firing*, is also an excellent resource on firing.

For information on Orton products, see your Orton dealer or distributor. For information on the Firing Institute or publications, contact

Orton Firing Institute, PO Box 460,
Westerville OH 43086, 614-895-2663.

**Orton pyrometric cones and bars • KilnVent systems
kiln accessories and firing supplies • Orton Firing Institute**

Firing Tips

CRACKING AND THERMAL SHOCK

Cracks that appear in fired ware which were not caused by casting or drying problems may be the result of thermal shock.

Thermal shock occurs when too much stress is created in a piece of ware during the heating and cooling process. It comes from temperature differences in the ware and can cause small to large cracks in the piece, or the piece may actually break.

Why Does Cracking Occur?

The tendency of a piece of be susceptible to thermal shock is related to:

- the strength of the piece
- the thermal expansion of the material

Thermal shock can result when changes in temperature occur in the kiln during heating and cooling. As temperature changes rapidly, the outside of the ware and kiln furniture becomes much hotter or cooler than the inside. This causes stresses which may result in cracking or breaking.

The following can effect thermal shock

- a fast heating rate or rapid cooling
- a sudden influx of cool air such as opening the kiln lid when the kiln has not finished cooling
- in a gas kiln - turning off the gas and allowing cool air from the burners to enter the kiln

Thermal shock can also occur when ware is stressed in use such as a casserole or dish that is taken from the freezer or refrigerator and put into a hot oven.

The stronger ware is, the better able it is to resist cracks due to thermal shocking. Weak ware will be more likely to break when stressed.

A piece that is porous will also be weaker, making it easier to crack. Water or condensation that enters pores in the ware can turn into steam and expand and this can cause cracking when heated. The harder (hotter) ware is fired, the less porous it will be.

Ware that expands and shrinks a great deal during heating and cooling is also more likely to be affected by thermal shock. Most kiln shelves contain

**Orton**

The Edward Orton Jr.
Ceramic Foundation
PO Box 2760 • Westerville OH 43086

FIRING TIPS is a series of firing problem solvers. New TIPS are available every month. Contact your Orton supplier for your copy.

cordierite because this material has a lower expansion than most of our ware and so less affected by thermal shock.

What Happens to Ware During Firing?

During heating and cooling, the body and glaze undergo many physical and chemical changes. Some of these include:

- moisture is driven out of the ware - if this occurs too rapidly, cracking can occur
- organic material is oxidized and released from the material
- the glaze softens, melts and flows during heating and may trap gas
- the body expands as it is heated and contracts during cooling
- the glaze solidifies and contracts during cooling

If the body or glaze contains silica, it will expand rapidly at 1063°F on heating and contract during cooling. If the heating or cooling is rapid near this temperature, this change can lead to cracking of the piece.

Control of heating and cooling is especially critical when firing thick-walled pieces or pieces with an irregular wall thickness.

Reducing Thermal Shock

There are several easy ways to minimize the potential for thermal shock:

- use a smooth, moderate heating rate
- let the kiln cool naturally with the lid closed

- use a controller to slow down the cooling time
- avoid sudden temperature changes

A programmable controller such as the Orton AutoFire™ is the best solution to control the heating and cooling rates and to get a smooth temperature rise.

If instrumentation is not available, heat loss during cooling can be controlled to some extent by keeping the kiln closed until well below red heat (900°F).

To be sure that ware is properly matured, be sure to use witness cones. Underfired bisque will continue to shrink during the glaze firing and this can result in a poor glaze fit.

Want to learn more?

Read more about cracking and thermal shock in the Orton Firing Line and Technical Tips publications. Each issue is packed full of articles to help you learn more about firing. Members of the Orton Firing Institute receive these publications at no charge. Single copies are available to non-members at a per issue rate. Orton's 80 minute video, *Key Principles of Successful Firing*, is also an excellent resource on firing.

For information on Orton products, see your Orton dealer or distributor. For information on the Firing Institute or publications, contact

Orton Firing Institute, PO Box 2760, Westerville OH 43086, 614-895-2663.

**Orton pyrometric cones and bars • KilnVent systems
kiln accessories and firing supplies • Orton Firing Institute**

Firing Tips

CRACKING AND WARPING CAUSED BY DRYING AND CASTING

In some instances cracking and warping problems share a common source: the casting and drying of the piece. In other cases, cracking may be related to how the piece is fired. This Tip looks at problems related to casting and drying.

DRYING CERAMICS

Ceramics contain clay which can absorb and hold water. Before firing, it is important to remove all of the physical water so that the piece will not crack or explode when heated. This is often accomplished in steps with firing being the final stage. During firing, the chemical water is removed from the piece and it gains strength while developing physical surface characteristics.

UNDERSTANDING DRYING

Simplified, drying is the removal of water from body by evaporation. As the ware is dried, the film of water separating the clay particles gets thinner and thinner, the solid particles get closer together and the piece shrinks. Shrinkage stops when the particles finally contact each other.

DRYING FAULTS

Cracking, distorting and warping are problems that may not become evident until after firing. They are usually caused by drying too fast or unevenly.

If ware is heated too fast, the pressure from water vapor inside the piece can cause cracking. Ware dried only on one side, can shrink more on that side causing warping or bending of the somewhat plastic (flexible) piece. When one surface finishes drying, the piece is now too stiff to recover and the warping becomes permanent. This can lead to cracking.

Bodies made of very plastic clays or compositions having a high clay content require attention to uniform, slow drying.

Thicker walled pieces will often have a greater tendency to warp or distort.

Care needs to be taken to allow for uniform air movement around all sides of a piece to avoid drying problems. Sometimes drying must be slowed down to avoid cracking.

**Orton**

The Edward Orton Jr.
Ceramic Foundation
PO Box 2760 • Westerville OH 43086

FIRING TIPS is a series of firing problem solvers. New TIPS are available every month. Contact your Orton supplier for your copy.

Handles on cups can have a tendency to pull away from the mug. Doll heads and chest cavities may deform inward.

REDUCING WARPING AND CRACKING

To reduce warping and cracking, take steps to dry more slowly and more evenly from all sides.

Don't dry a flat object on a wet or cool surface like a formica or plastic table top or damp newspaper. The piece can only dry on one side. Instead, dry objects on something porous like wood or plaster or set them so air can circulate around them. If necessary, turn pieces over during drying for more even result.

Slow the drying of thick walled pieces and hand built ware.

Support areas during drying that might cause stresses to build up.

DRYING TECHNIQUES

slip cast ware - may warp or crack if stressed (deformed) when removed from the mold. Even if the ware is gently returned to the original shape, the created stress will ultimately cause the piece to warp or crack.

wheel thrown ware -should not distort during drying unless subjected to further mechanical forces - let the ware dry naturally on a bat or shelf and it should be fine.

thick handbuilt ware - needs to be

dried for a very long time before it can fired or it may explode during firing. Several days may be required or a low heat drying in an oven may be necessary to remove all the water.

plates - even drying is particularly important with plates. Warping can cause the center of plate to fall or arch up. Rims and centers must dry evenly to prevent warps, humps and cracks.

drying tiles - drying tiles can present a particular challenge because it can be difficult for the piece to dry evenly. Usually air is passed over the top of the tile. This results in warping because the bottom of the tile remains wet. Drying tiles in tile racks can help air movement for more even drying.

Want to learn more?

Read more about Solving Cracking and Warping Problems in the Orton Firing Line and Technical Tips publications. Each issue is packed full of articles to help you learn more about firing. Members of the Orton Firing Institute receive these publications at no charge. Single copies are available to non-members at a per issue rate. Orton's 80 minute video, *Key Principles of Successful Firing*, is also an excellent resource on firing.

For information on Orton products, see your Orton dealer or distributor. For information on the Firing Institute or publications, contact

Orton Firing Institute, PO Box 2760,
Westerville OH 43086, 614-895-2663.

**Orton pyrometric cones and bars • KilnVent systems
kiln accessories and firing supplies • Orton Firing Institute**

Firing Tips

USING THE THREE CONE SYSTEM

All ceramic products fire within a range to develop best fired properties. Some products such as stoneware have a wide firing range. Other products such as porcelain slip and leadless glazes have a narrow firing range (less than 2 cone numbers).

To be sure ware is properly fired, it is important to understand how your kiln is firing. The Three Cone System is an excellent way to do this.

What is the Three Cone System

The Three Cone System consists of three consecutively numbered cones:

Firing Cone - cone number recommended by manufacturer

Guide Cone - one cone number cooler

Guard Cone - one cone number hotter

For example: Cones 017 (guide cone), 018 (firing cone), 016 (guard cone)

Uses for the Three Cone System

- determine temperature uniformity in the kiln
- check the performance of the Kiln-Sitter® or electronic controller
- manually shut off the kiln by direct observation of the cones bending

- evaluate heatwork that ware receives during firing

How Witness Cones Work

Pyrometric cones indicate how much heat has been absorbed. Witness cones set on the shelf near the ware are true indicators of whether the ware received the proper amount of heat. Products are expected to be fired to a cone number or within a range of numbers. For some products, good results can be obtained at a cone lower or higher. Other products have to be fired very precisely.

Using the Three Cone System for Manual Shut-off

By observing the witness cones during firing, the end of the firing can be determined for manual kiln shut off.

To use the Three Cone System for manual shut-off, place cones on a kiln shelf near the center of the load, but out of a draft and where they can be observed through the peephole

When the kiln is near its firing point, the Guide cone will begin to bend. The ware is approaching maturity and soon the kiln can be shut off.

 **Orton**

76

The Edward Orton Jr.
Ceramic Foundation
PO Box 460 • Westerville OH 43081

FIRING TIPS is a series of firing problem solvers. New TIPS are available every month. Contact your Orton supplier for your copy.

It takes about 15 to 20 minutes for the Firing Cone to reach it's end point. The cone bends slowly at first, and more quickly after the half way point. When the cone tip is even with the top of the cone base, it is time to shut off the kiln. If the Guard Cone bends, the desired heatwork has been exceeded.

Using the Three Cone system to Evaluating Kiln Performance

Most kilns have temperature differences from top to bottom. The amount of difference depends on

- design of the kiln
- age of the heating elements
- load distribution in the kiln
- cone number being used

Usually, there will be a greater temperature difference at lower cone numbers than at higher ones. Placing a set of cones on each shelf during various firings allows you to determine the heating uniformity of your kiln for the materials you fire.

After firing, observe the cones and evaluate the heat distribution in the kiln. If only the guide cone is bent, there is less heat on that shelf. If the guard cone is bent, there is more heat on that shelf.

If you do find a difference, the heating uniformity can be improved by changing the kiln loading, adjusting switching or adding a downdraft vent system.

Checking Kiln-Sitter® Performance

The Kiln-Sitter® is designed to shut off the kiln as a Small Cone or Bar deforms. Here's how it works:

- Small Cone/Bar is placed under sensing rod
- firing begins, cone/bar receives heat, begins to soften
- sensing rod presses down, cone bends with weight
- movement of rod activates shut-off

Because the cone or bar in the Kiln-Sitter® is near the kiln wall (closer to the heating elements), it may receive more heat than witness cones on the shelf. If the kiln shuts off before the witness cones have properly deformed, you may need to use the next hotter cone number in the Sitter®.

Witness Cones Are Like Insurance

Cones are considered an inexpensive way to monitor your kiln and detect problems before a crisis occurs. Use Self-Supporting Cones for the Three Cone System because they are the easiest to use and most consistent cones available.

Want to learn more?

Read more about The Three Cone System in the Orton Firing Line and Technical Tips publications. Published 8 times a year, each issue is packed full of articles to help you learn more about firing. Members of the Orton Firing Institute receive these publications at no charge. Single copies are available to non-members at a per issue rate.

For information on Orton products, see your Orton dealer or distributor. For information on the Firing Institute or publications, contact

Orton Firing Institute, PO Box 460,
Westerville OH 43081, 614-895-2663.

**Orton pyrometric cones and bars • KilnVent systems
kiln accessories and firing supplies • Orton Firing Institute**

Firing Tips

CONES AND CONTROLLERS

Automatic controllers and shut-off devices are a convenient way to heat and turn off a kiln. But for consistent results it is still important to know how much heat the ware received. Only cones provide this information.

Witness cones set near the ware tell if the firing reached the cone value necessary to properly mature the ware. Cones also help in diagnosing firing problems.

Advantages of Controllers

Electronic controllers have many advantages. They:

- allow heating rate control - heat up/cool down of the kiln
- permit slow down of the firing below red heat to burn out carbon and organic materials
- permit elimination of a kiln shut-off device, although some use this as a safety backup
- allow soaking of kiln at the firing temperature to get more uniformity of fired pieces or for special results
- provide more consistency from firing to firing

So with all of these advantages, why

are cones still needed?

Firing Ceramics

Firing ceramics is much like baking food, except ceramics go to higher temperatures. When we bake, we leave food in the oven at a temperature for a certain time. A thermometer may help measure the temperature of our food or we may stick a fork in to test whether it seems right.

It is the same with firing - a combination of temperature and time "cooks" the ware. However, unlike baking we can't put our ware into a preheated kiln and poke a fork in our pot to test doneness. The next best thing is to place Pyrometric Cones near the ware to measure whether it has received enough heat.

Firing With Cones

The bodies, glazes and decoration products we use are all formulated to be correctly fired when they have received enough heat to properly bend a cone. The companies and individuals who make and test these supplies use Orton Cones. Cones deform when they have received the

Orton

The Edward Orton Jr.
Ceramic Foundation
PO Box 2760 • Westerville OH 43086

FIRING TIPS is a series of firing problem solvers. New TIPS are available every month. Contact your Orton supplier for your copy

right amount of heat, not just when the kiln reaches a certain temperature. In other words, cones behave just like your ware. This is why they are such good indicators of whether the ware was properly fired.

How Controllers Work

Electronic controllers regulate power to the heating elements. They do this by comparing the temperature measured by a thermocouple with the expected temperature programmed into the controller. If the temperature is low, heat is added.

Controllers fire a kiln to a temperature. If this temperature is not measured accurately, the controller will fire the kiln improperly. Most controllers use a Type K thermocouple, which is less expensive, or a platinum thermocouple (Type S), which costs more but is more accurate and has a longer life.

Measuring Temperature

Even brand new, a Type K thermocouple can vary from a true reading, as shown below. On the other hand, a Self-Supporting witness Cone will vary no more than 4°F.

Cone	Variation in New Thermocouples		Max. Cone Variation
	Type K	Type S	
020	8.5°F	2.9°F	4°F
06	13.5°F	4.5°F	4°F
6	16.6°F	5.6°F	4°F

This variation in the temperature measured by a thermocouple becomes even larger after the thermocouple has been used for awhile. It is not unusual for a Type K thermocouple to have an error of more than 25°F when fired to Cone 6 repeatedly. This means that more than a full cone error can be introduced.

Using Controllers and Cones

Controllers do a good job at what they do - controlling the heating and cooling rate and providing consistency from firing to firing. However, if witness cones are not used with the controller, there is no way of determining what the actual firing conditions were, except by how the ware looks. By then, it may be too late.

Want to learn more?

Read more about using cones and controlling a kiln in the Orton Firing Line and Technical Tips publications. Each issue is packed full of articles to help you learn more about firing. Members of the Orton Firing Institute receive these publications at no charge. Single copies are available to non-members at a per issue rate. Orton's 80 minute video, *Key Principles of Successful Firing*, is also an excellent resource on firing.

For information on Orton products, see your Orton dealer or distributor. For information on the Firing Institute, video or publications, contact

Orton Firing Institute, PO Box 2760, Westerville OH 43086, 614-895-2663

Orton pyrometric cones and bars • KilnVent systems
kiln accessories and firing supplies • Orton Firing Institute

Firing Tips

AVOIDING CARBON BURNOUT PROBLEMS

Materials used in ceramics contain naturally occurring impurities that can affect the color, appearance and maturing temperature of the product.

Carbon, found in most clays, is normally considered one of these impurities. Carbon can also be present in the additives and binders which make up clay bodies, slips, decals and lusters.

How Carbon Burns Out

During heating (firing) the carbon reacts with oxygen to form carbon dioxide and carbon monoxide gases. The carbon leaves the body as a gas.

Binders are burned off at a relative low temperature: 300°F to 500°F.

Naturally occurring carbon in clay burns off (become gases) at higher temperatures: up to 1200°F-1400°F.

The rate at which this carbon burns out is related to:

1. The amount of carbon present (that is, the amount of natural contaminants in the body)

Some bodies have more contaminants than others, such as red clays. This needs to be considered when planning the firing.

2. Amount of air available (air provides oxygen for burnout)
Air needs to get to the carbon inside the body.

This is impacted by several factors. A load that is fired very quickly will not allow enough time for the oxygen to react with the carbon, form gases and leave the ware.

If ware is stacked during bisque firing, oxygen may not be able to penetrate all surfaces of or inside all the pieces.

Also, if gases are not removed from the kiln and replaced with fresh air, then there may not be sufficient oxygen to burn out the carbon.

3. Thickness of the piece

Air has to penetrate through the entire thickness of the piece and the gases have to escape the same way. It takes longer for carbon to burn out of a thicker piece of ware.



The Edward Orton Jr.
Ceramic Foundation
PO Box 2760 • Westerville OH 43086

FIRING TIPS is a series of firing problem solvers. New TIPS are available every month. Contact your Orton supplier for your copy.

4. Time and temperature profile during the burn out period

Both time and temperature are important for proper burn out of the carbon. Some carbons require much higher temperatures than others. Oxidation should be completed below red heat (1400°F).

Carbon burns out from the surface first. As more oxygen penetrates the body, then more carbon is reacted to form the CO or CO₂ gas and the burn out process continues. If there is sufficient time, temperature and oxygen, then complete burn out occurs. If these conditions do not exist, the resulting incomplete burn out is referred to as black coring (where the center of the piece has a black or gray cast).

Incomplete Burn Out

Incomplete burn out can result in several firing problems including:

1. Bloating of the ware

If the temperature is hot enough, the outside of the piece will seal up before all the gases can escape. As the body becomes plastic due to glass forming, gases trapped inside the body expand with heat and cause bloating and sometimes cracking of the ware.

2. Glaze defects, such as pinholes

The escaping gases will push through the glaze surface and cause bubbles which pop. If these do not heal, then pinholes will result.

3. Appearance of fired bisque

Where carbon burn out is incomplete, the piece will have a grayish cast (white bodies) or may have a greenish cast (red bodies). The body will also be more porous and weak.

Preventing Incomplete Burnout

1. Slow down the firing.
2. Be sure the kiln is vented adequately so there is sufficient oxygen.
3. Load the kiln with burn out requirements in mind.

Leave plenty of space between ware and shelves. Do not stack ware. Use tile and plate stackers and invert pieces on top of one another to help conserve space and insure proper burnout.

Want to learn more?

Read more about carbon related glaze and body defects in the Orton Firing Line and Technical Tips publications. Each issue is packed full of articles to help you learn more about firing. Members of the Orton Firing Institute receive these publications at no charge. Single copies are available to non-members at a per issue rate. Orton's 80 minute video, *Key Principles of Successful Firing*, is also an excellent resource on firing.

For information on Orton products, see your Orton dealer or distributor. For information on the Firing Institute or publications, contact

Orton Firing Institute, PO Box 460,
Westerville OH 43086, 614-895-2663.

Firing Tips

FIRING HANDBUILT OR THICK CAST WARE

Most pinch pots, coiled or slab built ware generally have thicker walls than their slip cast cousins, although molded pieces may be cast heavily as well. With these types of pieces, the thicker walls create some unique challenges for firing.

Basic problems that can occur when firing handbuilt or thick cast ware include cracking (or exploding) and carbon burnout. Because of the thicker walls it is important to fire slower and control heating and cooling during firing. Preparation of the piece is important as well.

During forming, stresses within the piece may result in hairline cracks that appear during firing. It takes longer to fully dry a thick piece. Uneven drying can result in warping or cracking.

For pieces properly prepared, handled and dried, the next critical step is firing.

Firing issues

- Is the ware fully dry?

Ware that is not adequately dried will crack or explode during the early stages of firing. Water inside the pores of the ware turns to steam, exerting pressure inside the ware. To fully dry a thick walled piece, the ware needs to be warm for more than 12 hours.

- Am I firing too fast?

All bodies expand when heated and shrink when cooled. If the outside wall expands more than the inner wall, stresses occur. If these stresses are large enough, they pull the body apart and cause cracking. A 1" thick wall can have more than a 10°F difference in temperature between the hotter and cooler surfaces. Firings need to be slowed down for thicker wall pieces. Likewise, it is important not to cool too fast.

- Have I allowed enough time for carbon burnout?

It is important to burn out all carbon from the ware before higher temperatures are reached (1200°F or 650°C). It takes time for oxygen to move into the porous body, react with the carbon and then leave. If carbon remains, many problems can occur. These include problems with color, glaze fit, strength, blistering and discoloration. Use of a downdraft vent system, combined with slower heating, virtually eliminates carbon-related problems.

Heating & cooling control

The best way to control cracking problems during firing is by controlling the rate of heating and cooling for the kiln.

**Orton**

SM The Edward Orton Jr. Ceramic Foundation
6991 Old 30 Highway
Westerville OH 43082

FIRING TIPS is a series of firing problem solvers. New TIPS are available every month. Contact your Orton supplier for your copy.

During firing, materials that make up the body undergo many changes. Special care must be taken at temperatures below 1500°F (815°C) to heat the body uniformly.

Remember, the thicker the wall, the slower the heating should be done. Above 1500°F, temperatures can be increased more rapidly because the changes are less likely to cause stress cracks within the ware.

- What kind of changes occur?

All clays and many minerals contain water which does not leave the body until above 700°F. Organic (carbon) materials need to be oxidized (burned out). Other minerals, such as calcite, break down and give off a carbon dioxide gas. Minerals such as flint (silica) undergo a sudden expansion on heating to 1060°F and contraction during cooling.

- How can I control my heating?

This depends on the controls for the kiln. With switches, leave them on medium settings longer. It should take more than 3 hours to reach red heat and even longer for thick pieces or a heavily loaded kiln.

Make sure the kiln is well vented below red heat and closed up completely above red heat. Keep the kiln closed during cooling for 8 hours or until well below red heat.

- When did cracking occur?

Often the crack itself can be examined to determine when it occurred. If the edges are sharp, then it probably occurred during cooling. If the edges are rounded or if glaze has flowed into the crack, then it occurred during heating.

- What else can cause cracking?

1. Uneven heating is a primary culprit that causes cracking during firing.

Hot and cold spots in the kiln can cause uneven heating of pieces.

Use witness cones to diagnose hot and cold spots and then adjust the switching or use a downdraft vent to help even out the heating.

Careful loading of the ware in setters and on stilts can also help heat circulate around the piece.

2. Underfired bisque is not as strong and may crack more easily during the glaze firing.

Use witness cone to assure a proper firing and prevent underfired bisque.

3. Gas expanding in air pockets which developed in the ware during forming can cause large cracks during firing.

Want to learn more?

Read more about firing handbuilt and thickcast ware in the Orton Firing Line and Technical Tips publications. Published 8 times a year, each issue is packed full of articles to help you learn more about firing. Members of the Orton Firing Institute receive these publications at no charge. Single copies are available to non-members at a per issue rate.

For information on Orton products, see your Orton dealer or distributor.

For information on the Firing Institute or publications, contact

Orton Firing Institute, 6991 Old 3C Hwy.,
Westerville OH 43082, 614-895-2663

**Orton pyrometric cones and bars • KilnVent systems
kiln accessories and firing supplies • Orton Firing Institute**

Firing Tips

FIRING CERAMIC BODIES

Most bodies and glazes contain clay. These fine clay particles give the body and glaze many desired properties and bonds other materials together.

When the body is fired:

- clay and other minerals in the body start to change
- clay/minerals break down and react with other materials to produce gases
- at 900 F (red heat), tightly held water molecules begin to break free and leave
- gases such as sulfur oxides and some fluorine may be released
- as the temperature increases, clay and other minerals continue to change and react with each other to form new compounds that will be part of the final product
- some products form glass which will bond everything together

Gases

The gases which form need to be removed from the body. For example, carbon is in the clay and organics are added to the body, glaze or decoration to improve strength during handling or application. These must be removed during firing to avoid defects.

Firing Conditions

Firing conditions can also determine many properties of the fired product. Firing too fast at lower temperatures may not allow sufficient time for materials to react and gases to leave the body or glaze.

Firing too fast can result in

- weaker bodies
- pinholing
- bubbling of the glaze
- color changes in the body
- color changes in the decoration
- mildewing of porcelain
- crazing or peeling of glazes if body is not properly mature

TYPES OF BODIES

Earthenware

- typically fired from Cone 07 - 03
- made with talc, less expensive clays
- clays contain many impurities, need fired longer at lower temperatures
- low shrinkage
- porous after firing
- usually tan or red in color
- frequently glazed or stained
- sometimes used as-fired.



The Edward Orton Jr.
Ceramic Foundation
PO Box 460 • Westerville OH 43081

FIRING TIPS is a series of firing problem solvers. New TIPS are available every month. Contact your Orton supplier for your copy

Often, problems arise because bodies are underfired. The piece may look okay, but is porous and weak. Also, underfired bodies may not match the expansion of the glaze used in a later firing. This can result in glaze fit problems or cracking of the body in use.

The high iron and carbon content of these clays requires plenty of air during firing to maintain good color and to burn out all of the carbon. If this is not done, many problems can occur when the product is glazed and refired.

Stoneware

- typically fired between Cone 6 -10
- large number of compositions
- contain clays and other minerals with many impurities, including sand, feldspar and grog
- additives are used to provide plasticity, workability, strength, color and to reduce shrinkage
- colors depend on raw materials

Because of the additives and impurities, care needs to be given to how stoneware is fired and to proper ventilation of the kiln early in the firing to burn out organics.

Stoneware is vitreous and contains a high percentage of glass in the fired product. For color variations, mature the ware under reducing conditions.

Porcelain

- typically fired from Cone 3 - 10
- compositions vary, but contain high quality materials
- colorants may be added.
- bodies are hard, white, translucent
- very high glass content

- narrow firing range - need to be fired close to slump or sag point for best fired properties.

Because color is very important, these bodies need to be fired with plenty of air below red heat to be sure all the carbon is removed. Shrinkage is high and special care must be given to supporting porcelain during firing or it will warp and distort.

CRITICAL FIRING PERIODS

For all clay containing bodies and for most glazes and decorations:

- be sure ware is dry before firing
- fire slowly below red heat (1100 F) where many changes occur in the clay and other materials
- provide plenty of air below red heat for oxidation and to burn out organics and carbon
- do not to force cool the kiln while it shows red heat.

Want to learn more?

Read more about successfully firing ceramic bodies in the Orton Firing Line and Technical Tips publications. Published 8 times a year, each issue is packed full of articles to help you learn more about firing. Members of the Orton Firing Institute receive these publications at no charge. Single copies are available to non-members at a per issue rate.

For information on Orton products, see your Orton dealer or distributor. For information on the Firing Institute or publications, contact

Orton Firing Institute, PO Box 460,
Westerville OH 43081, 614-895-2663.

**Orton pyrometric cones and bars • KilnVent systems
kiln accessories and firing supplies • Orton Firing Institute**

Firing Tips

FIRING LEAD FREE GLAZES

Changes in glazes

Lead free glazes are becoming the standard for commercial use. This is due to government regulation and health concerns by the manufacturers.

As the name implies, lead free glazes are made from compositions or materials where lead has not been added.

To eliminate lead, glazes are reformulated. This can change some of their properties. Some of the differences you may notice include:

- does not flow or run as much in firing as lead containing glazes
- brush marks may show after firing
- not as wide a firing range
- may not be compatible with as many bodies (improper fit). This leads to shivering or crazing of the glaze.
- color does not match lead glazes
- more surface defects

For problem-free results with lead free glazes, firings must be more closely controlled and kilns well vented. Bodies may have to be bisqued to a higher or lower cone number to solve a problem.

Why do problems occur?

Lead softens a glaze and allows it to be fired over several cone numbers. Glazes made without lead have a narrower firing range. Typically, lead glazes are able to be fired over a four cone number range (example 08 to 05).

Lead free glazes typically need to be fired within two cone numbers (example 06-05) - less than half of that for lead glazes.

Glaze and body fit

Since the glaze and the body on which it is fired (bisque) are made from different materials, it is important that they expand and shrink a like amount when heated and cooled. If they don't, then the fired glaze can be stretched to the point where it can crack (crazing), or it can be pushed together on to itself to a point where shivering or crawling occurs.

When using lead free glazes:

1. Make test firings of the body and glaze to their recommended cone number, first the unglazed body and then the glazed bisque.

 **Orton**

The Edward Orton Jr. Ceramic Foundation
6991 Old 30 Highway
Westerville, OH 43082

FIRING TIPS is a series of firing problem solvers. New TIPS are available every month. Contact your Orton supplier for your copy.

2. Use witness cones placed near the ware to be sure the proper cone number was reached. Differences may exist between the Kiln-Sitter® and a witness cone or from the top to the bottom of the kiln. Firing with a controller to a cone number or a temperature may not be adequate.
3. If crazing occurs and the witness cone indicates the glaze and bisque firings are properly fired, make some tests by firing the bisque progressively hotter (e.g. if you fire bisque to 05, test to 04, then 03).

When you fire hotter, the expansion of the bisque is changed and glaze on the bisque may fit better.

4. If shivering occurs, fire one cone cooler. You may need to select another body for your bisque. Firing too cool is not a good idea since the strength is reduced and porosity increased, both of which may cause problems during use of the final piece.

Is Your Kiln Uniform in Temperature?

If temperature in your kiln varies by more than 1 to 2 cones, then glazed ware in one part of your kiln may fire okay, while ware fired in another part of your kiln will have a problem.

Most kilns vary in temperature from top to bottom. To determine how much your kiln varies, place witness cones on each shelf when making firings. Usually, there is less difference top to bottom for hotter firings.

Each kiln has its own personality and the solution for improving temperature uniformity may vary.

If you have glaze firing problems because

of too much variation, then we recommend the following:

1. Make sure cracks and holes are repaired to keep heat in your kiln.
2. Fire slower during the early part of your firing, before red heat (below 1200°F). This allows heat to soak into the refractory and even out temperatures in the kiln.
3. Consider changing the switching pattern to even out top and bottom temperatures. Switch the bottom to a higher setting before the top or vice versa. Higher settings add more heat.
4. Consider adding an Orton KilnVent. These pull hot gases from the top to the bottom of the kiln and cut temperature variations in half. Hoods above the kiln will not help temperature uniformity problems.

Want to learn more?

Read more about glaze and body fit, heat distribution and measuring heatwork in the Orton Firing Line and Technical Tips publications. Published 8 times a year, each issue is packed full of articles to help you learn more about firing. Members of the Orton Firing Institute receive these publications at no charge. Single copies are available to non-members at a per issue rate.

For information on Orton products, see your Orton dealer or distributor.

For information on the Firing Institute or publications, contact

Orton Firing Institute, 6991 Old 3C Hwy., Westerville OH 43082
614-895-2663.

**Orton pyrometric cones and bars • KilnVent systems
kiln accessories and firing supplies • Orton Firing Institute**

Firing Tips

FIRING RED GLAZES

Red glazes are among the liveliest, brightest colors we can use, but unfortunately, red glaze problems are legendary. Many of us simply give up using reds or accept whatever results we can get, including the problems.

Common Red Glaze Problems

improper color development - dark bluish or purple cast to the glaze

color loss - glaze looks gray, white

poor surface texture - a rough matte finish and/or visible surface defects

"The Strawberry Effect" - tiny black dots or spots in the fired glaze

crazing - a crackled or cracked appearance in the fired glaze

Some of these problems relate to the preparation of the piece and application of glaze, but many defects are the result of improper firing practices.

Preparation and Application

1. ware must be clean and free of dust
2. do not apply red glaze to greenware
3. apply only to properly fired bisque (use witness cones to verify firing) -
4. work area and tools should be kept clean and free of contaminants
5. no eating/smoking in glazing area
6. glaze away from cleaning areas
7. apply adequate coats of glaze - four coats is often recommended

8. allow each coat to dry

How Colors Develop

Many ceramic glazes need to be fired in an oxidizing (air) atmosphere for best results. Red, orange and yellow glazes in particular are very oxygen sensitive. This means they require sufficient air during the firing to bring out the colors to their fullest and to prevent surface/finish defects.

Firing reds requires us to control the firing rate and properly vent the kiln.

Controlling the Firing Rate

Nearly all ceramics fire better when fired slowly below red heat. Slow firings have the advantage of allowing the necessary physical and chemical changes to occur in the ware. Slower firings also permit time for sufficient air to enter the kiln and displace the carbon monoxide. This is true for both bisque and glaze firings.

Firing rate can be controlled using the settings on an automatic kiln, programming an electronic controller or by adjusting the switching. Control or slowing of the firing rate is most important in the early stages of the firing when most of the reactions are occurring and when air is needed to

 **Orton**

The Edward Orton Jr.
Ceramic Foundation

PO Box 2760 • Westerville OH 43086

FIRING TIPS is a series of firing problem solvers. New TIPS are available every month. Contact your Orton supplier for your copy

burn out the organics in ceramic materials. Near vitrification (the end of the firing) a faster rate is desirable and can usually be applied.

Venting for Proper Air

It is most important that enough air gets into the kiln in the early stages of firing. This is when the organic materials are burning out of the ware and air reacts with carbon to form carbon monoxide. Kilns can be vented manually or with an automatic venting system.

Manual Venting

Manual venting lets the fumes out of the kiln, but is only somewhat successful at letting air into the kiln. For manual venting, the top lid should be propped and the peephole plugs out for at least the first hour and a half. Slower firings require additional time. When the kiln reaches red heat, the lid can be closed and peephole plugs replaced. Leaving the peephole plugs out for the whole firing is not recommended since it can cause cold spots in the kiln.

Manual venting works better with a smaller load. Also, using split shelves allows air circulation and helps ventilation.

Manual venting is recommended whenever a downdraft vent is not available. When venting manually, it may be desirable to locate red glazes on the top shelf to assure sufficient air.

Automatic Downdraft Venting

A downdraft automatic venting system like the Orton KilnVent efficiently brings the proper amount of air into the

kiln and removes the fumes for exhausting. The kiln lid and peepholes remain closed the entire firing. Using the Orton Vent, tests have shown reds can even be fired with other colors with good results.

Firing to Proper Cone Number

Using witness cones on the kiln shelf to verify results is important to good results. Many problems occur when red glazes are not fired to the proper cone number. Blistering can occur if underfired and loss of color if overfired. Glaze on underfired bisque may craze. Firing lead free glazes to the proper cone number is especially important.

Firing reds can be a challenge, but by following good preparation, application, firing and venting practices, and by firing to the proper cone number, most problems can be eliminated.

Want to learn more?

Read more about Firing Reds in the Orton Firing Line and Technical Tips publications. Each issue is packed full of articles to help you learn more about firing. Members of the Orton Firing Institute receive these publications at no charge. Single copies are available to non-members at a per issue rate. Orton's 80 minute video, *Key Principles of Successful Firing*, is also an excellent resource on firing.

For information on Orton products, see your Orton dealer or distributor. For information on the Firing Institute or publications, contact

Orton Firing Institute, PO Box 2760,
Westerville OH 43086, 614-895-2663.

**Orton pyrometric cones and bars • KilnVent systems
kiln accessories and firing supplies • Orton Firing Institute**

Firing Tips

UNDERSTANDING CRAZING

What is Crazing

Crazing is one of the most common problems related to glaze defects. It appears in the glazed surface of fired ware as a network of fine hairline cracks. The initial cracks are thicker and spiral upward. These are filled in horizontally with finer cracks.

Crazing is caused by the glaze being under too much tension. This tension occurs when the glaze contracts more than the body during cooling. Because glazes are a very thin coating, most will pull apart or craze under very little tension.

Crazing can make foodsafe glazes unsafe and ruin the look of a piece.

There are two types of crazing, each with a different cause:

immediate crazing

- appears when piece removed from kiln or shortly thereafter
- caused by glaze body fit (glaze fits too tightly to body)

delayed crazing

- shows up weeks/months later
- caused by moisture getting into ware

Immediate Crazing

Size Changes During Firing

All ceramic bodies change in size during heating (firing) and cooling. What is desired is for the glaze to shrink a little more than the body during cooling. If it doesn't then glaze problems may occur.

It is important for ware and glaze expansion and shrinkage to match or crazing can occur.

Glazes During Firing

1. during firing, glaze undergoes physical and chemical changes
2. as heating progresses, glaze melts
3. with further heating more liquid forms until viscous or thick fluid
4. more heating, more fluid glaze
5. at this point, viscous (thick flowing) glaze still conforms to size of the bisque.
6. any gas evolving from body will form blisters which can heal if glaze is still fluid
7. when kiln shuts off, glaze and body cool together
8. during cooling, both the body and glaze shrink
9. eventually glaze becomes a hard glass that will no longer flow

 **Orton**

The Edward Orton Jr.
Ceramic Foundation
PO Box 460 • Westerville OH 43081

FIRING TIPS is a series of firing problem solvers. New TIPS are available every month. Contact your Orton supplier for your copy.

Thermal expansion/shrinkage properties of both the body and the glaze determine if the glaze crazes.

Glazes are designed to shrink less than the body which puts them in compression, makes them stronger, and makes them less susceptible to crazing.

Solution to Glaze and Body Fit

1. test samples for a good fit
2. bisque to 1-2 cone numbers hotter than glaze to insure body is mature
3. use Self-Supporting Witness Cones to verify heatwork
4. recognize that bodies and glazes will have different fits for different heatwork. A glaze might fit bisque fired to 03, but craze on 07 bisque

DELAYED CRAZING

This type of crazing shows up weeks or months later and is practically always caused by underfiring.

If ware is underfired (does not reach maturity), it can, in time, expand when moisture fills the pores causing the body to expand. Sudden changes in temperature can cause crazing if the body and glaze do not expand or contract uniformly.

Either the body expanding or the glaze shrinking can cause fine hairline cracking (crazing) to occur. Refiring to the proper cone will sometimes solve the problem.

Proper Firing

Firing to the proper cone number is critical to help eliminate crazing problems. Witness cones must be used

to verify the heatwork the ware receives.

If the Kiln-Sitter® turns the kiln off and a witness cone is not properly deformed, then the ware is not fired to maturity.

Underfiring can occur because of:

- variations in kiln heating uniformity
- Kiln-Sitter® out of adjustment and shutting kiln off early
- controller thermocouple inaccurate
- differences in heatwork between kiln shelf and Kiln-Sitter® location

Crazing can also be reduced by slower cooling and slower firing.

LEAD FREE GLAZES

Lead-free glaze formulations today have less of firing range. They develop their fired properties more quickly and this makes proper firing more critical.

Want to learn more?

Read more about crazing in the Orton Firing Line and Technical Tips publications. Published 8 times a year, each issue is packed full of articles to help you learn more about firing. Members of the Orton Firing Institute receive these publications at no charge. Single copies are available to non-members at a per issue rate.

For information on Orton products, see your Orton dealer or distributor.

For information on the Firing Institute or publications, contact

Orton Firing Institute, PO Box 460,
Westerville OH 43081, 614-895-2663

**Orton pyrometric cones and bars • KilnVent systems
kiln accessories and firing supplies • Orton Firing Institute**

Firing Tips

SOLVING GLAZE DEFECTS BLISTERS, CRATERS and PINHOLES

Blisters, craters and pinholes are related glaze surface defects. They show up as a rough, grainy or bubbled surface on the ware and appear after the glaze firing or decorating firing.

What Causes These Defects?

This family of problems can be caused by many different factors including:

- dust and contamination in the glaze
- air bubbles in the glaze
- air trapped in the slip
- improperly mixed slip
- a dirty kiln

Most commonly, however, the problems are related to gases coming from the body, glaze or kiln atmosphere.

What Happens During Firing?

Clays and glazes contain organic materials. When heated, these burn out of the body, forming gases such as carbon, sulfur and water.

If the carbon in materials is not fully removed from the body, then gas will form during the glaze or decorating firing, forming bubbles or blisters. These may pop to become craters or pinholes.

These defects can occur because:

1. There was not enough air in the kiln during firing for the carbon to properly burn out.

Any combustion process requires air. Without air, oxidation cannot occur.

2. Carbon monoxide formed by oxidation of carbon has not been adequately removed from kiln.

If the gases produced during firing are not removed from the kiln, they may deposit onto the glaze surface or affect the glaze color.

3. The kiln was heated so quickly that there was not enough time for the carbon to burn out.

Carbon which is only partially burned will continue to oxidize during the glaze or decorating firing causing defects.

4. The ware was underfired. That is, there was not enough heatwork.

When the body is underfired, it is weaker and its expansion may no longer fit the glaze.



[®]
The Edward Orton Jr. Ceramic Foundation
6991 Old 3C Highway
Westerville OH 43082

FIRING TIPS is a series of firing problem solvers. New TIPS are available every month. Contact your Orton supplier for your copy.

How Do I Solve Glaze Defects?

To make sure that glaze defects do not occur, it is important to properly mix glazes and slips and to use good pouring (slip) and application (glaze) techniques. Proper housekeeping for the kiln and workplace should be observed. Straining glaze through nylon often helps remove any lumps.

Most critical for good results are proper firing practices. We recommend the following:

1. Bring air into the kiln and make sure it circulates around the ware especially during bisque firings:
 - use setters and stilts to improve air flow around the ware
 - use half shelves to improve air flow through the kiln
 - adequately vent the kiln
 - position ware to take best advantage of air flow in the kiln

Use a downdraft vent like the Orton KilnVent to bring a controlled amount of air into the kiln and circulate it throughout the kiln. This helps remove fumes and even out the temperatures in the kiln.

2. Control the firing.

Fire slower, especially below 1200°F (650°C). Slow down the firing by adjusting switches to lower settings or soak/hold at a temperature to allow carbon to burn out.

Use an automatic controller to set heating rates and hold times.

3. Use witness cones to verify heat-work.

Underfiring can occur due to burned out heating elements, an improperly adjusted Kiln-Sitter®, a controller thermocouple which has changed or differences in heating within the kiln. Witness cones give a true reading of the heatwork the ware received.

Witness cones placed throughout the kiln show differences in heat distribution.

4. Vent the kiln to remove gases and prevent them from redepositing on ware. Only downdraft venting removes the gases from the kiln.

If good firing and venting practices are observed during firing, problems with glaze surface defects can be controlled.

Want to learn more?

Read more about glaze surface defects in the Orton Firing Line and Technical Tips publications. Published 8 times a year, each issue is packed full of articles to help you learn more about firing. Members of the Orton Firing Institute receive these publications at no charge. Single copies are available to non-members at a per issue rate.

For information on Orton products, see your Orton dealer or distributor.

For information on the Firing Institute or publications, contact

Orton Firing Institute, 6991 Old 3C Hwy., Westerville OH 43082, 614-895-2663.

Orton pyrometric cones and bars • KilnVent systems
kiln accessories and firing supplies • Orton Firing Institute

Firing Tips

SUCCESSFUL GLASS FUSING

Probably the most common problem encountered when fusing glass is that it breaks during firing. There are several causes, including:

1. glass incompatibility
2. glass sticking to shelves
3. glass heated too rapidly
4. glass annealed too quickly

Glass Compatibility

To be compatible, glasses must expand and contract at the same rate when heated and cooled. When this does not occur, they are considered incompatible.

If incompatible glass is fused together and then cooled, stresses will occur in the piece. If the stress is excessive, the fused glass will break either immediately upon cooling or months or even years later.

Glasses are rated using a coefficient of thermal expansion scale. This is based on the linear size change or expansion during heating.

What this means is that the amount the glass expands during heating is

measured and compared to a scale. The larger the number, the greater the expansion. Glass with low expansions will have greater resistance to thermal shock and breaking or cracking.

When you purchase glass, be sure all of the materials you are planning to use in a piece have similar expansion (coefficient) numbers.

Glass Sticking

If kiln wash (shelf primer) is applied unevenly or bare patches are left, the glass may stick as it moves (expands) during the firing process. When this happens, the glass can pull itself apart and break.

Kiln wash should be cleaned off and reapplied in a thin even coating to prevent sticking problems. Take care not to use too much shelf primer as it may require sandblasting to remove it from the bottom of the fired piece.

Glass Heating Too Rapidly

Thermal shocking of glass during



The Edward Orton Jr.
Ceramic Foundation
PO Box 2760 • Westerville OH 43086

FIRING TIPS is a series of firing problem solvers. New TIPS are available every month. Contact your Orton supplier for your copy.

heat up can lead to uneven heating and cracking of the piece. Thermal shocking means that the surface of the glass changes temperature rapidly.

When fusing glass, it is important to control the heating rate between about 150°F and 500°F. For larger or thicker pieces more time is needed. Glass fired in a mold is more susceptible to uneven heating since contacts with the cooler refractory (mold) can lead to uneven heating.

Direct radiant heat from heating elements needs to fall uniformly on the glass or it can cause uneven heating. Most glass firing is done in electric kilns, often with elements above the glass.

Glass Annealed Too Quickly

Annealing is done to reduce stresses in the glass that can result in cracks or breaks. Typically annealing is accomplished by soaking during the cooling cycle (at about 900°F) and then slow cooling between 900°F and 500°F. The amount of time the glass is annealed depends on its thickness. Annealing permits all the glass to equalize in temperature.

When glass is annealed too quickly, stresses can remain that can cause cracking.

When thick sheets or pieces of glass are being annealed, a process called firing down may be necessary. Firing down is done during the slow cooling phase of annealing. Firing down is

used if the kiln is unable to maintain the slow cooling rate required for the piece. The process of firing down involves adding a small amount of heat to the kiln as it cools.

The best way to control cooling during annealing is to use an automatic controller. The desired anneal temperature, soak time and cooling rate are set and the kiln operates automatically. Temperature is displayed. However, even with a controller, the cooling rate set by the operator may be too fast for the kiln to achieve. It is necessary to monitor the temperature change to insure the proper annealing and cooling down occurs.

The thickness of the glass being fired

Want to learn more?

Read more about annealing and firing glass in the Orton Firing Line and Technical Tips publications. Each issue is packed full of articles to help you learn more about firing. Members of the Orton Firing Institute receive these publications at no charge. Single copies are available to non-members at a per issue rate. Orton's 80 minute video, *Key Principles of Successful Firing*, is also an excellent resource on firing.

For information on Orton products, see your Orton dealer or distributor. For information on the Firing Institute, video or publications, contact

Orton Firing Institute, PO Box 2760,
Westerville OH 43086, 614-895-2663

**Orton pyrometric cones and bars • KilnVent systems
kiln accessories and firing supplies • Orton Firing Institute**

Firing Tips

SUCCESS WITH GOLDS

Gold overglazes are known as liquid precious metals. They are expensive and because of this they are traditionally used only for decoration.

Golds are typically used to add detail or distinction to plates, cups and china blanks.

There are several types of gold available in different forms, including bright golds and burnished golds.

Bright Golds

These are gold overglazes. They are not solid gold; instead they contain some percentage of gold, usually about 5 to 15%.

They come as a liquid solution and are usually applied with a brush to reduce waste. A thin coat is preferred to prevent the decoration from running, or failing to adhere.

If the liquid gold becomes too thick, it can be thinned with gold essence. Both of these products are very expensive and come in small vials or bottles.

Burnished Gold

Burnished golds are also gold overglazes. They differ from bright golds in that they require finishing (burnishing) to develop a lustrous finish and bright sheen.

Burnished golds are more durable and have a higher resistance to scratching than other golds. Their appearance is very rich and dense and slightly more matte. The brightness or matte quality can be controlled by application. A thinner application makes for a brighter gold.

Burnished golds contain 16-32% gold, including gold powder. Burnished golds are available in several forms: liquid, paste, dry powder or concentrated pats. The dry powder is extremely expensive.

There are some burnished golds that do not require polishing. These contain between 12 and 20% gold.

Firing Golds

Golds generally fire in the 022 to 018

**Orton**

The Edward Orton Jr.
Ceramic Foundation
PO Box 2760 • Westerville OH 43086

FIRING TIPS is a series of firing problem solvers. New TIPS are available every month. Contact your Orton supplier for your copy.

cone range. This can vary greatly depending on the gold itself and the ware it is being used on. For typical glassware, an 022-021 firing is the most common. For china blanks, the gold can fire as high as 011. Follow the instructions of the manufacturer when firing golds.

Gold will adhere best with a slow firing and a soak. This helps them to develop the proper color and finish. A faster firing increases the risk of surface defects which can be magnified through washing or use.

Golds contain heavy solvents which make kiln ventilation a must for both health and safety reasons and to bring air into the kiln. Usually gold is fired alone to reduce contamination problems.

Typical Gold Faults

Most gold faults are surface defects. These include:

cloudy appearance

caused by inadequate ventilation or too heavy application, firing too fast or overfiring

gold not adhering

caused by underfiring or too heavy application

gold is running

caused if application is too heavy

burnished gold is dull

caused by insufficient burnishing or possible underfiring

dull or scummy appearance

caused by inadequate ventilation or possible overfiring

cracking in finish

caused by firing too fast

pinholes and blemishes

caused by poor quality of gold or contamination of gold

blisters

caused by heavy application

Application and proper firing are the key to great gold results. Gold should be applied in moderation using a very light coating. Be sure to vent the kiln until it glows red hot. Use witness cones to verify the proper heatwork was achieved.

Want to learn more?

Read more about using golds in the Orton Firing Line and Technical Tips publications. Each issue is packed full of articles to help you learn more about firing. Members of the Orton Firing Institute receive these publications at no charge. Single copies are available to non-members at a per issue rate. Orton's 80 minute video, *Key Principles of Successful Firing*, is also an excellent resource on firing.

For information on Orton products, see your Orton dealer or distributor. For information on the Firing Institute or publications, contact

Orton Firing Institute, PO Box 2760, Westerville OH 43086, 614-895-2663.

**Orton pyrometric cones and bars • KilnVent systems
kiln accessories and firing supplies • Orton Firing Institute**

Firing Tips

SUCCESS WITH DECALS

Decals offer an opportunity to add decoration to ceramic and glass ware without the time and skill required for hand painting. When properly applied and fired, decals can add color, texture, design and personalization to a piece.

To achieve professional results with decals, it's important to understand how to select, apply and fire the decals.

- type of decals
 - different decals are made for glass and ceramics
 - ceramic decals often fire hotter than those for glass
- application
 - decals must have good contact with the surface of the ware
 - all wrinkles and bubbles need to be smoothed away
 - avoid tearing the decal
- firing
 - decals are generally low firing - from cone 022 to 016
 - check the package for the proper firing range
- venting
 - decals contain lots of organics which need to be burned off

- often smelly fumes result during decal firings

Firing Decals

A decal isn't fired that much differently than any other piece of ware, although there are some special considerations.

1. Venting is very important to good results with decals - especially to get true colors.

Problems related to venting include:

- poor color development
- a cloudy or hazy appearance

2. Proper heatwork is also an important factor. Decals that are under or overfired may exhibit the following:

- faded colors (overfired)
- color shift (underfired)
- decals rub off (underfired)
- dull appearing metallics (underfired)

Determining Firing Range

Because the colors on decals can so easily be affected by the amount of heatwork they receive, we recommend test firings to determine the best firing range.

 **Orton**

The Edward Orton II Ceramic Foundation
6991 Old 30 Highway
Westerville OH 43082

FIRING TIPS is a series of firing problem solvers. New TIPS are available every month. Contact your Orton supplier for your copy.

Use a series of witness cones to fire samples of the decals on tiles or blanks. Make several firings and then select the fired appearance which looks the best.

Color development

Cloudy looking decals or decals where the color is not bright need to have additional air to develop properly. Organics need to be burned out and carbon monoxide fumes have to be removed from the kiln.

Manual venting by propping the lid and removal of peephole plugs will improve the firing, but may not help bring enough air to the bottom of the kiln or to distribute it evenly throughout the load.

A downdraft vent system will ensure sufficient air is brought into the kiln and circulated throughout.

Measuring heatwork

Heatwork is another critical factor in the color development of decals.

Fading, shifting and dullness are signs of too much or too little heatwork. This is also true when decals rub off after firing. (White or blank spots or burned off areas are generally related to application, not firing.)

Use witness cones to measure heatwork and to check the heat distribution in the kiln. Firing to a temperature or firing to a Kiln-Sitter® cone may not give the same results as found with a witness cone next to the ware.

Measuring heat distribution

Differences in heat distribution from top to bottom in the kiln are usually far more noticeable for cooler firings like decals. A 2 or 3 cone difference at 022 may only be a 1 cone difference at cone 6. This is because at higher temperatures radiation heats the kiln more effectively.

Slowing the first half of the firing can help heat distribution problems. This also helps by allowing more time for air to enter the kiln and burn out organics and for carbon monoxide to leave the kiln.

Use a controller to set heating rates and soaks for more precise firings.

Want to learn more?

Read more about successfully firing decals in the Orton Firing Line and Technical Tips publications. Published 8 times a year, each issue is packed full of articles to help you learn more about firing. Members of the Orton Firing Institute receive these publications at no charge. Single copies are available to non-members at a per issue rate.

For information on Orton products, see your Orton dealer or distributor.

For information on the Firing Institute or publications, contact

Orton Firing Institute, 6991 old 3C Hwy., Westerville OH 43082, 614-895-2663.

**Orton pyrometric cones and bars • KilnVent systems
kiln accessories and firing supplies • Orton Firing Institute**

Firing Tips

MAKING FOODSAFE WARE

When making ware to contain food and beverages, it is very important to be sure it is foodsafe. Some of important considerations for mugs, serving pieces and dinnerware include:

- body composition
- design of the ware
- glaze selection
- decoration
- firing to maturity
- testing for lead safety
- government regulations

What Type of Ware?

The design of some pieces of ware have inherent problems which make them unsuitable to contain food and beverages.

Design-related cracks, rough areas, crevices and nooks and crannies are difficult to clean and might trap bacteria. They can also be difficult to thoroughly glaze. Pitchers with hollow handles can have the same problems.

Ware also needs to be serviceable - that is, it should be strong so it won't fail or break during service.

Making Smart Glaze Choices

While glazes are extremely durable, most are not completely insoluble. If attacked by acids in foods such as orange juice, vinegar and tomatoes, small amounts of the glaze may dissolve and pose a health hazard.

Acid resistant glazes have passed rigorous tests and are labeled as foodsafe. These should be selected for glazing food ware. Lead-free glazes may not be acid-resistant and should not be used unless labeled as foodsafe.

Homemade, altered, crackle, matte or specialty glazes also should be avoided for surfaces of containers that will contact food and beverages.

How to Decorate

When glazing, be sure to completely glaze the ware to ensure the entire body is sealed. Properly bisqued porcelain may be dry footed, but only if the porcelain has been fired to vitrification. Label the ware as foodsafe for future users.

China paints, decals and rim designs

Orton

The Edward Orton Jr.
Ceramic Foundation
PO Box 2760 • Westerville OH 43086

FIRING TIPS is a series of firing problem solvers. New TIPS are available every month. Contact your Orton supplier for your copy.

are a popular way to decorate plates and mugs, but may not be safe for food surfaces. Specific regulations exist for the location of rim decorations which must be followed.

Decals should be used on the outside of a piece where they will not be in contact with food or beverages. Use china paints on decorative items only.

Safe Firing

Proper glaze firing and the bisque firing are very important to insure ware is foodsafe. If the bisque is underfired, it may create problems with glaze and body fit that result in crazing of the glaze, or glaze surface defects such as pinholes. These would not be acceptable for ware used to contain food and beverages.

If the glaze is not properly matured, it will not meet the foodsafe standards under which it was tested and may craze while in service.

Using pyrometric witness cones on the kiln shelf is the only way to insure that a proper firing has occurred. For foodsafe ware, many prefer to fire their bisque to an 03 witness cone just to be sure it is fully mature. Read and follow the manufacturer's instructions for glazes for the best and safest results.

Regulations

There are several very specific regulations for ware which will contain or contact food and beverages. California has the most stringent rules for dinnerware and new standards have been set

by the FDA for rim decorations. These rules are available from state and federal agencies. If you are selling your dinnerware you may be subject to additional regulation.

How to Test for Lead Release

Several easy to use products are available on the market to test for lead release. These are primarily quantitative tests - that is, they tell you yes or no if the surface has lead above a certain level. The most commonly used kit is a thick cotton swab which turns pink if lead levels are exceeded. This test does not harm ware so if it tests too high in lead, the piece can still be used as decoration. These tests are a simple, economical way to feel confident that your ware is safe.

Want to learn more?

Read more about Making Foodsafe Ware in the Orton Firing Line and Technical Tips publications. Each issue is packed full of articles to help you learn more about firing. Members of the Orton Firing Institute receive these publications at no charge. Single copies are available to non-members at a per issue rate. Orton's 80 minute video, *Key Principles of Successful Firing*, is also an excellent resource on firing.

For information on Orton products, see your Orton dealer or distributor. For information on the Firing Institute or publications, contact

Orton Firing Institute, PO Box 2760,
Westerville OH 43086, 614-895-2663.

**Orton pyrometric cones and bars • KilnVent systems
kiln accessories and firing supplies • Orton Firing Institute**

LIBERTY-BELLE INSTRUCTION MANUAL

MAINTENANCE

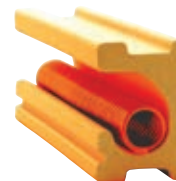

L&L Kiln's patented
hard ceramic
element holders
protect your kiln.

REGULAR MAINTENANCE OF YOUR L&L KILN

WATCH THIS VIDEO

This video shows you the basics of how to do routine maintenance on your L&L kiln:

hotkilns.com/maintaining-kiln

REGULAR KILN MAINTENANCE

To keep your kiln in top operating condition, we recommend the following minimum housekeeping:

AFTER EACH FIRING

1) Turn off the kiln at the circuit breaker or fused disconnect switch.

2) Check element holders and walls for glaze, clay chips or anything that could melt at a high temperature. If melted clay or glaze comes in contact with an element, a rapid failure could result. The molten material traps the heat radiating from the element and subsequently raises the surface temperature of the wire. The temperature will quickly pass the maximum recommended for the wire and burn it up. To clean holders, a good shop vacuum with a HEPA filter will handle dust and loose crumbs. A very gentle chisel or grinder may help with glaze contamination on element holders, but remember that the elements themselves are quite brittle when they are cool. Replace the contaminated holder if you can not clean it. Remove any glaze that has splattered on the firebrick or shelves.

(CAUTION: USE SAFETY GLASSES WHEN DOING THIS BECAUSE GLAZE CAN BE LIKE BROKEN GLASS).

Vacuum afterward.

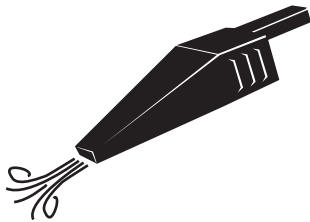

VACUUMING NOTE: It is possible to build up a strong static electricity charge when you are vacuuming. If this somehow manages to discharge into the control it can ruin the electronic circuit. Make sure the vacuum is grounded and periodically touch some grounded metal surface away from the kiln to discharge the energy.

3) Make sure the tops of the shelves are coated with kiln wash as it will keep running glaze from ruining the shelf. Some people also apply the kiln wash to the kiln bottom. Because this has both its benefits and detractants, we recommend that it only be done based on the kiln user's individual preferences. (Do not coat the undersides or the

sides of the shelves because you do not want the kiln wash to fall off into the kiln).

4) Keep a kiln log of firings. Tracking the performance of your kiln over time may turn out to be an extremely valuable tool if you ever need to diagnose future problems. Remember that you can easily get the firing time and final temperature at the end of the firing by hitting the Prog Review button if you have a DynaTrol.

CAUTION: KILN WASH AND CLAY CONTAIN SILICA

1. Long term exposure to silica dust could cause lung damage.
2. See the MSDS sheets.
3. Exercise proper caution when mixing the dry powder and when removing it from your shelves.
4. Use a NIOSH approved particulate respirator for dust and use proper ventilation. You can buy these from safety supply houses. (NIOSH_approval #TC-21C-132 is an example).

AFTER 10 FIRINGS

1) Check temperatures of the main power cord at the main receptacle and the main kiln breaker while the kiln is at its hottest. If these are hotter than normal, it could be a sign of a loose or corroded connection, or possibly the wire gauge used in the power hook-up is the wrong size for the amount of current being drawn by the kiln. Immediately diagnose and fix this because it could cause a fire.

2) If you have a plug on your kiln, unplug it from the receptacle and check for oxidation, any burn marks, discoloration, or melted spots on the plug. If you see this replace the plug (and the receptacle) before using the kiln again. Make sure the receptacle feels tight when you press the plug into the outlet. A loose receptacle indicates worn springs, which will lead to overheating.

NOTE: An oxidation inhibitor can be used on the plug's prongs.

3) Check element resistance. You will need a digital multimeter (see the Troubleshooting Guide). Keep track of this information.

4) Check tightness of case and retighten if necessary. (the case will expand and contract during each firing and may eventually become loose. Brick also shrinks slightly with

REGULAR MAINTENANCE OF YOUR L&L KILN

use - especially if used at the higher temperatures like cone 10).

5) Repair any firebrick problems.

6) If you have a manual kiln (or the Orton AutoCone backup on an automatic kiln) be sure it is properly adjusted. See the AutoCone instructions. Overfiring could result. The tube assembly should be replaced if it gets overly corroded or contaminated with condensed glaze or other materials. Orton recommends checking the pivot point for corrosion and sluggishness every 6 to 12 months.

AFTER 30 FIRINGS OR ANNUALLY

1) Check wires for deterioration or oxidation. Replace any that seem brittle or where the wire insulation has deteriorated or fallen off.

2) Check terminals for oxidation (discoloration). If you are near salt air or if you notice corrosion on the stainless exterior of the kiln for whatever reason then do this far more frequently.

3) Check power connection terminals in the kiln and control box for tightness. Be sure to do this with the power disconnected (unplugged) for the kiln. If these terminal connections get loose, heat can be generated (because the electrical resistance gets greater) and this can cause a fire.

CHECK THERMOCOUPLE CALIBRATION

Thermocouples will drift in reading over time. This could potentially lead to an overfiring before the thermocouple actually fails. Although you can not easily check thermocouple calibration, the general accuracy of the entire kiln system can be checked by firing with witness cones. See *troubleshoot-cones.pdf*.

Replace thermocouples once they are no longer reasonably accurate. (Note: Type K thermocouples last about the same as kiln elements so it is recommended to change thermocouples when you change elements.)

LIBERTY-BELLE INSTRUCTION MANUAL



L&L Kiln's patented
hard ceramic
element holders
protect your kiln.

LIBERTY-BELLE INSTRUCTION MANUAL

TROUBLE
SHOOTING



L&L Kiln's patented
hard ceramic
element holders
protect your kiln.

TROUBLESHOOTING AND REPAIR INSTRUCTIONS FOR L&L KILNS

TABLE OF CONTENTS

TROUBLESHOOTING GUIDE	2	Heat Leakage & Vents	12
VIDEOS	2	Adding More Insulation	12
TROUBLESHOOTING WEB TOOLS	2	KILN FIRES SLOWLY - EASY-FIRE	12
RELATED L&L GUIDES	2	Single vs Three Zone Control	12
CAUTION INSTRUCTIONS	2	ShtO (SHUT-OFF) SETTING	13
REGULAR KILN MAINTENANCE	2	Pld SETTING	13
BASIC ELECTRICITY FOR TROUBLESHOOTING	2	Change elements to graded elements	13
TROUBLESHOOTING BRICK PROBLEMS	2	KILN HEATS TOO FAST	13
TROUBLESHOOTING ELEMENT PROBLEMS	3	Relays	13
TROUBLESHOOTING FIRING PROBLEMS WITH CONE PACKS	3	Voltage	13
THE CERAMIC PROCESS	3	Elements	13
REPLACEMENT PARTS	3	EASY-FIRE ERROR MESSAGES	14
SERVICE	3	Errd	14
GENERAL TROUBLESHOOTING TOOLS AND METHODS	3	Err1	14
BASIC TOOLS REQUIRED	3	Err2	15
KEYS TO GOOD TROUBLESHOOTING	3	Err3	15
SAFETY FIRST	3	Err4	15
DEFINE THE VARIABLES	3	Err5	15
ELIMINATE VARIABLES ONE AT A TIME	3	Err6	15
Err1 (ERROR 1) - THE MOST COMMON ERROR	3	Err7	15
CONTROL DISPLAY DOESN'T SHOW ANYTHING	3	Err8	15
On/Off Switch	3	ErrP + PF	15
Fuse	3	Err-	15
Fuse Holder	3	FAIL	15
On/Off Switch	4	Turning Error Codes On or Off	16
Plug & Cord (if you have one)	4	Can you restart the kiln after it stops because of Error Codes?	16
Circuit Breaker / Power Source	4	Worst Case Scenario for Restarting After an Error Code	16
Control Transformer	4	ONE-TOUCH ERROR MESSAGES	17
Control Board	5	Errd	17
Internal Wiring	5	Err1	17
Short Circuits	5	ErrP	18
EASY-FIRE DISPLAY READS FAIL	5	ErrF	18
EASY-FIRE DISPLAY READS 2400 or CPLt WHEN IT STARTS UP	6	tC	18
ONE-TOUCH CONTROL DISPLAY READS FAIL	6	FAIL	18
DISPLAY IS NORMAL BUT KILN WON'T HEAT UP	7	Can you restart the kiln after it stops because of Error Codes?	18
Programming	7	Worst Case Scenario for Restarting After an Error Code	18
Wiring	7	SERVICE FOR YOUR KILN	19
EASY-FIRE Control Board Outputs	7	WHERE TO GET SERVICE	19
ONE-TOUCH Control Board Outputs	7	WHERE TO BUY PARTS	19
Bad Power Relays	7	REPLACEMENT ELEMENTS	19
Bad Elements	7	REMOVING PANEL FOR SERVICE	19
Run a Simple Paper Test	7	REPLACING DYNATROL	20
KILN FIRES UNEVENLY	7	REPLACING ONE-TOUCH™	20
Peepholes	7	REPLACING TRANSFORMER	21
Lid Seal	7	REPLACING POWER RELAYS	21
Elements	8	REPLACING FUSE HOLDER	21
Loading	8	REPLACING THERMOCOUPLES	22
Firing with Cones	8	CHECKING ELEMENT OHMS	22
EASY-FIRE Thermocouple Offsets	8	Element Ohm Charts	22
ONE-TOUCH Thermocouple Offsets	8	Easy-Fire Element Ohm Chart	22
Vent System	9	School-Master Top Element Ohm Chart	23
KILN FIRES TOO HOT OR COLD	9	School-Master Bottom Element Ohm Chart	23
Firing with Cones	9	CHANGING ELEMENTS	23
Easy-Fire vs Vary-Fire (on DynaTrol)	9	SEE THESE VIDEOS FIRST	23
Be Careful with Hold Times	9	REPLACING ELEMENT HOLDERS	23
Control Settings	9	CRACKS IN THE LID & BOTTOM	23
Thermocouple Drift	9	TIGHTENING STAINLESS BANDS	23
KILN STALLS	9	REPLACING FIREBRICK IN SIDES	23
KILN FIRES SLOWLY - BOTH SERIES	10	DRILLING OUT HOLES FOR PEEPHOLES	24
Run a Simple Paper Test	10	DRILLING OUT FOR ELEMENT CONNECTIONS	24
Bad or Wrong Voltage	10	REPLACING BOTTOMS	24
Element Aging	10	REPLACING LIDS	24
Power Relays	11	MORE ABOUT TROUBLESHOOTING CERAMIC PROBLEMS	24
Bad Wiring	11	Photo of a 1-phase control panel for a three section Easy-Fire kiln	25
Wiring in the Kiln	11		
Element Connections	12		

TROUBLESHOOTING AND REPAIR INSTRUCTIONS FOR L&L KILNS

CAUTION - ELECTRICITY CAN KILL

Many of the tests described in here are performed under power. They should be done **ONLY** by someone who is familiar with electrical safety such as an electrician or trained maintenance person. We identify any test that is live with a CAUTION statement. We describe these tests in detail so that an electrically trained person who doesn't specifically understand kilns can do the troubleshooting - the level of simplicity described is not meant as an invitation to harm the untrained. **AS LONG AS THE KILN IS UNPLUGGED YOU ARE SAFE.**

GET A DIGITAL MULTIMETER!

If you want to do much of the troubleshooting described here and not be dependent on a kiln service person then get this tool. It is not hard to use! Without it you are only guessing at the origin and severity of an electrical problem based on how the kiln is acting. A slow-firing kiln may just have old elements, or the elements could be fine but the incoming voltage from your power supply could be low, or fluctuating. Unless you test with a multimeter, you could purchase new elements and run the risk that you might be wasting money and time without solving the problem. Be forewarned however: Testing electrical circuits is very dangerous and potentially deadly if you do it incorrectly. It could result in electrocution! If you don't feel comfortable doing this hire an electrician or get someone to do it who is qualified. That being said - many of the tests described in here just require testing for resistance - which is done with the kiln unplugged. **AS LONG AS THE KILN IS UNPLUGGED YOU ARE SAFE.**

You can buy an inexpensive digital multimeters for around \$40-\$50. The meter you buy should be digital simply because the analog type is not very accurate. **You must be able to see ohm (resistance) readings to the first decimal place.**



TROUBLESHOOTING GUIDE

This manual is meant to assist and educate kiln owners and service technicians. Our basic philosophy at L&L is to make kilns that last. No small part of having a reliable well-firing kiln is good maintenance. This information is provided as a service and is believed to be accurate. However, it is the reader's sole responsibility to interpret and use this information correctly. Please visit our web site to download the latest versions of all our instructional and technical information.

VIDEOS

ALSO WE ENCOURAGE YOU TO USE THE VIDEOS ON OUR WEB SITE (hotkilns.com/video).

TROUBLESHOOTING WEB TOOLS

The latest troubleshooting information is on the web. This is constantly updated. See hotkilns.com/knowledgebase

RELATED L&L GUIDES

CAUTION INSTRUCTIONS

See CAUTION INSTRUCTIONS FOR L&L KILNS in the CAUTIONS section of your Instruction Manual. **THIS IS SOMETHING YOU MUST READ.** (Also hotkilns.com/cautions)

REGULAR KILN MAINTENANCE

See REGULAR MAINTENANCE OF YOUR L&L KILN in the MAINTENANCE section of your Instruction Manual. **THIS IS SOMETHING YOU MUST READ.**

BASIC ELECTRICITY FOR TROUBLESHOOTING

See BASIC ELECTRICITY FOR TROUBLESHOOTING KILNS in the TROUBLESHOOTING section. Also see hotkilns.com/volts.pdf for more in-depth information about electricity for kilns.

TROUBLESHOOTING BRICK PROBLEMS

See TROUBLESHOOTING AND FIXING BRICK PROBLEMS in the TROUBLESHOOTING section for information on firebrick problems and instructions on how to repair firebrick problems.

TROUBLESHOOTING AND REPAIR INSTRUCTIONS FOR L&L KILNS

TROUBLESHOOTING ELEMENT PROBLEMS

See ELEMENT TROUBLESHOOTING & INSTALLATION INSTRUCTIONS in the TROUBLESHOOTING section for information on elements problems and instructions on how to install elements and element holders.

TROUBLESHOOTING FIRING PROBLEMS WITH CONE PACKS

See TROUBLESHOOTING KILN FIRING WITH CONE PACKS in the LOG, CONES, TIPS section.

THE CERAMIC PROCESS

See THE CERAMIC PROCESS in the LOG, CONES, TIPS section.

REPLACEMENT PARTS

See the PARTS section.

SERVICE

See SERVICE section.

GENERAL TROUBLESHOOTING TOOLS AND METHODS

BASIC TOOLS REQUIRED

The minimal toolkit necessary for effective troubleshooting and fixing of electric kilns contains a digital multi-meter to measure ohms and AC voltage, and an assortment of screwdrivers, nutdrivers, wrenches, pliers, cutters, wire strippers and wire terminal crimpers. As you work on your kiln you will see what types of tools you need, like a 3/8" nut-driver, needle-nose pliers without the cutting part so the tips will close all the way. wire cutters heavy enough to cut the element terminals, wire strippers and wire terminal crimpers. No special tools are required for maintenance on L&L kilns.

KEYS TO GOOD TROUBLESHOOTING

SAFETY FIRST

Pay attention to electrical safety. Don't get electrocuted and don't guess.

DEFINE THE VARIABLES

Define all variables of the situation, and how they could potentially interact with and affect each other in each unique case you come across.

ELIMINATE VARIABLES ONE AT A TIME

Eliminate variables one by one to expose the problem variable(s). Asking questions can do this to some degree. Electrical testing, examining shards of ware or cone, or examining the interior of the kiln usually can supply the rest of the story. Good troubleshooting is based on logic.

Err1 (ERROR 1) - THE MOST COMMON ERROR

This is the most common troubleshooting problem we see. It generally means one of two things. 1) The elements have aged with increased resistance and therefore lower power. 2) A relay is not working. See The section in these instructions on Error Codes, CHECKING ELEMENT OHMS, and various paragraph on checking the relays.

CONTROL DISPLAY DOESN'T SHOW ANYTHING

On/Off Switch

1) Make sure the On/Off Switch is turned on. Turn it on and off.

Fuse

1) Check control fuse in side of control box. Twist open the fuse holder and physically check the fuse. If the metal element inside is melted if it is blown. You can also use your digital multi-meter to check continuity across the fuse. Replace if faulty: hotkilns.com/control-panel-fuse

Picture of the on/off switch and fuse holder opened.



Fuse Holder

If you notice that the fuse holder itself is damaged replace it. See: hotkilns.com/change-fuse-holder

TROUBLESHOOTING AND REPAIR INSTRUCTIONS FOR L&L KILNS

On/Off Switch

The on/off switch rarely needs replacing but if you have to replace that see this video: hotkilns.com/replace-on-off-switch

Plug & Cord (if you have one)

1) Make sure the power cord is plugged into the receptacle. Reseat plug. Make sure it is held firmly and that the springs inside the receptacle seem to be working.

2) With power off examine the electrical cord. Look for burned or melted areas and breaks or pinched sections. Look closely at the head of the plug. If there is an internal problem with the wires and the plug parts you won't be able to see it but you may detect a softening or melting of the plastic at the plug head. Look for oxidation or substantial discoloration or even burnt spots on the prongs. Replace plug and cord if this is questionable.

3) With power turned on and panel open check voltage at the Power Terminal Block. If you see no voltage there then you know something is wrong with the power source.

CAUTION: This test should only be done by an experienced person familiar with electricity and its dangers.

If you have to replace the power cord see this video. It includes video of changing a power cord. hotkilns.com/change-phase-easy-fire

Checking voltage at the power terminal block.

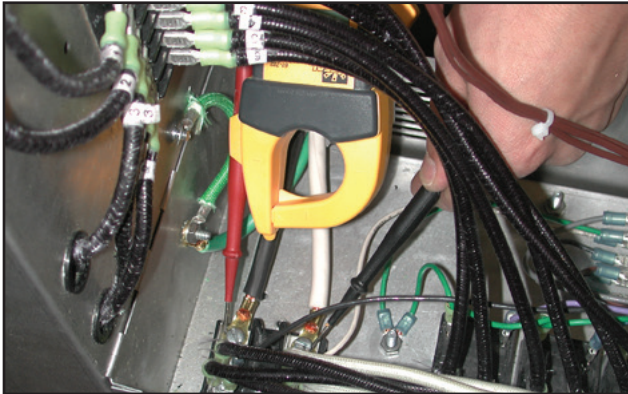

Circuit Breaker / Power Source

1) Check voltage at the receptacle. **CAUTION:** This test should only be done by an experienced person familiar with electricity and its dangers.

A fused disconnect switch.



2) Check circuit breaker or fused disconnect switch to make sure they are turned on. Sometimes circuit breakers need to be turned on and off to reset them.

3) If you have a fused disconnect check the fuses with your voltmeter for continuity. **CAUTION: This test should only be done by an experienced person familiar with electricity and its dangers.**

4) Make sure fuses or circuit breaker are the proper amperage and type. See wiring diagram for details.

5) Test for voltage at the main power supply as close to the kiln as possible. **CAUTION: This test should only be done by an experienced person familiar with electricity and its dangers.**

Control Transformer

See this video: hotkilns.com/check-control-transformer and hotkilns.com/change-transformer.

1) If none of these solve the problem then you could have a bad control transformer. To check the transformer operation test with your digital multimeter. It should read 240 (or 208) volts across terminals 1 & 4 (black and white wires) and 24 volts across terminals 5 & 8 (where the gray and brown wires come out). This is a live test so be very careful not to touch any of the wires - remember there is 240 volts in the panel and this can electrocute you. See photo below. If you are receiving 240/208 Volts in, but not getting the proper approximate 24 Volts out, then you need to replace the control transformer. See: hotkilns.com/control-transformer-12-va

2) If there is no voltage coming into terminals 1 & 4, white & black, then test for it at the Power Terminal Block where the power cord comes in. If there is power there then look for a bad connection or wire between the power connection block and the transformer, i.e. a bad toggle switch, wire, or ½ amp

TROUBLESHOOTING AND REPAIR INSTRUCTIONS FOR L&L KILNS

fuse holder. If power is not there then go further back on the line and measure the voltage. Keep going until you find voltage, then look for the problem between that point with the voltage and the last point checked that had no voltage.

Control Board

1) If the transformer is OK and you know you have voltage going to the control board but the control still shows no display then the control board needs to be replaced.

DynaTrol: hotkilns.com/dynatrol-control-board

Genesis: hotkilns.com/genesis-control-board

One-Touch for School-Master kilns: hotkilns.com/one-touch-control-board-cone-6

One-Touch for Doll, Liberty-Belle and Fuego kilns: hotkilns.com/one-touch-control-board-cone-10

See this for how to replace: hotkilns.com/replace-dynatrol

Internal Wiring

1) Unplug kiln or turn off at circuit breaker or fused disconnect and open up panel. CHECK VOLTAGE TO BE SURE. Make sure that all the wires inside the control panel are connected. See photograph on page 2 or page 3 and also the Wiring Diagram. Specifically look at the wires that go from the power connection block to the on/off switch, then to the control fuse and then to the control transformer.

Short Circuits

Do all the following with the kiln unplugged.

1) Check for short circuits. Look for any signs of burnt wires. This might indicate a short circuit. A way this might happen, as an example, is that frayed wires at the end of a wire connector might touch each other.

2) Check for worn wires that may have shorted against the case. Examine wire insulation. If the wire insulation has become frayed the wires could short to the metal casing which is electrically grounded.

3) Look for dirt. Some dirt (such as carbon compounds) are electrically conductive. This is generally not the case with ceramic materials but some can be. Vacuum out if you see dirt.

NOTE: Usually a short circuit will trip either the circuit breaker for the kiln or the fuses in the fused disconnect switch, if you have one. You will then not see any display on the DynaTrol. Turn your circuit breaker on and off, and check fuses on the fused disconnect and control fuse.

CAUTION: These tests should only be done by an experienced person familiar with electricity and its dangers.

Checking output of the Control Transformer (DANGER-live test).

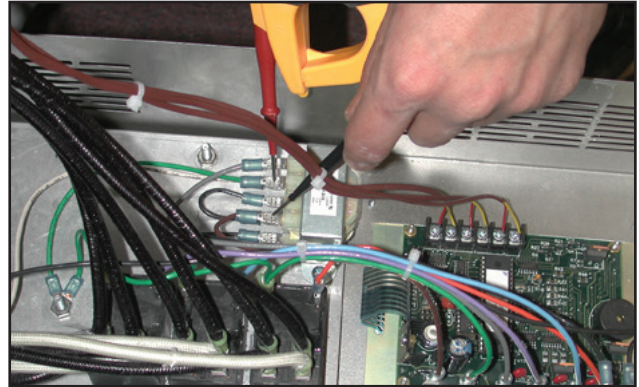

EASY-FIRE DISPLAY READS FAIL

Usually **FAIL** will be seen flashing along with a **tC1**, **tC2** or **tC3** indicating which thermocouple circuit has failed.

Typically this will just mean that your thermocouple(s) need replacing. Overtime the thermocouple tip will corrode and cause a circuit to **FAIL**. We recommend replacing all thermocouples simultaneously rather than as they fail.

See this to replace thermocouple: hotkilns.com/change-thermocouple

1) Unplug the kiln. Open the Control Panel. Remove the offending thermocouples connection wires from the Thermocouple Terminal Strip and bind the red and yellow wires together with electrical tape. Close up the panel and plug in the kiln. The control should read room temperature for that thermocouple (approximately 90 Deg F because of the thermocouple offsets).

2) If it does read room temperature then the thermocouple is probably bad and needs to be replaced. If the control does not read room temperature then there is either a bad thermocouple wire in the Control Thermocouple Harness or the control is bad.

3) Redo the test by putting a small jumper like a paperclip across the thermocouple terminals directly on the DynaTrol board. If the control now will read room temperature then you have a bad thermocouple wire. If it does not read room temperature then the control is definitely bad and needs to be replaced. See this: hotkilns.com/replace-dynatrol

TROUBLESHOOTING AND REPAIR INSTRUCTIONS FOR L&L KILNS

EASY-FIRE DISPLAY READS 2400 or CPLt WHEN IT STARTS UP

Even though you know the kiln is not that hot. This indicates thermocouple circuit failure.

TECHNICAL NOTE: This is called thermocouple upscale protection. If the control senses a lack of millivoltage (an open circuit) it interprets this as the highest temperature the control could reach. This automatically ensures that the control will not call for power.

1) Check thermocouple end. Examine end carefully. Sometimes there can be a crack that opens up while the kiln is hot but appears to be normal when the kiln is cold. If the end of the thermocouple looks severely corroded and you are getting Error codes then it is best to replace the thermocouple. NOTE: You have to open up the Element Cover Box and remove the thermocouples to check the ends.

A thermocouple end that will still work but is getting close to creating a problem.



2) Check thermocouple circuit. For instance check to make sure that all the thermocouple lead wires are firmly connected to the Thermocouple Terminal Strip. Check where the thermocouple lead wires go into the ends of the thermocouples. Are the wires loose? Tighten the screws on the ends of the thermocouples to be sure you have a tight connection. Check for corrosion. Check where the thermocouples connect to the DynaTrol. Try pulling off each connection and reseating it. This can scrape away corrosion that may have built up. Check for melted wires inside the Element Cover Box.

3) A very easy check is to check resistance (ohms) right on the Thermocouple Terminal Strip. Unplug kiln or disconnect from live power by turning off circuit breaker or fused disconnect switch. Open panel. You don't even have to remove the thermocouple wires. Just touch the terminal strip itself with your probes (terminals #1 & #2 for TC1, terminals #3 & #4 for TC2 and terminals #5 & #6 for TC3). If the thermocouples and circuit is normal then you will see a

resistance of about .9 or 1.0. If you see an **OL** in your meter then you have an open circuit somewhere which is probably a bad thermocouple.

4) If you have a bad thermocouple replace it with a new one. Although you may be able to "make it work" by twisting the ends of the wire together this could easily fail during an important load and could also be extremely inaccurate.

ONE-TOUCH CONTROL DISPLAY READS FAIL

Usually **FAIL** will be seen flashing along with a **tC** indicating the thermocouple has failed.

1) Check thermocouple end. Examine end carefully. Sometimes there can be a crack that opens up while the kiln is hot but appears to be normal when the kiln is cold. If the end of the thermocouple looks severely corroded and you are getting Error codes then it is best to replace the thermocouple. NOTE: You have to open up the Element Cover Box and remove the thermocouple to check the end.

See this to replace thermocouple: hotkilns.com/change-thermocouple

2) Check thermocouple circuit. For instance check to make sure that all the thermocouple lead wires are firmly connected to the Thermocouple Terminal Strip. Check where the thermocouple lead wires go into the ends of the thermocouples. Are the wires loose? Tighten the screws on the ends of the thermocouples to be sure you have a tight connection. Check for corrosion. Check where the thermocouples connect to the DynaTrol. Try pulling off each connection and reseating it. This can scrape away corrosion that may have built up. Check for melted wires inside the Element Cover Box.

3) A very easy check is to check resistance (ohms) right on the Thermocouple Terminal Strip. Unplug kiln or disconnect from live power by turning off circuit breaker or fused disconnect switch. Open panel. You don't even have to remove the thermocouple wires. Just touch the terminal strip itself with your probes (terminals #1 & #2 for TC1, terminals #3 & #4 for TC2 and terminals #5 & #6 for TC3). If the thermocouples and circuit is normal then you will see a resistance of about .9 or 1.0. If you see an **OL** in your meter then you have an open circuit somewhere which is probably a bad thermocouple.

4) If you have a bad thermocouple replace it with a new one. Although you may be able to "make it work" by twisting the ends of the wire together this could easily fail during an important load and could also be extremely inaccurate.

TROUBLESHOOTING AND REPAIR INSTRUCTIONS FOR L&L KILNS

DISPLAY IS NORMAL BUT KILN WON'T HEAT UP

Programming

1) Make sure you have programmed the kiln properly and it is supposed to be firing. Do you have a **Delay Time** or a **Preheat Time** in your program? (Hit the **Review Prog** button on the Easy-Fire or hold down the **Custom/Review** button on the School-Master to find out).

Wiring

1) Unplug kiln or disconnect from live power by turning off circuit breaker or fused disconnect switch. Open panel. Check all power wires for firm connections. Using your multimeter set on resistance you can check continuity of each element circuit by placing the probes on each set of outputs on each Power Relay or right at the Power Terminal Strip (as shown below).

Picture showing a Multimeter testing for continuity in an element circuit.



2) Visually inspect the power wires coming from the Power Terminal Block to the inputs of the Power Relays. Reseat all the spade connectors to rub off any oxides and to ensure a good connection.

EASY-FIRE Control Board Outputs

1) It is possible that the internal switches on the DynaTrol control board could be bad. You can test that by checking to see if you find voltage (12 volts DC) between any of the output contacts on the control board (where the orange, blue and purple wires come out) to ground (any green wire). CAUTION: This test should only be done by an experienced person familiar with electricity and its dangers. See this video: hotkilns.com/check-switches-dynatrol

ONE-TOUCH Control Board Outputs

1) It is possible that the internal switches on the One-Touch™ control board could be bad. You can test that by checking to see if you find voltage (12 volts DC) between

the output contacts (AC1 & AC2 marked on the control board) to ground (any green wire). CAUTION: This test should only be done by an experienced person familiar with electricity and its dangers.

Bad Power Relays

See this video: hotkilns.com/checking-relay and hotkilns.com/change-relay

1) You should be able to hear contactors going on and off with a soft clicking noise when you first turn on the kiln and it is supposed to be heating up. If not try turning the kiln off and then back on again and restarting the program. Of course if you don't hear the relays it only tells you that they aren't firing. The problem could be in the control for instance not telling the relays to fire. If you do hear relays and the kiln is not heating then you know the problem is in the power circuit AFTER the relays.

2) With power on and panel open check voltage before and after each of the contactors while the kiln is firing. CAUTION: This test should only be done by an experienced person familiar with electricity and its dangers.

Bad Elements

See next section.

Run a Simple Paper Test

This will tell you if all kiln sections are firing. If they are not it could be a bad relay or maybe a bad internal switch on the control.

1. Place a little piece of paper in each element.
2. Then run a Fast Glaze (or turn the manual switches to Hi on a manual kiln) while you watch the papers.
3. They begin to smolder in about 2 minutes. After 3 or 4 minutes shut the kiln off.
4. This shows you if the elements are operating (or which ones are and which ones are not).

KILN FIRES UNEVENLY

Peepholes

1) Plug up Peephole holes in the kiln to prevent drafts.

Lid Seal

1) Check to make sure that door/lid is sealing properly. If door/lid is not sealing against top brick correctly a bright red glow will be visible around the door/lid seal when kiln is operating. (A little of this is OK). Also excessive heat loss can be felt around seal. Rub seal high points down with

TROUBLESHOOTING AND REPAIR INSTRUCTIONS FOR L&L KILNS

sandpaper until no more than 1/16 of an inch gap is found at any point along seal. Note that the gap at the top will definitely appear larger than any gap you see between the kiln sections. This is partly because the lid actually bows down in the center of the lid when it heats up and the edges consequently rise slightly. Just check for an UNEVENNESS in this gap which will cause an excessive heat loss.

2) If door/lid is excessively cracked or worn or has holes in it this may cause drafts in the kiln. Replace lid.

See the TROUBLESHOOTING AND FIXING BRICK PROBLEMS section in the TROUBLESHOOTING tab of your instruction manual or hotkilns.com/brick-troubleshooting

Elements

1) Elements may have differentially changed in resistance which will also have an effect on uniformity. The three zone control mostly compensates for this but there are limits. Check element resistance (see section at end of this Troubleshooting Guide called "CHECKING ELEMENT OHMS").

2) Empty the kiln. Then turn kiln on using a fast program like FAST GLAZE until elements are red. Open the door carefully and observe the elements to see if they all seem to be glowing about the same amount. CAUTION: The power does not turn off when you open the lid. Be careful not to put your hand inside the kiln while it is on. Dangerous electric shock could result if you touch an element.

RUN AN EASY-FIRE DIAGNOSTIC

There is a useful diagnostic program within the DynaTrol on Easy-Fire Kilns. This is handy to use when your kiln is first delivered and set up to make sure it was done properly. It can also be useful in seeing if an element has burned out. To use this diagnostic program enter the following sequence when the display says Idle.

1) Press **OTHER, 4, 4, 3**.

2) Keep pressing **OTHER** to cycle through the menu options until you get to **dIAG** and then press **ENTER**.

3) Open the lid of your kiln. You will see each zone of the kiln turn on for one minute each, starting with zone #1, the top zone. The control will display **Out1**, then **Out2**, then **Out3** as it cycles through this sequence. **CAUTION: The power does not turn off when you open the lid. Be careful not to put your hand inside the kiln while it is on. Dangerous electric shock could result.** This will tell you if the kiln sections are in the wrong order or if the wires are somehow crossed in the control panel. If this is the case the zones will not turn on in the proper 1, 2, 3, order.

Loading

The Dynamic Zone Control of the EASY-FIRE kilns can compensate for many uneven loading situations. The SCHOOL-MASTER kilns, however, do not employ Zone Control so pay particularly close attention to the following steps.

1) If you are having a problem with uneven firing try to vary the way you load it to match the firing characteristics of the kiln. For instance if it typically fires hot at the top then put more weight in the top to absorb that heat. You can discern how your kiln fires in each section by using cones.

2) Be sure to put posts under the bottom shelf. The bottom shelf should be at least 1/2" to 1-1/2" above the floor of the kiln.

Firing with Cones

1) Run an empty kiln with three cone packs top- middle - bottom. This will tell you if the load contributes to the problem.

2) Try using cone packs in all sections (top, center, bottom) of the kiln during loaded firings and keep records of what happens. See the TROUBLESHOOTING KILN FIRING WITH CONE PACKS in the LOG, CONES, TIPS, CERAMIC PROCESS tab or hotkilns.com/troubleshooting-cones.

EASY-FIRE Thermocouple Offsets

Thermocouples can drift in their accuracy over time and this can happen at different rates for each thermocouple. If one thermocouple reads at a different temperature than another thermocouple this can cause unevenness in the kiln. You may need to adjust the offsets to trick the kiln into firing hotter or cooler in certain zones. Read about Thermocouple Offset in section 9.9 of the DYNATROL 700 INSTRUCTIONS FOR L&L KILNS in the CONTROL section of the Instruction Manual and the and the CALIBRATING THE CONTROL section in the BASIC OPERATION OF L&L KILNS WITH A DYNATROL 700 in the OPERATION section of the manual. Also see this: hotkilns.com/calibrating-kiln.

ONE-TOUCH Thermocouple Offsets

Thermocouples can drift in their accuracy over time and this can cause inaccurate firings in the kiln. You may need to adjust the offset to trick the kiln into firing hotter or cooler. Read about THERMOCOUPLE OFFSET in the OPTIONS Section of the OPERATION OF L&L KILNS WITH A ONE-TOUCH™ (Deg F) in the OPERATION tab in your instruction manual. Also see this: hotkilns.com/calibrating-kiln.

TROUBLESHOOTING AND REPAIR INSTRUCTIONS FOR L&L KILNS

Vent System

1) Is your vent system on and pulling air? You can check this with a source of smoke in a cold kiln. (If you burn a small piece of paper near the holes on the bottom of the kiln with the vent on and THE KILN OFF you can see if the smoke is being drawn into the holes. You can also check this by feeling the output of the vent when the kiln is at high temperatures. The air coming out should be quite warm to the touch (about 110°F to 140°F). The Vent-Sure will aid in keeping your kiln uniform by drawing hot air from the top of the kiln towards the bottom. It counteracts the natural rising of the heat.

2) If you want to increase draw first close the Bypass valve on the Bypass Collection Box under the kiln. You can also increase the size of the vent holes in the bottom of the kiln. You can also try taking out the top peephole plug. See the L&L VENT-SURE DOWNDRAFT KILN VENT INSTRUCTIONS in the VENT section of your instruction manual or hotkilns.com/vent-sure-instructions.

KILN FIRES TOO HOT OR COLD

Firing with Cones

Try using cone packs in all sections (top, center, bottom) of the kiln and keep records of what happens. See the TROUBLESHOOTING KILN FIRING WITH CONE PACKS in the LOG, CONES,TIPS, CERAMIC PROCESS tab or hotkilns.com/troubleshooting-cones.

Easy-Fire vs Vary-Fire (on DynaTrol)

Keep in mind that the Easy-Fire programs feature Orton software that adjusts the final temperature based on the speed of firing. This in effect adjusts the heat-work and hence the actual cone that the kiln fires to. This applies to Easy-Fire and cone-fire Vary-Fire programs.

Be Careful with Hold Times

Be very careful with hold times. Even a fairly short hold time of 10 minutes can dramatically increase the amount of heat work and hence the cone that the kiln fires to. On the other hand you can use the hold time to increase the heat-work to compensate for underfired work. Just test this in small increments.

Control Settings

1) The ceramic thermocouple protection tubes introduce a known error into the system. This is covered in the Operational Instructions but bears repeating here. The temperature that is measured by the tip of the thermocouple

is approximately 18 Deg F cooler than the actual kiln temperature. We have found through extensive testing that the best way to compensate for this is to put in a Thermocouple Offset of + 18 Deg on each thermocouple. The specific setting is **0018** on Easy-Fire kilns, along with a Cone Offset of **-20** (setting is **9020**) for EACH cone that you fire to on the Easy-Fire Programs (or **9030** on cones 022 to 017).

2) We have already programmed the control with this information so that you don't have to do it. However, we also provide step-by-step instructions on how to do it in BASIC OPERATION OF L&L KILNS WITH A DYNATROL 700 in the OPERATION tab of your manual (or hotkilns.com/basic-operation-dynatrol) and the OPERATION OF L&L KILNS WITH A ONE-TOUCH™ (Deg F) in the OPERATION tab of the School-Master instruction manual (or hotkilns.com/basic-one-touch-f) If you are using the VARY-FIRE programming on an Easy-Fire kiln then use a Thermocouple Offset of plus 70 (setting is **0070**).

Thermocouple Drift

Thermocouples drift in their accuracy with time. You may have to make further adjustments in the Thermocouple Offset or Cone Offset settings over time. **You should change all thermocouples when you change elements because they age at approximately the same rate.**

KILN STALLS

1) The kiln may refuse to increase in temperature, and the kiln will just run on and on. If it is re-started it may work fine for a while. The most likely cause is old or failing elements or relays. An issue in one circuit/section/zone can cause the whole kiln to stall as it waits for the problem section to "catch up". Check the temperatures in all zones to see if one zone is lagging behind and test elements and relays.

2) Thermocouples close to end of their useful life can cause some of these same problems.

3) Sometimes excessive ambient temperatures (over 125°F) around the control can cause stalling too.

4) Corroded connection points can also cause stalling.

5) Generally you will see the error message **Err1** when this happens.

TROUBLESHOOTING AND REPAIR INSTRUCTIONS FOR L&L KILNS

KILN FIRES SLOWLY - BOTH SERIES

Run a Simple Paper Test

This will tell you if all kiln sections are firing. If they are not it could be a bad relay or maybe a bad internal switch on the control.

1. Place a little piece of paper in each element.
2. Then run a Fast Glaze (or turn the manual switches to Hi on a manual kiln) while you watch the papers.
3. They begin to smolder in about 2 minutes. After 3 or 4 minutes shut the kiln off.
4. This shows you if the elements are operating (or which ones are and which ones are not).

Bad or Wrong Voltage

1) Check your voltage. Do this at the kiln at the Power Terminal Block with the control panel open or check it at your fused disconnect box. **CAUTION: This test should only be done by an experienced person familiar with electricity and its dangers.** You need to see what the voltage is when the kiln is firing. Low voltage will make the kiln fire considerably slower. For instance a kiln designed for 240 volts will have 25% less power when operated on 208 volts. Check voltage at your panel and where the kiln is connected. Check the voltage when the kiln is firing and when it is not firing. Sometimes the high amperage draw of the kiln will cause a voltage drop at the kiln. A voltage drop of 5 to 10 volts is not uncommon and is to be expected. If your voltage drop is more than that then you may have a problem with your electrical supply.

2) Make sure no other large electrical appliances such as a clothes dryer or electric oven are on when you are operating your kiln. This may cause a voltage drop which would slow the kiln down.

3) Voltage may vary in your area depending on season and time of day. Frequently there are "brown outs" during the summer months in some areas. This is when the electric utility reduces the voltage. Try firing at night after peak electrical use hours. You can use your Delay feature to do this easily. Find out from your local utility company when the end of the peak period of electrical use is. Some utilities offer preferential rates for using electricity at night because it is cheaper for them.

4) Check to see what the wire size of your circuit is. If it is very long (more than 50 feet) from your main circuit box then the wire size might need to be higher (e.g. #8 instead of #10 wire).

Element Aging

1) Elements both age and increase in resistance when fired. When they increase in resistance the amount of power they develop decreases. See the section on "CHECKING ELEMENT RESISTANCE" at the end of this guide.

2) Replacing only one element per section or zone may cause an unbalance in firing. In Easy-Fire kilns the multi-zone control will compensate for much of this imbalance automatically, however, this will not be the case in School-Master kilns.

3) Use original L&L parts for satisfactory maintenance. (Elements, in particular, provided by other vendors may not work well in your L&L kiln. Some of our customers have found this out the hard way and thought it was an L&L problem. Only L&L has the design information to make our elements properly).

4) Empty the kiln. Then turn kiln on until elements are red. Open the door carefully and observe the elements to see if they all seem to be glowing about the same amount. **CAUTION:** The power does not turn off when you open the lid. Be careful not to put your hand inside the kiln while it is on. Dangerous electric shock could result. See the diagnostic program described in the earlier section called KILN FIRES UNEVENLY.

5) Elements expand and grow with age. If you fire low-fire clay and glazes and never get above cone 05 or so, your elements will last a long time, especially if you are only bisque firing. This is good, to a point. If you only low-fire, the problem you are most likely to encounter over many years is that the elements will expand as they age. The length and the coil diameter increase. Meanwhile the atmosphere in the kiln slowly eats away at the metal of the element. Although the total resistance usually increases as the elements age, sometimes it decreases, or reverses itself. This usually only happens when the elements are very old but have not yet failed completely. As the element expands, it binds up in the corners. This can make the individual coils push together and touch each other in the corners, making a short cut for the electricity, reducing the amount of element material the electricity must pass through, and therefore reducing the resistance in the whole element. This may make it hotter in the kiln, but if there is a lot of element material jammed in the corners there will not be enough material left in the coiled form to radiate the heat generated by the increased amperage and decreased resistance. Only the parts of the wire not touching the coils on either side of them will emit heat. More amperage through the electrical components in the control could cause damage if the situation continues or

TROUBLESHOOTING AND REPAIR INSTRUCTIONS FOR L&L KILNS

the resistance drops far enough. In addition, the expanding diameter of an element can make it difficult to get it out of the holder. Usually this will not happen to those firing to higher temperatures because the maximum temperature of the kiln is quickly compromised by increases in the resistance, requiring the elements to be changed long before they can jam up in the corners. Also, high temperatures and glaze firings are more prone to eating through the element, causing it to fail, before the element can expand enough to cause the problems mentioned above. Visually inspect your elements for the above conditions and do a resistance check. If you see this it may be time to change elements.

Power Relays

As mechanical switches, power relays will fail over time. In particular, the coil which actuates the switch closure increases in resistance to the point where it no longer has the power to close, especially as it gets hot. This means that a relay can work at low temps but fail at elevated ones, making it more difficult to diagnose.

WIRES WILL GET HOT

Unlike many other appliances that use electricity (like motors) kilns are called a "resistive load." This means that there will be a continuous pull of steady electrical power for many hours. Even with properly sized wire this will generate SOME heat in the wires. This is one reason we recommend against using aluminum wire for a power feed. If you look carefully you will see that we have OVERSIZED our internal power wires far in excess of their rated capacity. In addition all our power wire is rated for very high temperatures. The larger the wires the less resistance in the wires and the cooler they will operate.

Bad Wiring

1) Have an electrician check your wiring. We have seen aluminum wire cause intermittent problems with allowing enough voltage through. We do not recommend aluminum wiring although some electricians will swear by it. The problem with it is that aluminum oxide, which is formed from heat, is a resistor while copper oxide is not a resistor. With kilns you will often develop some heat in the electrical lines. If all connections are perfect and the wire is oversized you probably will not have a problem - but why take that chance? Make sure your wires are of the proper size and that all connections are good.

2) Check your circuit breaker for proper operation. These sometimes go bad over time.

3) If all the elements are firing and the kiln is still firing too

slow check the amperage draw of the kiln under a full load. CAUTION: This test should only be done by an experienced person familiar with electricity and its dangers. You need to see what the voltage is when the kiln is firing.

Check amperage under load with an amp-probe.



3) To check to see if all zones are firing on an Easy-Fire kiln, press the number 8 on the control numeric pad. You will see one little light per zone under the numbers on the control display. If you see two dots on an e18S, e23S, or e28S then you are firing at full load. If you see three dots on an e18T, e23T, or e28T then you are firing at full load. See if the amperage drawn is the same as what the kiln is rated for. See the product literature and/or data nameplate on the kiln for the rated amperage draw. There is also a complete table of this information in the Installation Instructions part of this manual. For instance, a model e23T rated for 240 volts, Single Phase should draw 48.0 amps. If it is substantially less than the rated amperage draw and your voltage is within 5% of the rated voltage (for instance 230 volts for a 240 volt unit), then chances are the elements have changed in resistance. This will require element replacement.

Pressing the number "8" will turn on 2 or 3 small LEDs that indicate whether the various zones are firing.

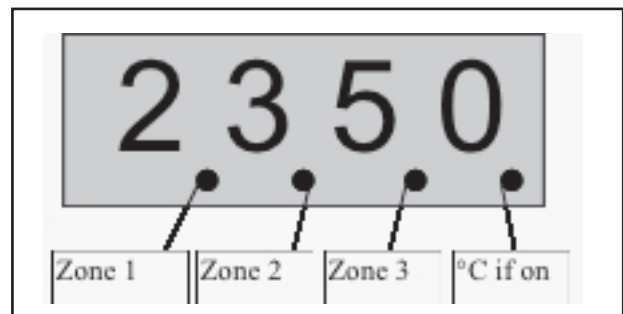

Wiring in the Kiln

1) Unplug kiln.

TROUBLESHOOTING AND REPAIR INSTRUCTIONS FOR L&L KILNS

- 2) Trace wiring for missing or bad connections.
- 3) Check wiring against wiring diagram.
- 4) Check for corroded connectors or connectors that have frayed wires. Replace if you see this.

Element Connections

1) The holes where the elements go through the firebrick walls are too large. This could cause too much heat to escape from the kiln thereby overheating the element terminals. This can be remedied by lightly stuffing non-RCF ceramic fiber in the element holes. (See hotkilns.com/non-rcf-fiber-blanket for non-RCF fiber). You can stuff this in from the inside of the kiln using a sharp tool like a very small screw driver.

2) Check to see if the element ends are twisted properly. They should be twisted clockwise around the terminal screw. If the twist is too loose this could generate extra heat at the element ends. Check for corrosion on the terminal. If there is corrosion sometimes you can remove it with a wire brush.

3) The element connection hardware may not be tight enough. A loose connection can generate heat and cause oxidation of the hardware which in turn will cause a worse electrical connection (because of resistance) and more heat. Replace with new terminal hardware. See hotkilns.com/parts and filter for **Model Series** and **Elements (Terminals)**

Heat Leakage & Vents

- 1) Make sure peephole plugs are in.
- 2) Make sure hole for vent is proper. Check Vent-Sure instructions for proper hole sizes.
- 3) If you are using a different brand of vent make sure it is the appropriate size for your kiln. Check with the vent manufacturer and tell them how many cubic feet are in your kiln.
- 4) If your lid or bottom is cracked check to see if it seems to be leaking much heat at high temperatures. Patch or replace if extreme. (SOME IS OK).

Adding More Insulation

- 1) In L&L's top loading kilns an additional bottom may be placed under the original bottom. This will improve the insulation in the kiln, thereby slowing heat loss and speeding the firing time. You can also put a 2" layer of calcium silicate on top of the stand beneath the bottom of the kiln.
- 2) Also try raising the height of the kiln from the floor or putting a reflective stainless steel or aluminum sheet under

the kiln. All these things keep the floor from absorbing the radiant energy from the kiln and will improve heat up times (as well as bottom of the kiln uniformity).

3) Put a 1" layer of non-RCF ceramic fiber on the lid. This is completely non-hazardous which is important in this application because you will be releasing fibers into the air when you move it while loading. While this is a somewhat extreme measure we have found that a disproportionate amount of the heat loss from a kiln is through the top. Non-RCF ceramic fiber is soluble in the body and is considered totally safe.

4) Whatever you do be sure NOT to put the kiln directly on the floor. If the floor is cement or other hard non-flammable material it will absorb the heat from the kiln. If the floor is wood or other flammable material you will create a very DANGEROUS situation which could cause a serious fire.

KILN FIRES SLOWLY - EASY-FIRE

Single vs Three Zone Control

1) Three zone control will slow a kiln down. It helps even out the temperatures in a kiln by shutting off one or more zones while firing. In addition zone control introduces other issues like LAG that sometimes complicate a firing. The first thing to try if you are getting a slow firing is to switch the kiln to single zone operation. That may get you back into operation quickly. Then, if that makes the problem go away you can fine tune the specific issue within the zone system that is causing the problem.

2) Normally models e23S and e28S are programmed to have two zones and models e23T and e28T are programmed to have three zone control. You can easily change this to be single zone operation.

3) Press **OTHER, 4, 4, 3**

4) The display says **notC** This stands for "number of thermocouples".

5) To run the kiln using only one thermocouple press **ENTER** at the **notC** prompt. You will then see **0003** or **0002** (depending on whether it is currently programmed for three zones or two zones). Then press **1**, then **ENTER**. The display will then say **StOP**. All the zones of the kiln will turn on and off simultaneously when you program the DynaTrol to use only one thermocouple.

TROUBLESHOOTING AND REPAIR INSTRUCTIONS FOR L&L KILNS

ShtO (SHUT-OFF) SETTING

- 1) This option is used to shut off the automatic feature in the DynaTrol that holds the hottest part of the kiln at each segment's set point until the average of the three (or two) thermocouples reaches that set point. This can have a dramatic effect on speed of firing and is worth trying to see if it helps you if you are having a problem.
- 2) When you press **OTHER, 4, 4, 3**.
- 3) Press **OTHER** until **ShtO** is displayed.
- 4) Pressing **ENTER** here allows you to toggle, using any number key, between **On** and **OFF**.
- 5) **On** means that as soon as the hottest zone gets to the segment's set point the entire kiln switches to either the "hold time" or the next segment. This will result in a quicker firing.
- 6) **OFF** means that the DynaTrol will not let the hottest zone's temperature rise until the average temperature of the three zones reaches that segment's set point. Then the kiln can begin the "hold time" or the next segment. This will result in more even firing.
- 7) When you have the setting you want shown in the display (On or **OFF**) press **ENTER**. **CPL** will display for a few seconds and then **Idle**, **tC2** and current temperature.

PId SETTING

- 1) This setting generally should be left at its factory default because it is hard to predict the changes that it will create in your firing. However, a full explanation is given for more advanced users who want to experiment with this.
- 2) This setting comes pre-programmed at the factory for 65%. Basically this setting determines how much help the middle zone of the kiln gives the bottom zone of the kiln when the bottom zone is lagging behind during heating. This comes into play when the bottom zone is on 100% of the time. With this feature, the middle zone of the kiln will come on the programmed percent (**PId**) of the time that the TOP zone comes on, if the bottom zone is on all the time. Tests showed that if the bottom was on 100% of the time, the top zone was generally on 90% of the time, but the middle zone was on only about 40% of the time. By programming a higher percent you can greatly speed up your firings. (you will have to experiment, try the factory setting 65% then try maybe 100% and compare your results). Basically the higher the **PId** setting the faster the firing at the potential price of unevenness.
- 3) As your elements age firing by firing, this setting will activate earlier and earlier in the firing because the bottom

will be working at 100% earlier and earlier. This will allow the artificial inflation of the center's temperature sooner and sooner. Because this center is heating based on mathematics now and not it's own thermocouple's reading, it will have a longer and longer period of time to get hotter than the top and the bottom. In some cases this can lead to gross unevenness. You may find yourself dialing down the **PId** to something like 50% or 60%. Remember that if it is set around 40% (it's normal operating percentage) or below, the thermocouple's reading then will be the control for that section, not the mathematics of the **PId** feature.

- 4) When display flashes **IDLe**, **tC2** press **OTHER** see **rSEt**. Press **4, 4, 3**. See **notC**
- 5) Keep pressing **OTHER** to cycle through the menu options until you get to **PId**.
- 6) Press **ENTER**. See **Pct**, **00&5** cycling.
- 7) Press any number from **0** to **150**, see the number you have entered preceded by a zero like **0120** if you entered **120**. Press **ENTER**, see **CPL** or **StOP** for a few seconds, then **IDLE**, etc.
- 8) Pressing **ENTER** here allows you set another percent setting that can help a slow, heavily loaded kiln fire faster.

Change elements to graded elements.

This is an extreme solution for Easy-fire kilns but can be effective. Contact factory.

KILN HEATS TOO FAST

Relays

- 1) A stuck relay, meaning that the power relay is stuck closed, delivering constant power to the elements, can cause the kiln to heat uncontrolled. If the kiln is still heating even when no program is firing or even the toggle switch is off, then you have a stuck relay. Whichever section is still heating, that is the relay that needs replacing.

Voltage

- 1) Check your voltage. Some people may have high voltage like 245 volts where you should nominally have 240 volts.
- 2) Make sure you don't have a 208 volt kiln hooked up to a 240 volt circuit. This is dangerous because the kiln will draw more amps than it is rated for which will overload the power wires and other components and could cause a fire.

Elements

- 1) Check element ohms and compare with factory values. (See CHECKING ELEMENT OHMS later in this section).

TROUBLESHOOTING AND REPAIR INSTRUCTIONS FOR L&L KILNS

2.) Make sure the elements are wired properly. Check the wiring diagram.

EASY-FIRE ERROR MESSAGES

See this for a complete description on the web: hotkilns.com/error-codes. You can also see more information in the instruction manual in the CONTROL section: Appendix E in DYNATROL 700 INSTRUCTIONS FOR L&L KILNS.

Error codes can appear at any time during the firing. They always refer to a problem that, if allowed to continue, could end with unknown or even disastrous results. **Errd**, **Err1**, **ErrP** and the **FAIL** message make the most frequent appearances. **Errd** means there is a temperature difference of more than 50 degrees between the zones. **Err1** indicates that the kiln is climbing too slowly in an Easy-Fire program. **ErrP** indicates that there was either a very quick power outage (**ErrP** will flash along with the temperature and the kiln will still be heating), or there was a longer power outage (**PF** will be the only thing in the display and the kiln will not be heating). **FAIL** refers to a specific thermocouple failure. It will appear after displaying a 'tC' (thermocouple) number 1, 2 or 3.

Errd

1) If the kiln was just re-assembled and **Errd** is the error code, then double-check that the element connection wires go to their proper power relays and that the thermocouple wires are connected to the proper zones.

2) If you are sure the kiln is set up properly, nothing is out of place and none of the thermocouples are partially out of the kiln, then one of the following situations may apply:

3) You were firing with the lid open and you got **Errd** either while the lid was open or right after you closed it. For drying with the lid open, only about two inches is needed to adequately vent off water vapor. This is plenty if all the peep holes are open. The DynaTrol will attempt to compensate for the heat loss, and it usually can. The trouble may happen when you close the lid. The elements in the top of the kiln are already much hotter than the ones nearer the bottom due to their need to compensate for the heat loss from the top. When you close the lid it can take as long as eight seconds for the DynaTrol to respond to the rise in temperature in the top of the kiln, and shut off those elements. This can quickly cause an uneven temperature in the kiln, which will usually result in **Errd** (possibly an **Err2** in a smaller kiln -**Err2** is when the entire kiln temperature is more than 50°F over the hold time's temperature for longer than 18 seconds).

4) There was a lot of air being exhausted from your kiln when **Errd** appeared. If a vent system pulls too much air from just one point in the kiln, say, to down-ramp the load very quickly to a lower hold time for crystal formation, an uneven temperature can result. The firing will go slowly as it will be difficult to compensate for the heat loss; eventually, however, the **Errd** (or **Err1**) can appear.

5) Something is too close to, or is touching, **TC#** in the kiln. Allow almost an inch between everything for thermal expansion. Fix and re-fire the kiln.

6) A thermocouple wire has melted against the kiln case. The wire must be replaced.

7) A thermocouple is about to fail. Perform a physical inspection if possible, or just re-start the kiln and monitor it carefully.

8) Element(s) just burned out. Perform an ohms test for more information.

9) A relay has just failed. Perform a voltage test.

10) There is a bad connection point somewhere. This will become more of a possibility as the kiln ages. Examine all points carefully for melting, corrosion, and discoloration.

Err1

1) If **Err1** is the error code on the screen when you check on the firing, then for some reason the kiln could not generate enough heat to counter the heat loss. If the kiln can get no hotter (even though all the elements appear to be on and the program is not holding), then **Err1** is what you will see. If one of the elements or one of the circuits in the control fails while the kiln is at a high enough temperature then it will probably display an **ErrB** code (which means temperature is falling when it should be rising) **Err1** or **ErrB** can mean either you need new elements or a new component in one of the circuits. An ohms test and a voltage test can tell you which it is. If you recently changed locations, power supplies, elements, or did any repairs, then closely examine what changed between your last successful firing and this one. There may be some other issue besides bad elements or a bad component.

2) A new location can mean a 208 volt power supply rather than a 240 volt supply (about 25% less power).

3) In re-wiring the power supply you may not have used thick enough copper wire (line, conduit and connection points will be very hot).

4) The elements are the wrong resistance. Check new elements with your multimeter just to be safe. Mistakes can happen.

TROUBLESHOOTING AND REPAIR INSTRUCTIONS FOR L&L KILNS

5) If you rewire anything improperly or incorrectly the potential for anything from a blown breaker to just no power at all is possible. (Using wire with a temperature rating of less than 150°C for the power wiring can seriously limit the life of the circuitry and can be dangerous as well, especially when the wires are close to the kiln.) Use a wire diagram and trace every wire to check yourself. You can buy high temperature wire from L&L (see the Parts List).

Err2

During a hold segment the temperature rises to greater than 50 degrees above the hold temperature which was set. The temperature must stay 50 degrees above this set temperature for 18 seconds before the error is displayed.

Err3

During a hold segment the temperature is more than 50 degrees below the hold temperature which was set. The temperature must stay 50 degrees below this set temperature for 18 seconds before the error is displayed.

Err4

The temperature is more than 50 degrees above the previous hold temperature during a ramp segment where the temperature is programmed to decrease. The temperature must stay 50 degrees above this set temperature for 18 seconds before the error is displayed.

Err5

The temperature is more than 50 degrees below the local setpoint temperature during a ramp segment where the temperature is programmed to decrease. The temperature must stay 50 degrees below this set temperature for 18 seconds before the error is displayed.

Err6

A Negative temperature is displayed. This generally indicates the thermocouple is connected incorrectly. To correct this situation, ensure the red and yellow wires are connected correctly to the controller and at all junctions. You can identify the red lead on an unmarked thermocouple with a magnet because a magnet will be attracted to the red lead.

Err7

The temperature is more than 50 degrees above the local setpoint temperature during a ramp segment where the temperature is programmed to increase. The temperature must stay 50 degrees above this set temperature for 18 seconds before the error is displayed.

Err8

When using the Easy Fire Mode, the temperature is decreasing during the last ramp segment. This could indicate that the lid was up or the peepholes open or some other physical thing is causing the kiln to decrease in temperature.

ErrP + PF

Continuous **PF** in display. Indicates a long term power outage. The kiln has been shut down. Press **1** to clear the display.

ErrP and the current temperature are alternately flashing. To clear the display, press the **1** key. If a firing was in progress, the kiln will continue to fire even though this message is flashing. This error can also happen as a result of RF (radio frequency) noise that resets the microprocessor. If this is suspected, the control panel should be returned to L&L for testing and possible modification. Also see hotkilns.com/noise

Err-

The **Err** with a dash indicates there was a power loss to the controller while writing a program to the non-volatile memory chip. Recheck the selected program, and reprogram if necessary.

FAIL

1) If, upon inspection, the error code **FAIL** turns out to be a burned out thermocouple then replace it. You typically will not need to replace the mullite protection tube - just the internal thermocouple "element" (see hotkilns.com/thermocouple-k-standard). You should not mix unsheathed thermocouples with sheathed ones. (because their response rates are slightly different). A spare on hand is a good idea as well.

2) If the TCs are not bad (you just replaced them and they worked fine for at least one complete firing) but the **FAIL** message still appears, it may be that the TC wire is bad (melted or broken at a point) or the electronics have partially failed.

A) Turn OFF the power at the Disconnect Switch or Circuit Breaker and/or unplug the kiln.

B) Open the cover of the control.

C) Remove the Thermocouple wires from the DynaTrol and the Thermocouple Terminal Strip. Take out of the Control Box and set aside.

D) Make tiny "U" shaped jumper wires from paperclips and jumper between each of the + and - connections on the

TROUBLESHOOTING AND REPAIR INSTRUCTIONS FOR L&L KILNS

DynaTrol board.

E) You are simply completing each TC circuit without using the TC wire or the TC. Do not let the 'U's touch anything other than the TC connection points. Note: the fact that a paperclip is not the proper type of metal to use in a Type K TC circuit is not an issue for a test like this.

F) Close up the Control Box and turn the unit on. If it still says **FAIL** then the electronic board has failed. If it reads room temperature then the TC wire or the TC has failed.

G) If it reads room temperature with these jumpers in, and you are not sure if it is the TC or the TC wire, just re-attach TC2's wire to TC3 and re-attach TC3's wire to TC2. If the **FAIL** message is still on **TC2** then it is the wire, not the TC. If it says that the **FAIL** is now at **TC3**, then you know it is the TC, not the wire (there are many other ways to determine this as well).

Turning Error Codes On or Off

1) When you receive your DynaTrol the error codes are turned on. In most cases, you will want the error codes on. They can be turned off if you are doing special firings, such as jewelry or glass firing where the kiln is opened while hot. Turning the error codes off turns off the dynamic zone control feature that keeps the temperature in the kiln even top to bottom. It eliminates nuisance shut downs but side steps built in fail-safe measures.

2) The only Error codes that this can not turn off are **ErrB**, **FAIL**, and **ErrP** in both the "Easy Fire" and "Vary Fire" modes. In addition **Err1** and **ErrB** are not turned off in the last segment of an "Easy Fire" program. This is because the built in calculations would make no sense if the kiln were firing too slowly.

3) To turn Error Codes off do the following:

4) Press the **OTHER** button several times until you see **ErCd**.

5) Press **ENTER**

6) Display will say **On** (which indicates that the error codes are turned on) or **OFF** (which indicates that the Error Codes are Off). You can toggle back and forth between on and off by pressing the **1** key.

7) Hit **ENTER** when you see **On** or **OFF** and you want to keep that setting

8) **CPL** will display for a few seconds. **IdLE**, **tC2**, and the current temperature then cycle in the display.

Can you restart the kiln after it stops because of Error Codes?

You can try to restart the kiln after getting an error code. Some messages, like flashing **ErrP** and **FAIL**, will not necessarily turn off the kiln. Depending on the problem though, re-starting it may or may not let it finish the firing, or even start up again. An **Errd** will usually not re-start easily because the temperature top to bottom is drastically different. An **Err1** at the end of the firing will re-start but will probably re-occur in about 22 minutes. A **FAIL** message will not go away even if the problem is fixed during the firing. The kiln can still be firing with the **FAIL** message flashing along with the number of the TC that failed. Stopping and then re-starting the kiln after fixing the problem with the TC circuit is the only way to erase the **FAIL** message. **ErrP** flashing with the temperature means that the kiln is still firing, after just a short power outage or interference. Just press any number to clear the **ErrP**. An **ErrP** which is not flashing must be re-started.

Worst Case Scenario for Restarting After an Error Code

Keep in mind that you run the risk of over-firing if you re-start while the kiln is very close to the final temperature. A pyrometric cone melts with the proper combination of time and temperature. Add more time and you don't need as high a temperature, go to a higher temperature and you don't need as much time. When an error code shuts down the kiln near your final temperature (within about 50 degrees) and you do not know exactly how long it has been cooling, or what temperature it reached before the error code appeared, you run the risk of having too much unaccounted for time in your time-temperature equation. The DynaTrol calculates this equation automatically after determining how many degrees per hour the kiln is climbing (time) and to what temperature it is climbing to (temperature). However, it cannot do this accurately after a high temperature re-start.

If you have cones in the kiln that you can see through the peepholes, then use these after you re-start and turn off the kiln manually when the target cone bends over.

If you do not have cones visible then you can gamble and estimate a final temperature based on how many degrees per hour the kiln has risen, including the time it was off.

For example, you come in and the control says **tC2**, **2200** (degrees F) and everything seems fine in your slow glaze to cone 6 firing. But twenty-five minutes later you come back and see **Err1**.

The first thing you want to do is press 1 to clear the error

TROUBLESHOOTING AND REPAIR INSTRUCTIONS FOR L&L KILNS

code. Look for tC2's temperature and write it down. It might be 2175. You have no cones in the kiln but you really need these pieces fired.

Wait a few seconds until you see "IDLE, tC2, 2175". Press **START** to re-start the program and note the time on your watch. Note the 25 minutes the kiln was "holding" from the last time you saw it at 2200°F until this time, where it says 2175. It must have continued to climb somewhat, but because the Err1 will appear after 22.5 minutes of holding when the kiln is programmed to be climbing, it probably never got over 2210°F. So the kiln has held at an average of about 2195°F for about 25 minutes, instead of continuing on to 2232°F (cone 6) to finish the firing.

The relationship between time and temperature allows you to estimate how much hold time to add to get the same amount of heat work as the kiln would have achieved by climbing to 2232°F. Assuming a 108°F per hour temperature rise, a good rule of thumb is to add about a 20 minute hold to the maximum temperature; this will allow you to lower the final temperature by about 20°F. An hour hold time would mean a final temperature of about 40°F lower. A two hour hold time would be about 60°F lower.

In this example, the kiln has already held at about 35 degrees lower than the final temperature for 25 minutes. It would need another 25 minutes of holding to give the ware the same amount of heat work that 2232°F (cone 6) would have.

In reality, however, an Err1 that close to the end of a firing probably means you need new elements. So re-starting the kiln will probably not enable it to climb much higher in temperature. Keeping track of the time, let it run, and when it shows Err1 again just keep re-starting it until the firing finishes. Meanwhile call and order new elements.

Be very careful if you try this method. On loads that are very important always use cones you can see through the peepholes in case of a failure of some kind. If you have to use this method without the cones, remember that almost all your calculations are based on estimates and the results could be disastrous to your ware and/or the kiln if you are not accurate enough. The further away the temperature that the kiln is holding at is from the cone that the firing was trying to get to, the less accurate an estimated amount of time will be to achieve the amount of heat work necessary. If you can wait and re-fire from room temperature, you should. If you depend in any way on your kiln you should keep spare parts around for it. You could replace the elements easily yourself after the kiln cools and then re-load it and re-fire it to the proper cone without losing much time at

all. Or consider that most glazes have an entire cone's temperature range that they can mature within. Weigh your options and decide.

In general though, Error Codes mostly appear after the kiln has been disassembled and set back up improperly, has had its power supply altered (like moving to a new studio with different voltage), or has had an element, a relay, or a thermocouple burn out.

ONE-TOUCH ERROR MESSAGES

Error codes can appear at any time during the firing. They always refer to a problem that, if allowed to continue, could end with unknown or even disastrous results. Errd, Err1, ErrP and the FAIL message make the most frequent appearances.

Errd

Error d indicates that the kiln temperature is 100°F above the traveling set-point, which is the current desired temperature in the kiln. The traveling set-point will increase or decrease according to the programmed rate.

- 1) Something is too close to, or is touching the thermocouple. Allow almost an inch between everything for thermal expansion. Fix and re-fire the kiln.
- 2) The Thermocouple Lead Wire has melted against the kiln case. The wire must be replaced.
- 3) The thermocouple is about to fail. Perform a physical inspection, or just re-start the kiln and monitor it carefully.
- 4) Element(s) just burned out. Perform an ohms test for more information.
- 5) The relay has just failed.
- 6) There is a bad connection point somewhere. This will become more of a possibility as the kiln ages. Examine all points carefully for melting, corrosion, and/or discoloration.

Err1

Error 1 indicates the temperature in the kiln is rising during an up ramp slower than 15°F/hr. If this rate continues for 8 minutes the firing will be stopped. Err1 may be an indication that the elements are worn or that a relay has stopped working.

- 1) If Err1 is the error code on the screen when you check on the firing, then for some reason the kiln could not generate enough heat to counter the heat loss. If the kiln can get no hotter (even though all the elements appear to be on and the program is not holding), then Err1 is

TROUBLESHOOTING AND REPAIR INSTRUCTIONS FOR L&L KILNS

what you will see. **Err1** can mean either you need new elements or a new relay. An ohms test and a voltage test can tell you which it is. If you recently changed locations, power supplies, elements, or did any repairs, then closely examine what changed between your last successful firing and this one. There may be some other issue besides bad elements or a bad component.

2) A new location can mean a 208 volt power supply rather than a 240 volt supply (about 25% less power).

3) In re-wiring the power supply you may not have used thick enough copper wire (line, conduit and connection points will be very hot).

4) The elements are the wrong resistance. Check new elements with your multimeter just to be safe. Mistakes can happen.

5) If you rewire anything improperly or incorrectly the potential for anything from a blown breaker to just no power at all is possible. (Using wire with a temperature rating of less than 150°C for the power wiring can seriously limit the life of the circuitry and can be dangerous as well, especially when the wires are close to the kiln. Use a wire diagram and trace every wire to check yourself). You can buy high temperature wire from L&L (see the Parts List).

ErrP

ErrP is displayed whenever there is a power interruption that is long enough to stop the firing. If the power interruption is brief the kiln will continue to fire when power is restored; in this case there will no indication of a power failure. To clear the error, press any key.

This error can also happen as a result of RF (radio frequency) noise that resets the microprocessor. See hotkilns.com/noise

ErrF

ErrF indicates the temperature in the kiln is decreasing during a down ramp less than 15°F/hr. If this rate continues for 8 minutes the firing will be stopped. **ErrF** may be an indication that a relay has stuck in the on position.

tC-

tC- indicates that the red and yellow thermocouple wires are reversed. Make sure they are right all the way through the circuit.

FAIL

See the section in these Troubleshooting Instructions called DISPLAY READS **FAIL** and **tC**.

Can you restart the kiln after it stops because of Error Codes?

You can try to restart the kiln after getting an error code. Some messages, like flashing **ErrP** and **FAIL**, will not necessarily turn off the kiln. Depending on the problem though, re-starting it may or may not let it finish the firing, or even start up again. An **Err1** at the end of the firing will re-start but will probably re-occur in about 22 minutes.

Worst Case Scenario for Restarting After an Error Code

Keep in mind that you run the risk of over-firing if you re-start while the kiln is very close to the final temperature. A pyrometric cone melts with the proper combination of time and temperature. Add more time and you don't need as high a temperature, go to a higher temperature and you don't need as much time. When an error code shuts down the kiln near your final temperature (within about 50 degrees) and you do not know exactly how long it has been cooling, or what temperature it reached before the error code appeared, you run the risk of having too much unaccounted for time in your time-temperature equation.

If you have cones in the kiln that you can see through the peepholes, then use these after you re-start and turn off the kiln manually when the target cone bends over.

If you do not have cones visible then you can gamble and estimate a final temperature based on how many degrees per hour the kiln has risen, including the time it was off.

For example, you come in and the control says **2200** (degrees F) and everything seems fine in your slow glaze to cone 6 firing. But twenty-five minutes later you come back and see **Err1**.

The first thing you want to do is press **1** to clear the error code. Look for the temperature and write it down. It might be **2175**. You have no cones in the kiln but you really need these pieces fired.

Wait a few seconds until you see "**Idle, 2175**". Press **START** to re-start the program and note the time on your watch. Note the 25 minutes the kiln was "holding" from the last time you saw it at 2200°F until this time, where it says **2175**. It must have continued to climb somewhat, but because the **Err1** will appear after 22.5 minutes of holding when the kiln is programmed to be climbing, it probably never got over 2210°F. So the kiln has held at an average of about 2195°F for about 25 minutes, instead of continuing on to 2232°F (cone 6) to finish the firing.

The relationship between time and temperature allows you to estimate how much hold time to add to get the same

TROUBLESHOOTING AND REPAIR INSTRUCTIONS FOR L&L KILNS

amount of heat work as the kiln would have achieved by climbing to 2232°F. Assuming a 108°F per hour temperature rise, a good rule of thumb is to add about a 20 minute hold to the maximum temperature; this will allow you to lower the final temperature by about 20°F. An hour hold time would mean a final temperature of about 40°F lower. A two hour hold time would be about 60°F lower.

In this example, the kiln has already held at about 35 degrees lower than the final temperature for 25 minutes. It would need another 25 minutes of holding to give the ware the same amount of heat work that 2232°F (cone 6) would have.

In reality, however, an **Error** that close to the end of a firing probably means you need new elements. So re-starting the kiln will probably not enable it to climb much higher in temperature. Keeping track of the time, let it run, and when it shows **Error** again just keep re-starting it until the firing finishes. Meanwhile call and order new elements.

Be very careful if you try this method. On loads that are very important always use cones you can see through the peepholes in case of a failure of some kind. If you have to use this method without the cones, remember that almost all your calculations are based on estimates and the results could be disastrous to your ware and/or the kiln if you are not accurate enough. The further away the temperature that the kiln is holding at is from the cone that the firing was trying to get to, the less accurate an estimated amount of time will be to achieve the amount of heat work necessary. If you can wait and re-fire from room temperature, you should. If you depend in any way on your kiln you should keep spare parts around for it. You could replace the elements easily yourself after the kiln cools and then re-load it and re-fire it to the proper cone without losing much time at all. Or consider that most glazes have an entire cone's temperature range that they can mature within. Weigh your options and decide.

In general though, Error Codes mostly appear after the kiln has been disassembled and set back up improperly, has had its power supply altered (like moving to a new studio with different voltage), or has had an element or a thermocouple burn out.

SERVICE FOR YOUR KILN

WHERE TO GET SERVICE

See the SERVICE Section of your Instruction manual or see hotkilns.com/technical-support

WHERE TO BUY PARTS

You can order parts for your L&L Kiln through L&L or your local distributor. See the Parts List that pertains to your particular kiln model. Our on-line parts list is easy to navigate. See hotkilns.com/parts. Standard Parts are typically shipped the day after an order is placed. Rush service is available.

REPLACEMENT ELEMENTS

Replacement Elements made by L&L Kiln Mfg., Inc. are designed for each individual model for long life and superior performance. Good element design is a complex balance of watt density, design voltage, stretch ratio, wire gauge, element length and material. It takes many hours and years of experience to design a good element for each model. Do not expect an outside supplier with no interest in your kiln performance or long experience with L&L kilns to spend the necessary time to do this right. In the end you will not save

NOTE: Many of these procedures have accompanying instructional videos. Look out for the video links in each section or go to hotkilns.com/videos for more.

REMOVING PANEL FOR SERVICE

- 1) It is easy to access the inside of the control panel for troubleshooting. In addition it is easy to remove this panel and send it back to the factory for inspection and/or repair.
- 2) Disconnect power and unplug the kiln.
- 3) Follow the instructions in ASSEMBLY INSTRUCTIONS FOR in the ASSEMBLY tab of your instruction manual or see hotkilns.com/assemble-easy-school in order to remove the Control Box for Easy-Fire and School-Master kilns.
- 4) Pack the control panel with cushioning material such as bubble wrap, balled-up newspaper or foam in a cardboard box and follow instructions from the factory or your local distributor about where to send it. **DO NOT SEND A CONTROL PANEL WITHOUT CALLING FIRST.**

CAUTION: The controller contains electronic components which are sensitive to static electricity. Before handling the controller dissipate any static charge you may have by touching metal or a screw on the controller panel, the electrical box, the kiln lid, or some other grounded object.

TROUBLESHOOTING AND REPAIR INSTRUCTIONS FOR L&L KILNS

REPLACING DYNATROL

See this video: hotkilns.com/replace-dynatrol

- 1) Unplug kiln or turn off the kiln at the fused disconnect switch.
- 2) Remove the four #6 screws that hold the DynaTrol in place from the front face of the control panel.
- 3) Open up the control box and hinge down for access (as shown on page 2)
- 4) Pull off the spade connectors from all the connection points on the back of the control. Loosen the screws that hold down the thermocouple wires and pull out the wires from under the screw heads. It is OK to remove the screws if this is easier for you. First note where all the wires go. These are all clearly marked with color coding on the Wiring Diagram.
- 5) Pull old control out. Put new control in and screw in place with the #6 mounting screws. Replace wires on proper connectors.
- 6) Be careful to get the Red or Yellow of the thermocouple wires to match the colors painted on the DynaTrol board.

Picture showing thermocouple wires installed on DynaTrol. There is no need to wrap the thermocouple wire around the screw head- although it is OK to do so. However, do make sure the wire is tight and secure UNDER the screw head.

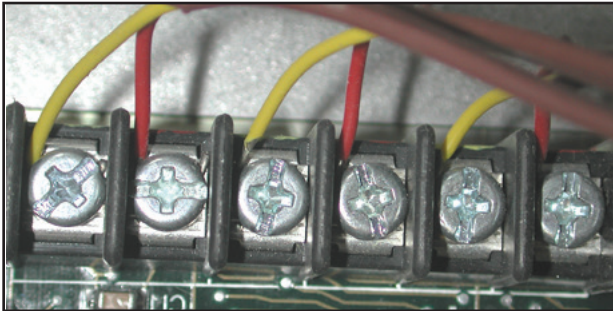

- 7) Double check that the proper color coded wire goes to the proper terminal.

Orange = OUT 1

Blue = OUT 2

Purple = OUT 3 (not on e18S, e23S, and e28S)

Gray = AC1

Green = CT

Brown = AC2

TC1 = TC1

TC2 = TC2

TC3 = TC3 (not on e18S, e23S, and e28S)

REPLACING ONE-TOUCH™

See this video: hotkilns.com/replace-dynatrol (Note the process of changing a DynaTrol is very similar)

- 1) Unplug kiln or turn off the kiln at the fused disconnect switch.
- 2) Remove the four #6 screws that hold the One-Touch™ in place from the front face of the control panel.
- 3) Open up the control box and hinge down for access (as shown on page 3)
- 4) Pull off the spade connectors from all the connection points on the back of the control. Loosen the screws that hold down the thermocouple wires and pull out the wires from under the screw heads. It is OK to remove the screws if this is easier for you. First note where all the wires go. These are all clearly marked with color coding on the Wiring Diagram.
- 5) Pull old control out. Put new control in and screw in place with the #6 mounting screws. Replace wires on proper connectors.
- 6) Be careful to get the Red or Yellow of the thermocouple wires to match the colors painted on the control board.

TROUBLESHOOTING AND REPAIR INSTRUCTIONS FOR L&L KILNS

Picture showing thermocouple wires installed on Control. One screw is removed to show how the TC wire should be prepared with a "U" shape.

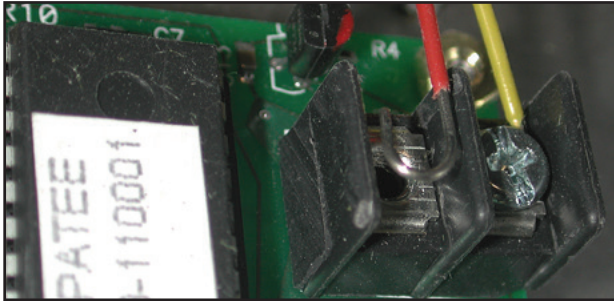

7) Double check that the proper color coded wire goes to the proper terminal.

Orange = J5

Gray = J2

Green/Yellow= J4

Brown = J3

REPLACING TRANSFORMER

See this video: hotkilns.com/change-transformer

- 1) Unplug kiln or turn off the kiln at the fused disconnect switch.
- 2) Open up the control box and hinge down for access (as shown on page 2).
- 3) Using needle nose pliers pull off the wires from the transformer. **THIS CAN BE TRICKY.** It can take a good bit of force sometimes to remove these little spade connectors. You will probably not be able to do it with just your hands. Also the spade connectors on the transformer are not very strong. Take your time. Of course, if you are replacing a bad transformer it doesn't matter if you damage it.

Shows wires being pulled off the control transformer.

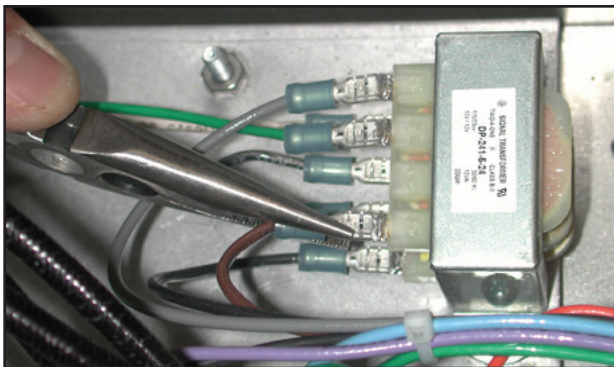

- 4) Unscrew the two #8 screws that hold the control

transformer onto the Contactor Panel and remove the transformer.

- 5) Before installing the new transformer put the small jumper wire onto terminals #2 and #3 on the bottom row of terminals. Note the little numbers by the contacts.

REPLACING POWER RELAYS

See this video: hotkilns.com/change-relay

- 1) Unplug kiln or turn off the kiln at the fused disconnect switch.
- 2) Open up the control box and hinge down for access (as shown on page 2).
- 3) Pull off the wires to the relay(s) that you are replacing. Everything is color coded and marked so you can refer to the wiring diagram when replacing if you forget where the wires go. The wire lengths also don't give you much choice and will help keep you from making a mistake.
- 4) Unscrew the #8 screws that hold the relays in place. Remove old relay and replace with new one.
- 5) Visually inspect the wire connectors. Do they look corroded or "cooked"? Are the wires frayed? Any corrosion on the wire itself? If any of this is questionable you may need to replace the appropriate wire harness.
- 6) Reconnect all wires. Visually inspect to make sure the spade connectors are down as far as they can go and feel to see that they are tight (a gentle tug should not remove one). If they are loose for some reason remove the wire and slightly squeeze the spade connector with pliers to tighten it.

IMPORTANT: The slip on wire connectors can not be loose or corroded. If there is a bad connection then heat will be generated and the component that they slip onto (relay, terminal strip, etc) may overheat and fail. If you squeeze the slip on terminal to make it tighter - be sure to squeeze it evenly so that one side is not tight and the other loose. If there are any doubts about the integrity of the wire or the connector replace the whole wire or harness.

REPLACING FUSE HOLDER

See this video: hotkilns.com/change-fuse-holder

- 1) Unplug kiln or turn off the kiln at the fused disconnect switch.
- 2) Open up the control box and hinge down for access (as shown on page 2).
- 3) Remove the wire connectors from the end of the fuse

TROUBLESHOOTING AND REPAIR INSTRUCTIONS FOR L&L KILNS

holder on the inside of the panel.

- 4) Unscrew the nut that holds the fuse holder in place.
- 5) Remove and replace with a new fuse holder. Reconnect wires.

REPLACING THERMOCOUPLES

See this video: hotkilns.com/change-thermocouple

- 1) Unplug kiln or turn off the kiln at the fused disconnect switch.
- 2) Remove the Control Box and Element Terminal Box as shown in the Assembly Instructions.
- 3) Remove the Thermocouple Lead Wires.
- 4) Unscrew the Thermocouple from the kiln (these are #6 x 1-1/2" screws)
- 5) Remove Thermocouple.
- 6) Remove Thermocouple Protection Tube. Shake it and dump out the oxide powder that has accumulated inside the tube. Then reinsert the tube into the hole in the kiln.
- 7) Install a new Thermocouple and screw in place.
- 8) Replace Thermocouple Lead Wires and tighten. Be sure to get Red matched to the Minus (-) sign and the Yellow matched to the Plus (+) sign.

Picture showing end of thermocouple.

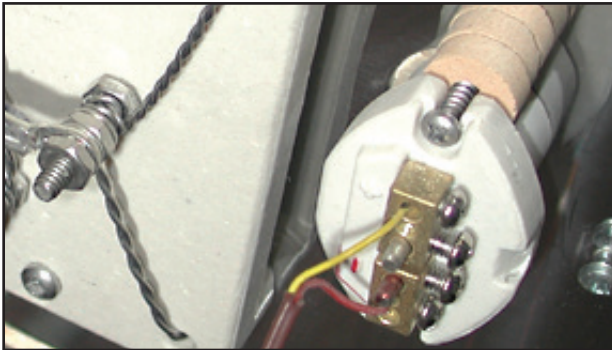

CHECKING ELEMENT OHMS

See this video: hotkilns.com/test-resistance-ez

See the instructions in the TROUBLESHOOTING Section of your instruction Manual (ELEMENT TROUBLESHOOTING & INSTALLATION INSTRUCTIONS) or here: hotkilns.com/element-troubleshooting

Element Ohm Charts

Check your wiring diagram for resistance values for your kiln. (Note - only some popular models are listed here.)

Easy-Fire Element Ohm Chart

MODEL	VOLTS/ PHASE	ELEMENT OHMS	CIRCUIT OHMS
e18S-240	240/1	9.6	4.8
e18S-208	208/1	8.3	4.2
e18S-220	220/1 (non-US)	8.8	4.4
e18T-240	240/1	9.9	5.0
e18T-208	208/1	7.4	3.7
e18T-220	220/1 (non-US)	8.3	4.2
e18T-240-3P	240/3	9.9	5.0
e18T-208-3P	208/3	7.4	3.7
e18T-380-3P	380/3 (non-US)	8.3	4.2
e23S-240	240/1	23.5	11.8
e23S-208	208/1	20.0	10.0
e23S-220	220/1 (non-US)	21.5	10.8
e23T-240	240/1	28.9	14.5
e23T-208	208/1	25.0	12.5
e23T-220	220/1 (non-US)	26.5	13.3
e23T-240-3P	240/3	28.9	14.5
e23T-208-3P	208/3	22.7	11.4
e23T-380-3P	380/3 (non-US)	24.5	12.3
e28S-240	240/1	19.3	9.7
e28S-208	208/1	16.7	8.4
e28S-220	220/1 (non-US)	17.2	8.6
e28T-240	240/1	28.9	14.5
e28T-208	208/1	25.0	12.5
e28T-220	220/1 (non-US)	26.5	13.3
e28T-240-3P	240/3	20.0	10.0
e28T-208-3P	208/3	17.4	8.7
e28T-380-3P	380/3 (non-US)	15.1	7.6

TROUBLESHOOTING AND REPAIR INSTRUCTIONS FOR L&L KILNS

School-Master Top Element Ohm Chart

MODEL	VOLTS/ PHASE	ELEMENT OHMS	CIRCUIT OHMS
SM23T-240	240/1	29.3	14.7
SM23T-208	208/1	25.3	12.7
SM23T-220	220/1 (non-US)	26.8	13.4
SM23T-240-3P	240/3	29.25	14.7
SM23T-208-3P	208/3	23.0	11.5
SM23T-380-3P	380/3 (non-US)	24.8	12.4
SM28T-240	240/1	29.3	14.7
SM28T-208	208/1	25.3	12.7
SM28T-220	220/1 (non-US)	26.8	13.4
SM28T-240-3P	240/3	20.2	10.1
SM28T-208-3P	208/3	17.6	8.8
SM28T-380-3P	380/3 (non-US)	18.8	9.4

School-Master Bottom Element Ohm Chart

MODEL	VOLTS/ PHASE	ELEMENT OHMS	CIRCUIT OHMS
SM23T-240	240/1	28.3	14.2
SM23T-208	208/1	24.5	12.3
SM23T-220	220/1 (non-US)	25.9	13.0
SM23T-240-3P	240/3	28.3	14.2
SM23T-208-3P	208/3	22.2	11.1
SM23T-380-3P	380/3 (non-US)	24.0	12.0
SM28T-240	240/1	28.3	14.2
SM28T-208	208/1	24.5	12.3
SM28T-220	220/1 (non-US)	25.9	13.0
SM28T-240-3P	240/3	19.6	9.8
SM28T-208-3P	208/3	17.0	8.5
SM28T-380-3P	380/3 (non-US)	18.2	9.1

CHANGING ELEMENTS

SEE THESE VIDEOS FIRST

For most top loading kilns:

hotkilns.com/change-elements-ez

For kilns with Quad elements:

hotkilns.com/change-element-quad

See the instructions in the TROUBLESHOOTING Section of

your instruction Manual (ELEMENT TROUBLESHOOTING & INSTALLATION INSTRUCTIONS) or here: hotkilns.com/element-troubleshooting

REPLACING ELEMENT HOLDERS

See this video: hotkilns.com/change-element-holder

1) When ordering a new holder provide model number of kiln and length of the element holder. See the Parts List for this information.

2) Note that if the holder has melted badly you may need to either replace the brick that holds it or at least patch the brick with our Brick Repair Kit.

See the extensive instructions in the TROUBLESHOOTING Section of your instruction Manual or here: hotkilns.com/element-troubleshooting

CRACKS IN THE LID & BOTTOM

See these videos for bad cracks:

hotkilns.com/fix-cracks-front-load
and hotkilns.com/repair-cracked-top

See this video for hairline cracks:

hotkilns.com/repair-hairline-cracks

See the instructions in the TROUBLESHOOTING Section of your instruction Manual (TROUBLESHOOTING & FIXING BRICK PROBLEMS) or here: hotkilns.com/brick-troubleshooting

TIGHTENING STAINLESS BANDS

See these videos:

hotkilns.com/replace-side-brick-kiln
hotkilns.com/replace-side-brick-davinci

See the instructions in the TROUBLESHOOTING Section of your instruction Manual (TROUBLESHOOTING & FIXING BRICK PROBLEMS) or here: hotkilns.com/brick-troubleshooting

REPLACING FIREBRICK IN SIDES

See these videos:

hotkilns.com/replace-side-brick-kiln
hotkilns.com/replace-side-brick-davinci

See the instructions in the TROUBLESHOOTING Section of your instruction Manual (TROUBLESHOOTING & FIXING BRICK PROBLEMS) or here: hotkilns.com/brick-troubleshooting

TROUBLESHOOTING AND REPAIR INSTRUCTIONS FOR L&L KILNS

DRILLING OUT HOLES FOR PEEPHOLES

See the instructions in the TROUBLESHOOTING Section of your instruction Manual (TROUBLESHOOTING & FIXING BRICK PROBLEMS) or here: hotkilns.com/brick-troubleshooting

DRILLING OUT FOR ELEMENT CONNECTIONS

See the instructions in the TROUBLESHOOTING Section of your instruction Manual (TROUBLESHOOTING & FIXING BRICK PROBLEMS) or here: hotkilns.com/brick-troubleshooting

REPLACING BOTTOMS

See the instructions in the TROUBLESHOOTING Section of your instruction Manual (TROUBLESHOOTING & FIXING BRICK PROBLEMS) or here: hotkilns.com/brick-troubleshooting

REPLACING LIDS

See the instructions in the TROUBLESHOOTING Section of your instruction Manual (TROUBLESHOOTING & FIXING BRICK PROBLEMS) or here: hotkilns.com/brick-troubleshooting

MORE ABOUT TROUBLESHOOTING CERAMIC PROBLEMS

1) We provide many firing tip brochures from Orton in the pdf library on our website. For a more in depth explanation Orton has a great booklet called Successful Firing Practices. They also have a number of other booklets available such as Cones and Firing (20 pages), Using Orton Cones/Temperature Charts, Kiln Safety Booklet, Kiln-Sitter Maintenance & Repair and Porcelain Firing Guide. Contact Orton at 614-895-2663 for more information. See ortonceramic.com for lots of very helpful information on how to use cones and for many firing tips and great information on firing kilns.

2) Check out a book called Electric Kiln Ceramics written by Richard Zakin, a book called What Every Potter Should Know by Jeff Zamek and Mastering Cone 6 Glazes by Ron Roy and John Hesselberth. Check out a book called "Ceramic Faults and their remedies" by Harry Fraser, A&C Black, London.

4) The magazines Ceramics Monthly (ceramicsmonthly.org) and Clay Times (claytimes.com) have many good articles and resources.

5) Also check out the great web resource, the Clayart discussion group at potters.org.

6) Check the links page on our web site.

7) Your ceramic supplier is a good source of knowledge and will have a wide variety of helpful books and videos as well

TROUBLESHOOTING AND REPAIR INSTRUCTIONS FOR L&L KILNS

Photo of a 1-phase control panel for a three section Easy-Fire kiln

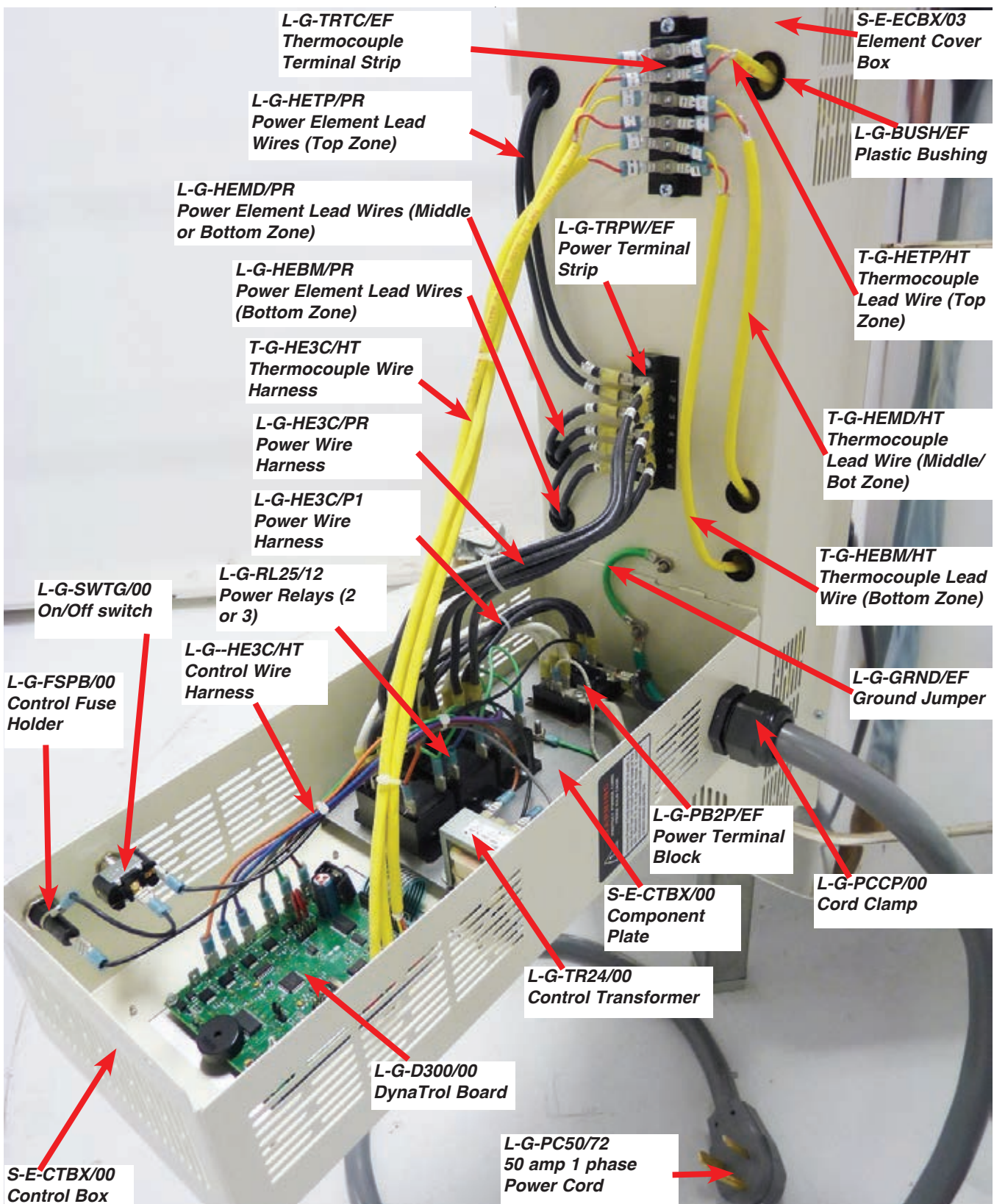

TROUBLESHOOTING AND REPAIR INSTRUCTIONS FOR L&L KILNS

Photo of a 3-phase control panel for a three section School-Master kiln

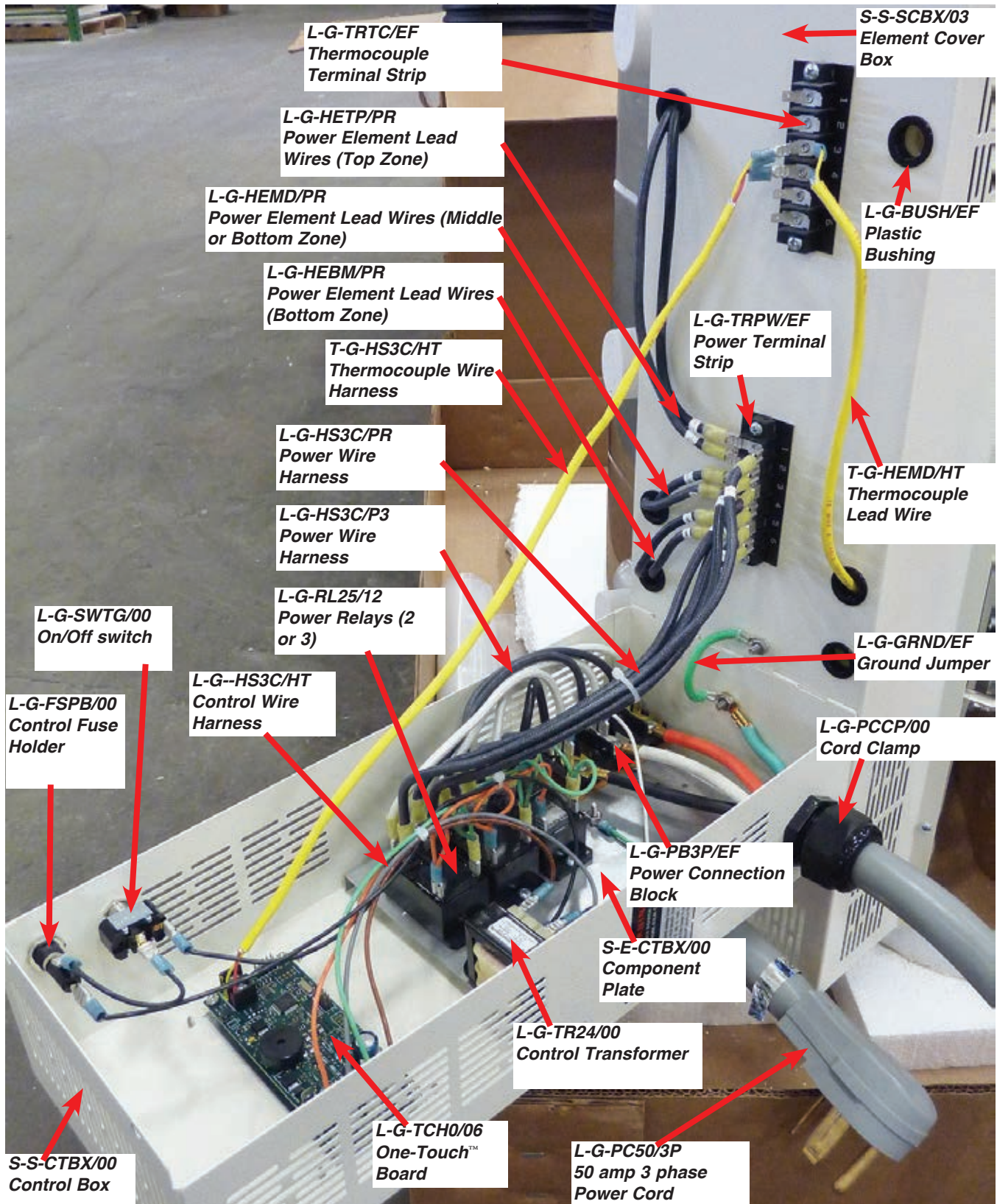

This page left intentionally blank

BASIC ELECTRICITY TROUBLESHOOTING FOR L&L KILNS

SAFETY CHECKLIST

When repairing a kiln or working around any electrical equipment, always remember...

1. Wear appropriate PPE (personal protective equipment): rubber-soled/closed-toed shoes, safety goggles, or face shield if possible, work gloves, long pants and short sleeves, and remove all jewelry.
2. Do not work on live equipment unless absolutely necessary: unplug power cable and lock out electrical power.
3. If working with live equipment: use only one hand near the equipment; when touching the leads of a multimeter to your circuit, clamp one of them in place and operate the other lead with one hand, keeping your free hand away from the equipment.
4. Clean the area around the kiln and make sure it's free of water.
5. Use the proper tools and don't improvise: for example, use a fuse puller to remove blown fuses; don't use a screwdriver for this.

BASIC ELECTRICITY FOR KILNS

Electricity can be measured in four different ways: amps (current), volts (energy or potential energy), ohms (resistance), and watts (power). You will likely recognize a few of these as in your 15 amp, 120 volt outlet or your 60 watt light bulb. Let's go into a little more detail on each component of electricity.

Volts:

Volts can be thought of as the force or pressure pushing the electricity through the circuit. The higher the voltage the higher the force. (This is why high voltage can be dangerous). Voltage will likely be predetermined in your location, but it varies from place to place. In the United States, we typically have 240V available in most homes with 208V or 480V available in industrial or commercial settings and many schools. Some of your major household appliances (like ovens and house-sized air conditioners) will use 240V while your typical household outlets will use 120V for your small electronics.

Amps:

Amp(ere) is the unit of measurement for electrical current or flow. The higher the amperage the greater the total volume of electricity. Current is important because it represents the strain that will be placed on your electrical system. Your

house for example will only have a set amount of amps (very typically 200 amps) that it can handle and every wire and component must be sized to handle the appropriate amps.

Ohms:

Ohms are the measure of resistance to flow in an electrical circuit. Certain materials are more conductive than others (think copper vs. rubber). Copper has a very low resistance, which allows electricity to freely flow. Our elements are made of a metal alloy that is somewhat resistive, which is good because where there is resistance, heat builds up. Otherwise the kiln would never get hot!

Watts:

Finally, watts are the measure of power. This is important because the more power you have, the faster your kiln will heat up and the higher temperature it can get to. Larger kilns will need more watts than smaller ones, as they need more power to heat up the space in them.

Ohm's Law:

All four of these measurements are related to each other in what is called Ohm's Law. Using this, we can use two measurements to find a third. For example, we can find a kiln circuits amperage by dividing volts by ohms.

Mathematical Relationships (formulas)

For use with single phase only: The electrical industry has designated letters to stand for amps, volts, ohms, and watts.

Amps = "I" (think "intensity of amperage")

Volts = "E" (think "energy")

Ohms = "R" (think "resistance") (Ω is the symbol used to indicate ohms)

Watts = "P" (think "power")

Ohms Law in diagram form.

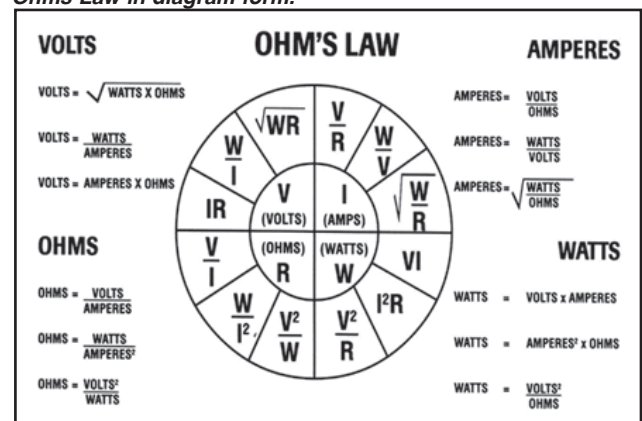

BASIC ELECTRICITY TROUBLESHOOTING FOR L&L KILNS

Single vs. Three Phase:

Electricity can also be delivered in two ways: single or three phase. Single phase means that electricity is moved along two “hot” wires. Think of it as flowing in one wire and out the other. Three phase meanwhile utilizes three “hot” wires to distribute electricity. The advantage here is that current is more spread out meaning that your kiln will draw fewer amps. Fewer amps means smaller wire and circuit breaker are needed.

THE WATER ANALOGY FOR UNDERSTANDING ELECTRICITY IN KILNS

Electricity is analogous to water

Electricity is easiest to understand when compared to water flow and pressure. As far as your kiln is concerned, its supply of electricity is like a huge reservoir of water. Imagine that a kiln is like a bucket with small holes for the water to leak out of (which would represent the heat loss of the kiln). Imagine that the water flowing into the bucket is like electricity. To fill two different sized buckets with the same porosity (i.e. same number of small holes per square inch which would be like the standard heat loss in firebrick) you will need different flow rates of water. If you turn on the small 2.6 cubic foot model e18S, electricity will flow into the kiln at one particular rate, measurable in “watts” per hour (actually Kilowatts per hour, or kWh, 1000 watts = 1 kWh). If you turn on a T3445 which has 34.5 cubic feet, electricity will flow into it at a much greater rate, still measurable in watts per hour. Likewise the larger bucket needs more gallons per hour than the smaller bucket not only to get filled at the same speed but to get filled up at all (because of the porosity). This analogy can help you to understand why it takes longer or might even be impossible for some kilns to heat up to very high temperatures. Note that the heat loss gets greater as the kiln gets hotter so it takes more and more electricity to heat a kiln the hotter it gets. It is like the porosity increasing over time as you fill up the bucket in the above analogy.

Amps (amperes) = flow

If the volume of water can be measured in gallons per second, then the volume of electricity flowing is measured in “amps”, a particular amount of electrons flowing through a wire in one second.

Volts (voltage) = pressure

Water is forced through the pipes by water pressure. A water tank at the top of a hill will provide you with more water pressure than a water tank only half-way up the hill. Electricity is forced through the wires by electrical pressure, called volts. A 12 volt battery is like the lower water tank: there is not much voltage to push the electrons along the wire. A 120 volt house power source is like the higher water tank, pushing a much greater volume of electricity (many more amps) down the same diameter wire than the 12 volt source.

Ohms (resistance) = resistance to flow

Say your house in the valley is somehow fed by both of these two water tanks. Sink number one has water from the top-of-the-hill water tank flowing to it. Sink number two, which is right next to sink number one, has water from the half-way-up-the-hill water tank flowing to it. Sink number one will have much greater water pressure and much more water coming from it than sink number two (assuming the same size orifice in the faucet). To get them to flow at the same rate, you must use a smaller diameter pipe to connect the water to sink number one than the pipe connecting the water to sink number two. By restricting the heavier flow of water with a smaller pipe, you can make the same amount of water come out of each sink. Electricity can be restricted (or “resisted”) as well. A small diameter wire can resist electricity like the smaller pipe resisted the water. In the same way that a large pipe will let more water through than a small pipe, a thick wire will have less resistance and will allow more electricity through than a thin wire. A short wire will have less resistance and let more electricity through than a long wire. This amount of electrical resistance can be measured in terms of “ohms”. The higher the number of ohms, the higher the resistance of the circuit.

Watts (power) = work

In the same way that the combination of water pressure and the actual water itself (measured in gallons per second) comes together to perform “work”, the combination of voltage (pressure) and amps (volume) comes together to perform “work” as well. This electrical work is measured by multiplying the values of the volts and the amps together. The result is called “watts”. Watts are a measurement of the work done by electricity.

Single Phase Power

Like voltage, the phase is specific to each location. The huge electrical lines you see across the country use three “hot” lines, what is termed “three phase”, with 1000’s of volts

BASIC ELECTRICITY TROUBLESHOOTING FOR L&L KILNS

running through them. From these three “hot” lines any two can be tapped (eventually, after stepping down the voltage through transformers) to provide power for any single phase circuit. To use a small electrical appliance as an example, if you trace the two wires that make up the cord for the appliance back through the lines you will eventually end up at two of the three wires from some main power line, and from there back to the generating plant. Often the power for a residential area is all single phase, from a junction station to a single house in the neighborhood. There may be no way for three phase power to be obtained without the equipment (mainly the extra line) in place. Industrial areas, large facilities, and schools usually have access to three phase power. Even then, sometimes the three phase ends at the main junction box in the building and the single phase power supplies branch out from there.

Three Phase Power

Three phase power uses three “hot” wires to supply electricity to the circuit. From the main power supply, the three lines remain three lines all the way through to the circuit. The same amount of electricity is simply split over three wires instead of two. The benefit of three phase is not a lower electric bill, since the kilowatts used are still the same. The benefit is in the cost of setting up the supply line itself. For example, a model T3427 208 volt in single phase draws 119.88 amps. It will need two “2/0” awg wires to supply it with power. The circuit breaker would need to be a two pole, 150 amp breaker, and any safety switches would need to be rated for at least 150 amps, if not more. That same kiln in three phase will draw 69.21 amps. It would only need three 2 awg wires to supply it with power. The circuit breaker would only need to be a three pole, 90 amp breaker, and any safety switches would only need a 90 or more amp rating. The cost of material and components for creating electrical lines are expensive. This cost increases exponentially with the size of the service. A 2/0 awg wire costs considerably more per foot than a 2 awg wire. The size of the conduit that houses the wires costs more as the diameter increases. A 150 amp circuit breaker is large and has a heavy protective housing. It has mechanical arms to provide leverage and physically move the electrical contacts together or apart. A 90 amp breaker is more familiar looking, with its plastic switching arm and the way it sits side-by-side with the other breakers in the box. The total cost (especially if power needs to be run for some distance) is much less for three phase than for single phase. The cost for another wire in the three phase is almost always offset by the potentially vast difference in total cost between installing single and three phase.

SERIES CIRCUITS

A circuit that only has one path over which current can flow is a series circuit.

A break in any part of a series circuit stops current flow.

All components in a series circuit see the same amount of current; therefore, each component must be capable of carrying that number of amperes.

RULES FOR SERIES CIRCUITS

- 1) The value of a current (amperage) flowing in a series circuit is the same through all parts of the circuit.
- 2) The total voltage of a series circuit is equal to the sum of the voltages across each part of the circuit.
- 3) The total resistance (ohms) of a series circuit is equal to the sum of the resistances across each part of the circuit.
- 4) Line voltage is divided across each component in a series circuit in proportion to the component resistance values. Referring to the schematic below, the total resistance is ($25\Omega + 30\Omega = 55\Omega$). Voltage measured between points A and B is:

$$240 \times (25\Omega/55\Omega) = 109 \text{ Volts.}$$

Voltage measured between points B and C is:

$$240 \times (30\Omega/55\Omega) = 131 \text{ Volts.}$$

Note that $109 + 131 = 240$ volts

Series circuit:

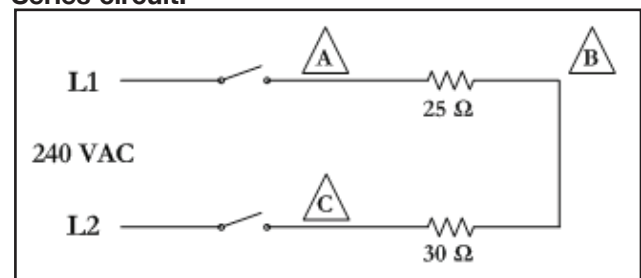

If there were (2) resistances whose values were equal, the voltage would be divided equally in half, and would measure 120 Volts.

Measuring Resistance in Series Circuits

The total resistance of a series circuit is the sum of all the individual resistances.

BASIC ELECTRICITY TROUBLESHOOTING FOR L&L KILNS

PARALLEL CIRCUITS

A circuit that has two or more current paths is a parallel circuit.

Each component is connected to line voltage, and current still flows through part of the circuit if one component fails.

Each component must be capable of withstanding the full line voltage.

The amount of current (amperes) varies according to the resistance of each separate part of the circuit.

The more circuit paths, the less opposition to the flow of electrons. Total circuit resistance decreases when more paths are added.

RULES FOR PARALLEL CIRCUITS

- 1) The total current (amperage) supplied to a parallel circuit is equal to the sum of the currents through the branches.
- 2) The voltage across any branch of a parallel circuit is equal to the supply voltage.
- 3) The total resistance of a parallel circuit is always less than the resistance of any of the branches.

Example of a Parallel Circuit in an L&L kiln

The following parallel circuit is typical of the DaVinci, Doll and J2900 kiln rings; there are (3) elements per ring, connected in parallel.

In this example, each element has a resistance of 49.8Ω. At 240 VAC, each element develops

$$(240 \text{ VAC}/49.8\Omega) = 4.82 \text{ Amperes}$$

The total circuit amperes, then, is

$$4.82 + 4.82 + 4.82 = 14.46 \text{ Amperes.}$$

Parallel Circuit:

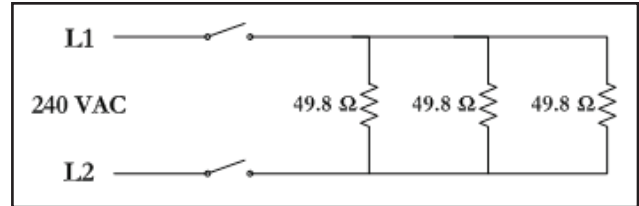

Measuring Resistance in Parallel Circuits

The total resistance is always less than the lowest reading of a single element. Often this is difficult to measure if all the elements in the circuit are connected to two points with no way to isolate them.

If all elements are known to all have the same resistance then you can multiply the number of elements by the resistance value of the entire circuit to get one element's approximate resistance. In the above example The resistance of the entire circuit is $49.8\Omega / 3 = 16.6\Omega$.

$$\text{Total Resistance} = 1 / ((1 / R1) + (1 / R2) + (1 / R3))$$

If the elements in the circuit have different resistances, like in School-Master kilns, there is no easy way to determine the individual resistances of the elements. The best way to solve an element problem with these kilns is to replace all the elements in the troublesome circuit. You can also measure the resistance on each element.

BASIC ELECTRICITY TROUBLESHOOTING FOR L&L KILNS

SERIES/PARALLEL or COMBINATION CIRCUITS

Certain circumstances require the use of Series/Parallel, or Combination circuits (in which series and parallel circuits are combined). In some front-loading kilns these circuits are used to combine, for instance, sidewall heating elements and backwall heating elements (often shorter than sidewall) in a combination circuit that is controlled by one power relay.

Example of a Series/Parallel Combination Circuit:

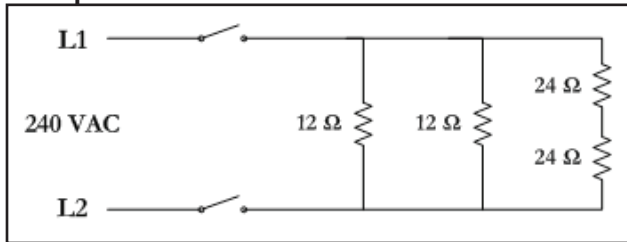

In the above example, the total resistance can be found by first dealing with each branch circuit individually. Starting from the right, this circuit is a series circuit; add the ($24\Omega + 24\Omega = 48\Omega$). The other two circuits are parallel and are equal in value (12Ω each); therefore, the resistance value of these two circuits is equal to ($12\Omega/2 = 6\Omega$). Drawing an equivalent circuit with (2) parallel circuits, one of 6Ω and one of 48Ω , looks like the following:

Series/Parallel Circuit simplified:

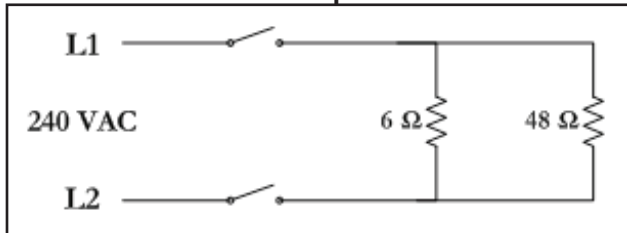

Solving for this circuit:

$$\text{Total Resistance} = 1 / ((1 / R1) + (1 / R2) + (1 / R3))$$

$$\text{Total Resistance} = 1 / ((1 / 6\Omega) + (1 / 48\Omega)) =$$

$$1 / (.1666 + .02083) = 5.33\Omega$$

WHERE TO GET MORE INFORMATION ABOUT ELECTRICITY

hotkilns.com/volts.pdf

www.elec-toolbox.com

This page left intentionally blank

ELEMENT TROUBLESHOOTING & INSTALLATION INSTRUCTIONS

TABLE OF CONTENTS

ELEMENT TROUBLESHOOTING	1
Why does an older kiln slow down?	1
Elements expand and grow with age	1
What if I see charred and blacked corners?	2
Factors shortening element life	2
Element Terminal Burn-out	3
CHECKING ELEMENTS	3
Elements	3
Element Connections	4
HOW ELEMENTS ARE WIRED	4
Why is this important?	4
Series Circuits	5
Parallel Circuits	5
Series-Parallel	5
Specific to non-sectional kilns:	6
POWERED BOTTOMS	6
OTHER TYPES OF ELEMENTS	6
Heavy-Duty elements	6
APM Elements	6
Increasing Power in Your Kilns	6
REMOVING OLD ELEMENTS	7
CHECKING ELEMENTS	8
STRETCHING ELEMENTS	9
JUPITER ELEMENT STRETCH LENGTHS	9
IF ELEMENTS NEED TO BE STRETCHED	9
INSTALLING NEW ELEMENTS	9
FIRST FIRING WITH NEW ELEMENTS	10
REPLACING ELEMENT HOLDERS	10
Method #1	10
Method #2	11

ELEMENT TROUBLESHOOTING

Getting E-1 Error

If you get an E1 or E-1 or Err1 error code on your DynaTrol or On-Touch control it means that your kiln no longer can get to temperature. It is slowing down. There are three main causes of this in order of likelihood:

- 1) Your elements have aged and need to be replaced. This is most likely when you notice the kiln gradually slowing down.
- 2) One or more contactors or relays have failed. This is most likely if you notice a sudden change.
- 3) You have a low voltage problem. This is most likely if you find this happening in the summer.

Why does an older kiln slow down?

Old elements generally increase in their resistance. Mathematically this increase in resistance will decrease the amount of amperage and, ultimately, the amount of heat given off by the elements. This is why older kilns sometimes go so slowly and may not reach their maximum

temperature. Periodic element resistance readings using the multimeter will allow you to check the “health” of your elements. Of course, a slow firing kiln is the first indication that you have an element problem.

Elements expand and grow with age

If you fire low-fire clay and glazes and never get above cone 4 or so, your elements will last a long time, especially if you are only bisque firing. This is good, to a point. If you only low-fire, the problem you are most likely to encounter over time is that the elements expand as they age. The length and the coil diameter increase. Meanwhile the atmosphere in the kiln slowly eats away at the metal of the element. Although the total resistance usually increases as the elements age, sometimes it decreases, or reverses itself. This usually only happens when the elements are very old but have not yet failed completely. As the element expands, it binds up in the corners. This can make the individual coils push together and touch each other in the corners, making a short cut for the electricity, reducing the amount of element material the electricity must pass through, and therefore reducing the resistance in the whole element. This may make it hotter in the kiln, but if there is a lot of element material jammed in the corners there will not be enough material left in the coiled form to radiate the heat generated by the increased amperage and decreased resistance. Only the parts of the wire not touching the coils on either side of them will emit heat. More amperage through the electrical components in the control could cause damage if the situation continues or the resistance drops far enough.

In addition, the expanding diameter of an element can make it difficult to get it out of the holder. Usually this will not happen to those firing to higher temperatures because the maximum temperature of the kiln is quickly compromised by increases in the resistance, requiring the elements to be changed long before they can jam up in the corners. Also, high temperatures and glaze firings are more prone to eating through the element, causing it to fail, before the element can expand enough to cause the problems mentioned above. Use the multi-meter. Visually inspect your elements.

What if I see charred and blackened corners?

The coils that sometimes get squashed together in the corners do not always touch each other, but they may be close enough to allow the electricity to ‘arc’ across the gap. An electrical arc can generate extreme temperatures for the millisecond it arcs. Charred and blackened corners of the kiln are warning signs for this problem.

ELEMENT TROUBLESHOOTING & INSTALLATION INSTRUCTIONS

Do not confuse this with what can be observed even with new elements; which is randomly sized sections of the coils glowing more quickly than other sections of the same coil. The annealing process of the wire causes this, and does not adversely affect the elements' operation in the kiln.

Factors shortening element life

1) Contamination (such as glaze or kiln wash). Silica, a main ingredient of both of these, attacks the element wire.

2) Tightly wound areas on element coils resulting from improper stretch. Have the elements been stretched evenly? This is important. If the element coils are bunched up along the length of the element the element will overheat where the coils are too close. Some replacement elements are shipped unstretched. Even prestretched elements may need some stretching. See section below on stretching elements.

3) Glaze accidentally rubbing off into holder and on element in loading kiln. If this occurs immediately vacuum the kiln and element holders thoroughly. Glaze will cause very rapid element failure.

4) Blow ups or explosion of bisque ware cause small pieces of clay to be blown into holder and element. If not immediately removed clay may melt, contaminating the element and element holder. Keep in mind that temperatures are considerably higher right next to the element so that you may very well exceed the clay melting temperature next to the element even if the kiln temperature is correct for the clay body.

To avoid explosions make certain clay is very dry before firing and, in the case of heavy handmade pieces, fire on low for a long period until you are sure ware is dried out thoroughly. If you hear a "pop" when firing such pieces, stop firing, cool the kiln. If blow-up has occurred, vacuum all element grooves very thoroughly. If you have the DynaTrol use the PreHeat feature for this final forced drying.

5) Firing pieces too close to elements. We recommend at least 1-1/2" from piece to element. Further if large flat surfaces are parallel to kiln wall.

6) Reducing atmospheres will destroy elements. Do not use wood chips, oils and other materials to generate a reducing atmosphere. A very rapid element failure may result. NOTE: Reducing atmospheres are the opposite of oxidizing atmospheres (plain air is an oxidizing atmosphere). The word reducing comes from the ability of a reducing atmosphere to "reduce" oxides.

7) Are any waxes, oils, carbon, fluorine, fumes present? Are you using any lead glazes? Iron-Chrome-Aluminum

elements require an oxidizing atmosphere to give dependable service. The aluminum in the element forms a protective aluminum oxide. Oil from tools or carbon from wax burnout will attack the element coating. Halogens such as chlorine or fluorine will attack the elements. Molten metals, for instance, zinc, aluminum and copper, react with iron-chrome-aluminum elements. Moreover, these metals oxidize easily and their oxides have an unfavorable effect on iron-chrome-aluminum. The salts of the alkali metals, halogen salts, nitrates, silicates, and compounds of borax, disturb the formation of oxide and are, therefore, harmful to these elements. This is also true of the oxides of such metals as copper, lead and iron. Do not use with free carbon. Lead oxide attacks the protective alumina oxide coating on the element. If you are using lead glaze (or are creating any of these other problems) be sure to use a kiln vent. Also try firing every other load or as often as you can with a non corrosive load (such as a bisque firing). This will help the element restore its protective alumina oxide coating. Note that clay almost always has organics (which will create a slightly reducing atmosphere, sulfur (which will also attack elements) and fluorine which is also corrosive. This is one reason why proper venting is critical for long trouble-free operation of your kiln.

8) Excessive soaking time will accelerate increase in element resistance. The higher the temperature, the longer the soak, the sooner the element will decrease in life. Usually short soaks work fine.

9) Are they genuine L&L elements? There are a number of people selling "replacement elements" for kilns. These people do not have access to the proper design information for L&L elements. Designing an element is a complicated process which balances such things as voltage, wire diameter, watt density, stretch ratio, etc. It is very easy to make an element that has the same watts as an L&L element and have nowhere near the other design qualities that result in long element life.

10) If the failure is taking place at the element end it may be twisted too tightly, causing stress at terminal through holes. This causes local overheating at the "through hole", and element failure. (Contact factory).

11) Make sure all elements are heating. If all elements are not doing their share of the work then the other elements will not last as long.

Element Terminal Burn-out

Sometimes the ends of the elements can burn out at the element terminals (connections). This can be due to any or all of the following causes:

ELEMENT TROUBLESHOOTING & INSTALLATION INSTRUCTIONS

- 1) The element ends are not twisted properly. If the twist is too loose this could generate extra heat at the element ends.
- 2) The holes where the elements go through the firebrick walls are too large. This could cause too much heat to escape from the kiln thereby overheating the element terminals. This can be remedied by lightly stuffing ceramic fiber (we have non-RCF ceramic fiber available in our parts list) in the element holes.
- 3) The element connection hardware may not be tight enough. A loose connection can generate heat and cause oxidation of the hardware which in turn will cause a worse electrical connection (because of resistance) and more heat. Replace with new hardware.
- 4) The hardware should be stainless steel or at least nickel plated. Check to see if the hardware is in good shape. If not replace at least the hardware with stainless steel hardware or better yet replace the whole terminal board assembly with one of our new ones.

CHECKING ELEMENT OHMS

See this video: hotkilns.com/test-resistance-ez

The most common cause of kiln slowdown, E-1 messages, and failure to reach temperature is element wear. As your elements age they generally increase in electrical resistance. According to Ohm's Law, when resistance, measured in Ohms, increases, both Watts and Amperes will decrease, assuming Voltage remains constant. Since Amps and Watts are the measures of current and power respectively, they can be thought of as the amount of juice that your kiln has to generate heat. Obviously if you don't have enough power, your kiln will fire slowly and might not even reach the desired temperature.

Using resistance, we can tell exactly how much power your kiln has lost over the course of your element's life. For example on an e23T that uses 240V, a brand new kiln section would read about 14.5 ohms. If you measured this same kiln section after several months of cone 6 firings let's say and the reading was 16.5 Ohms, you would know that this section of elements has lost approximately 14% of it's power ($16.5/14.5=1.138$, or close to a 14% increase). Again, an increase in resistance means decrease in power. A very general rule of thumb is that most people will typically begin to notice some slowdown once you've lost more than 10% of your power. It will certainly vary based on the kiln you have, your voltage, as the types of firing you do. People only doing low fire work will continue to get by on lower

power than those needing to go to higher temperatures (cone 6+). As you can see, measuring your element Ohms is the best way to identify when elements need replacing.

Keep in mind that the ohms on the wiring diagram are per ELEMENT while your reading will be per SECTION. How you figure out the section ohms depends on whether the elements are wired in Parallel or Series. Most kilns are wired in Parallel except for JD230V and most 18" kilns like the e18T. For a parallel kiln you take the per element ohms listed and divide by the number of elements per section. Ex. e23T 240V 1 Phase is 28.9 Ω per element with two elements per ring = 14.5 Ω per section. Ex. 2. JD2927 240V is 36.5 Ω per element with three elements per ring = 12.2 Ω per section. See this link for more info on Series vs. Parallel

Here we will show how to best measure your element resistance for two groups of L&L Kilns, into which most models fall.

Easy-Fire, eQuad-Pro, Liberty Belle, Doll, School Master

In these series' of kilns a piggy-backed control panel covers up the element terminals.

1. Turn the power to the kiln completely OFF and unplug it if possible. If it is direct wired, then you should at least turn off all power at the disconnect switch or circuit breaker.
2. Open the outermost control panel by unscrewing it either from the element cover box in the case of Easy-Fire, eQuad Pro, School Master and Liberty Belle kilns or from the kiln body in the case of Doll kilns.
3. Once you open up that control panel you will see the element power wire terminal strip. See the picture. It will have numbered wires coming from the element terminal blocks and wires connecting to the power relays. There are two wires per kiln section/ring, so numbers 1 & 2 are for the top section, 3 & 4 for the middle, and 5 & 6 for the bottom section on a three ring kiln.
4. Set your multimeter to Ohms (Omega symbol Ω) and using your testing leads, place one in between the two tabs/terminals with #1 wires connected. There is a small circular divot that the lead fits into (see picture). Put the other lead on terminal #2 and make note of the reading. Repeat the process for 3 & 4 and then for 5 & 6. Remember that each pair of wires represents one section.
5. Compare your readings to those on the wiring diagram in your instruction manual. Keep in mind that the ohms on the wiring diagram are per ELEMENT while your reading will be

ELEMENT TROUBLESHOOTING & INSTALLATION INSTRUCTIONS

per SECTION. See above for more info on understanding the readings.

Jupiter, Davinci

In these series' of kilns, the control panel is separated from the kiln body and the element terminals are connected to the controls via external jumper cords or plugs.

1. Turn the power to the kiln completely OFF and unplug it if possible. If it is direct wired, then you should at least turn off all power at the disconnect switch or circuit breaker.
2. Unplug the first jumper cord from the control panel.
3. Set your multimeter to Ohms (Omega symbol Ω) and using your testing leads, place one lead on each of the "hot" prongs. They will be the flat ones.
4. Make note of the reading and move on to the next one.
5. Compare your readings to those on the wiring diagram in your instruction manual. Keep in mind that the ohms on the wiring diagram are per ELEMENT while your reading will be per SECTION. See above for more info on understanding the readings.

How to check ohms of an entire L&L kiln section. Put the test leads of the multi-meter on the two "hot" plug terminals:



HOW ELEMENTS ARE WIRED

Why is this important?

The way the elements in a particular kiln are wired is important. Different wiring schemes with the same resistance elements will yield drastically different results. For example, if a kiln section or group of elements is out, and the kiln is made up of series circuits, you would first look at the elements because even one element out in a series circuit can make all the elements in that circuit appear to be burned out. If this same kiln had parallel circuits you would

first look at the switch or relay. This is because in a parallel circuit, if one element is out the others will still light, so for all the elements in the parallel circuit to be out would mean that whatever controls the circuit (i.e. the switch or the switch by way of a relay) or the wires in-between would be suspect. CAUTION: Accidentally wiring a kiln with parallel element circuits will make it heat up incredibly fast, until the breaker trips. For instance, A J18 kiln wired properly, in series, draws 23 amps at 240 volts. Wired in parallel it would draw around 90 amps at 240 volts, which would be disastrous.

Series Circuits

In a series circuit, power flows through one element and then another. We can see this in how it is wired. Think again of power coming in one wire and out the other. The picture illustrates this by having power come in via the top left terminal bolt, go through the top element to the right hand terminal bolt, through the bottom element and then back to the power source from the bottom left terminal bolt. This is the most typical series setup.

Parallel Circuits

Parallel circuits meanwhile allow power to flow through both elements simultaneously in no order. The power is applied to the beginning and end of ALL the elements at once. Thus the resistance of the entire circuit is the number of elements in the circuit divided into the factory resistance value for one element.

Series-Parallel

Sometimes element wiring can be termed series-parallel. L&L's model J14 is a good example of this. It has two series circuits, wired in parallel. The model J230 is wired the same way, but its two series circuits are not as easy to recognize because each series circuit has only one element in it.

The J14, however, has series circuits with two elements in each one. Power still comes through the two wires inside the jumper cord, and goes to both ends of each circuit. At one of these ends, another wire, a 'jumper', conducts the electricity to the end of the other series circuit, which begins at the end of the first circuit so they can share one power wire. Thus, both series circuits get power at the same time, making them series-parallel circuits. What this does to the total resistance of the J14's element circuit is intriguing. If each element has 10 ohms, each series circuit has 20 ohms (2 elements multiplied by 10 ohms each). Two 20-ohm circuits wired in parallel equals 10 ohms total resistance, just like with one element, except now there are four.

ELEMENT TROUBLESHOOTING & INSTALLATION INSTRUCTIONS

Specific to non-sectional kilns:

In non-sectional kilns it can be difficult to tell the element circuits apart since the element connection board runs the entire length of the kiln and covers all the circuits. Trace the connecting wires to discover the beginning and end of each element circuit on the element connection board. Ideally, you would draw a picture of each element circuit before dismantling it. If you are just replacing the elements it is not necessary to know if they are wired series or parallel; it is imperative, though, that they go back together exactly how they came apart.

For a more in-depth description of Series, Parallel and Series-Parallel circuits, along with descriptive diagrams see BASIC ELECTRICITY TROUBLESHOOTING FOR L&L KILNS in the TROUBLESHOOTING Section for more information on circuit wiring. If you want even more information about electricity for kilns see hotkilns.com/volts.

POWERED BOTTOMS

The elements on the powered bottoms are typically the same as those in the kiln with some exceptions. Series elements cannot be used by themselves in a power bottom, so a parallel element must be used in smaller, series-wired kilns like the JD230V-PB.

OTHER TYPES OF ELEMENTS

Heavy-Duty elements

If your kiln was made after January of 1996 (the year and month are coded into the serial number) it has larger cross-section element holders. These new holders are capable of holding a larger diameter, heavy gauge element. These high grade heavy duty elements feature lower watt density than the standard elements and that, coupled with the heavier gauge wire, results in longer element life. If you are experiencing short element life because of your duty cycle (frequent firing, high temperature firing, long soak times) you should try these heavy duty elements. They have the same ohm rating (resistance) as the standard elements. This means that the power rating of the kiln does not change. It also means that you can use them with the standard elements. One consideration with mixing the standard and heavy duty elements is that the heavy duty elements will age more slowly than the standard elements and may have an effect on uniformity in the kiln. This is really no different than what you would experience when you change just one element and so have a new element

(unaged) with older elements. Dynamic Zone Control will automatically balance your system and compensate for this problem. We do suggest, however, that you put any newer elements in the bottom ring where temperatures tend to be cooler and hence need as much power as they can get. Keep in mind that L&L can not keep track of which elements you have and that you must specify heavy duty elements when ordering. If you don't specify heavy duty elements you will get standard elements.

APM Elements

APM is a special version of the Kanthal A-1 alloy used on kilns. It is sintered and resists the crystallization that normal Kanthal type alloy experiences. As a result it makes sense to use this when you are doing processes that require long holds at high temperatures (like crystalline glaze for instance). On the other hand these elements are very expensive and a subject to the same problems like glaze contamination that any elements can experience. See hotkilns.com/apm for more information.

Quad Elements

The quad element option gives you four rows of heavy duty elements to maximize element life and heating power. Double the element surface area means that quad elements will degrade at a slower rate than ordinary elements which is great for those firing to high temperatures. More surface area also means more radiated heat for faster and more even firings. Quad elements are also typically made from thick gauge element wire further increasing their durability. Note: Quad element designs use extra long elements to wrap around the kiln twice each meaning that the electrical specs are kept the same. Because of the need to have more element holders in the brick, quad elements are not interchangeable with regular elements. See hotkilns.com/quad-elements for more information.

Increasing Power in Your Kilns

If you have a JD230 you can retrofit the new Easy-Fire e23T elements in that specific model and increase the power rating of the kiln. That will give you about 10% more power to start with and therefore, as elements age, the lowering power will have less impact on your firings. See hotkilns.com/jd230-ez as an example. These elements can be retrofitted into older kilns.

ELEMENT TROUBLESHOOTING & INSTALLATION INSTRUCTIONS

CHANGING ELEMENTS

SEE THESE VIDEOS FIRST

For most top loading kilns:

hotkilns.com/change-elements-ez

For kilns with Quad elements:

hotkilns.com/change-element-quad

REMOVING OLD ELEMENTS

1) Unplug kiln or turn off the kiln at the fused disconnect switch.

2. First remove the control box or element boxes and their wire connections from the kiln. Before undoing any wires, however, label how the wires and the elements are configured inside the element boxes (take pictures if needed). After you are certain you have documented the wiring then you can carefully remove the wires.

3) Using a 3/8" nut driver remove the nuts that hold the element end onto the Element Terminal Bolt. If you don't have this tool you can use an adjustable wrench - it will just take longer.

A 3/8" nut driver:



4) Untwist the element end from around the Element Terminal Bolt. Straighten it out as much as possible.

Untightening the element terminal:



5) Cut the old elements off as close to the "through hole" on the outside of the kiln as possible. You want a straight element tail to pull through the through hole, not a crooked one.

FOR OLDER NON-CERAMIC TERMINAL BOARDS:
Remove all the old tails from the element connection bolts and re-tighten these bolts to the element connection board. You may have to remove the element connection board from the kiln to do this. If the bolts are corroded, replace with new stainless steel terminal bolts, nuts, and washers. If the terminal board itself is burnt or broken replace that as a complete unit with new hardware.

6) In most cases you can just lift the element out of the holder at this point. Sometimes, if the element has really disintegrated, you need to remove it in pieces with needle nose pliers.

Using a sharp tool like a screw driver lift the elements out of the ceramic grooves at the corners. You can slide the holder over to make enough of a gap to get the tool under the element:



Lift Elements out of the groove of the ceramic holders:

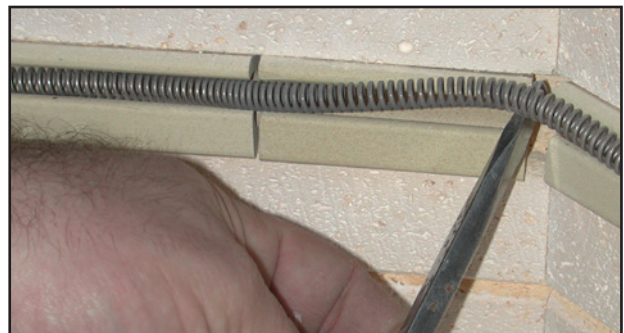

Sometimes very old elements can become wedged in the element holders, making it necessary to carefully pry/twist/break them out. A propane torch or just turning the kiln on for a few minutes (if it will come on) will soften the wire of the elements and make them easier to get out. Use heat protecting gloves such as welding gloves or heat treating gloves (you can buy these from L&L) and a pair of needle nose pliers to pull out the softened element. DANGER: You

ELEMENT TROUBLESHOOTING & INSTALLATION INSTRUCTIONS

could burn or electrocute yourself if you get the elements too hot or forget to unplug the kiln after warming them up. IF YOU DECIDE TO USE THIS METHOD BE VERY CAREFUL OF THE POTENTIAL FOR BURNING YOURSELF.

7) Be sure to check for failure points for evidence of contamination on the element and the element holder. If the element holder is contaminated it will cause rapid failure of the new element. Replace contaminated holders with new ones (See later in this sheet how to do this).

8) From the inside of the kiln, using needle nose pliers, grab the element as close to where it goes through the brick wall to the Terminal Block. Pull the element end through the hole. Be careful not to enlarge the hole in the firebrick. The brick is quite soft and will not take much abrasion.

Removing element from inside the kiln:



9) FOR OLDER MODELS WITHOUT CERAMIC TERMINAL BOARDS: There are normally ceramic insulator bushings on the outsides of the through holes that the elements pass through. On some models (particularly older J2900 kilns and DaVinci kilns) there are spacers to keep these insulators in place. These may fall out (and chip or break) if you are not careful. Be sure not to lose these spacers when replacing elements. Note carefully how they are positioned so you can replace in the same way. Note that on the new all ceramic terminal boards used on the J2900 and DaVinci kilns there are no bushings or spacers - it is all one integrated piece.

10) Once the old elements are out, carefully vacuum all the element holders. Watch for any glaze or material contamination. Anything that will melt (i.e. glaze, slip, porcelain, etc).will cause rapid failure of the new element. Chip or scrape carefully to remove the contaminant, or replace the affected element holders. DO NOT replace the element if there is foreign material stuck in the element holders. You must fix that problem first by either cleaning or replacing the contaminated element holder.

CHECKING ELEMENTS

Examine your new elements. Look to see the wire thickness is similar to that of the old ones. Look to see that the coils per inch and the diameter of the coils are also similar. Using your multimeter check the resistance of your new element. Compare to the factory resistance value(s) for your kiln's elements. Your reading should be no more than one ohm off (less for elements with ohm readings of less than 10 ohms). If you have received the wrong element in error call the factory to get it exchanged. This is the time to deal with the problem. DO NOT WAIT UNTIL YOU HAVE STARTED THE JOB, STRETCHED THE ELEMENT OR EVEN INSTALLED IT BECAUSE AT THAT POINT YOU WOULD NOT BE ABLE TO RETURN IT.

Checking resistance of the elements before you put them in. This is a good double-check and can save you a lot of trouble if there is a mistake. Put the probes on the twisted element ends about 3" from the beginning of the coil:

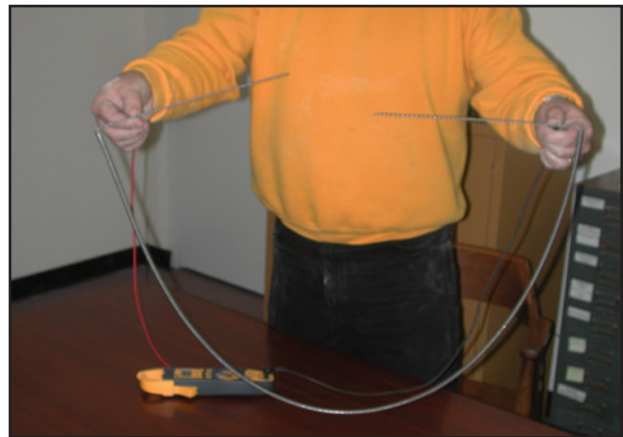

STRETCHING ELEMENTS

NOTE: Most replacement elements come prestretched. All elements are slightly understretched and will have to be adjusted for final fit. The following are instructions for how to stretch unstretched elements:

To determine total length to stretch an element measure total length of element grooves.

IF ELEMENTS NEED TO BE STRETCHED

1) Mark floor with two marks for stretched length. Have a helper stand on the tail of one element, and pull the other tail until the element is the proper length. The assistant must stand very firmly because a flying element could cause severe injuries. WEAR SAFETY GLASSES WHEN YOU DO THIS. Alternately clamp the end to something with vice-grips.

2) Examine for evenness of stretch. Selectively stretch close wound sections to provide uniformity of stretch.

ELEMENT TROUBLESHOOTING & INSTALLATION INSTRUCTIONS

- 3) Repeat this procedure several times.
- 4) You will have to pull element beyond last mark in order to obtain full stretch.
- 5) If overstretch occurs insert a metal rod or small diameter dowel into the element coil and compress with needlenose pliers.
- 6) Stretch uniformity is necessary for satisfactory element life.

INSTALLING NEW ELEMENTS

NOTE: We highly recommend you get all new element terminal hardware when you replace your elements. In fact we offer a 50% discount on element terminal hardware when buying elements.

- 1) Replace one element at a time so that you do not make a mistake with the wiring.
- 2) Insert the tails through the through holes from the inside out. Element ends should be straight at this point.
- 3) Pull them up tight up to the wall of the kiln by pulling from outside the kiln.
- 4) Lay the element into the groove. Note that the unfired element is going to have some springiness to it before it is fired for the first time. You may need to use a screw drive to press the element into the holder. **YOU DO NOT NEED PINS.**
- 5) **FOR KILNS WITH NON-CERAMIC TERMINAL BLOCK OR ON RETROFITTED KILNS WHERE YOU HAVE ADDED A CERAMIC TERMINAL BLOCK BUT STILL NEED BUSHINGS:** Be sure to replace the insulators and spacers over the element tails.
- 6) Consulting your picture or labeling, wrap the appropriate element tails around the appropriate element connection bolt, clockwise, once around, and cut off the excess tail. If you have the newer large washer system you just need to make a "U" around the bolt and let the large washer do the clamping.

Detail showing the terminal set:



Detail showing all the parts:



Detail showing how all the hardware gets assembled on the Terminal Bolt:



7) Install the elements and hardware:

- a) A washer goes under the first element
- b) Twist the first element end **CLOCKWISE** around the Terminal Bolt.
- c) The next element gets twisted around the Terminal Bolt on top of the first element.
- d) Then another washer goes over the Terminal Bolt.
- e) Then the nut goes over it and get tightened.
- f) Then a washer goes on.
- g) Then the Ring Terminal of the Power Lead Wire goes on.
- h) Then a washer goes on.
- i) Then another nut goes on and gets tightened. How tight you can make this is dependent on how tight you got the

ELEMENT TROUBLESHOOTING & INSTALLATION INSTRUCTIONS

element connection bolt onto the element connection board. A tight connection is very important, but if you tighten too much and twist the element on the bolt too far you could break the element, the bolt, or the insulator.

Detail showing how all the parts for an older style "red board" terminal system for a J2900 kiln:

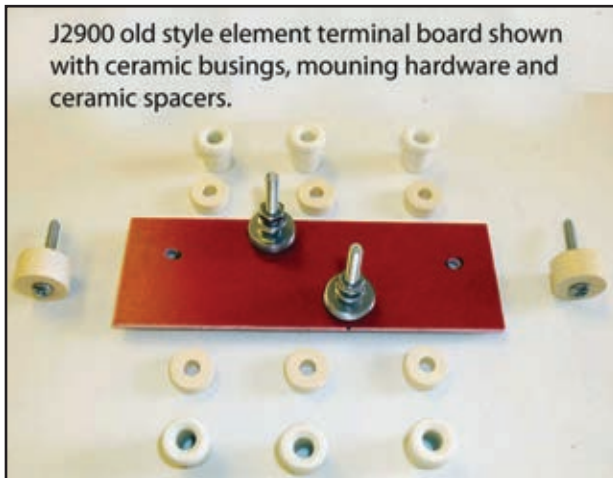

8) Place the wires from the jumper cord or connecting wires onto the appropriate bolts and tighten with stainless steel nuts.

9) Reattach the ground wires and the element box if the kiln has them. **DO NOT FORGET TO ATTACH GROUND WIRES. IF EACH KILN SECTION IS NOT GROUNDED THIS CAN BE VERY DANGEROUS.**

10) Test the ohms at the jumper cord's plug head or at the other end of the connecting wires.

11) Reattach the control box, turn the kiln on and make sure all the elements come on.

FIRST FIRING WITH NEW ELEMENTS

NOTE: You may experience some smoking from the kiln on its first firing with new elements. This, if it occurs, is due to residual oil left on the element wire when the wire was made. We recommend firing the kiln empty to cone 5 once to oxidize the new elements (no particular speed is necessary) and to seat the new elements in the holders.

REPLACING ELEMENT HOLDERS

See this video: hotkilns.com/change-element-holder

1) When ordering a new holder provide model number of kiln and length of the element holder. See the Parts List for this information.

2) Note that if the holder has melted badly you may need to either replace the brick that holds it or at least patch the brick with our Brick Repair Kit.

Method #1

1) This method leaves the kiln in tact. You break up the holder and remove it in pieces and then modify the new holder to snap into the groove.

2) Using a chisel or large screw driver and a hammer carefully crack the holder that needs to be removed.

Just take your time with this. You can break the holder into little pieces so that it comes out:



The holder shown with about half the job done:



ELEMENT TROUBLESHOOTING & INSTALLATION INSTRUCTIONS

The groove is shown with the holder removed:



Using Linemen's Pliers snap off the BOTTOM edge of the holder

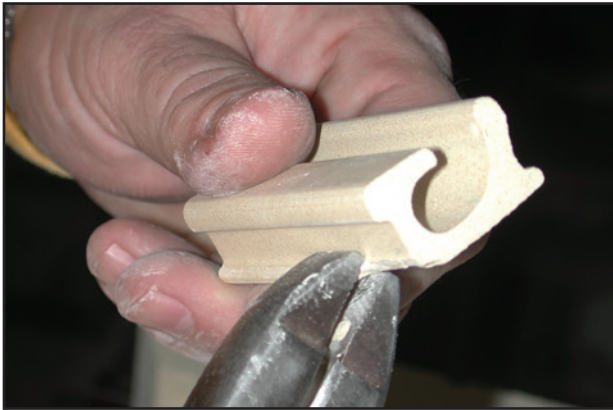

A normal holder compared to one with edge removed:



You can now just snap the new holder into the slot in the firebrick. It will hold in place with no cement:



Method #2

This method requires you to take the kiln sections apart.

- 1) Take the section with the bad holder off the kiln and put it on a flat surface like a flat floor or table.
- 2) Carefully pull the elements out of the element holders of the brick section involved and allow them to hang loose. Take great care not to "break" the element as they are very brittle after firing.
- 4) Loosen up the adjustable clamps that hold the stainless steel wrapping. Loosen them just enough to allow the brick to slide out with slight hand pressure (so that the other bricks stay in place). NOTE: If you don't have the section on a flat surface then the bricks will all come out of proper alignment at this point.
- 5) Pull up the brick with the bad element holder just enough to allow removal of the defective element holder and replace with new one. Slide the bad brick(s) out and put in new brick(s). Be sure the element holders line up with the other holders on either side. Note there is a top and a bottom in the element holder so be sure to get the orientation correct.
- 6) Retighten the clamps on the wrap. Alternately tighten the bottom and top clamp so that you don't cock the stainless casing.

TROUBLESHOOTING AND FIXING BRICK PROBLEMS

BRICK PROBLEMS

EXCESSIVE BRICK WEAR

1) Excessive brick wear can be the result of various conditions. Most common is improper curing of the brick when first fired. **FOLLOW THE INSTRUCTIONS FOR THE FIRST FIRING AND CURING CYCLE in the OPERATION Section of the instruction manual).**

2) All insulating firebrick expands and contracts when heated and cooled. Over time this will lead to cracking and spalling. Spalling is the continued cracking of the brick which eventually results in large pieces of the brick falling out from the brick section. This is a normal condition as long as the emphasis is on eventually. Factors such as how close the kiln is operated at or near maximum temperature, how often and how fast the kiln is cycled up to heat and then cooled, how heavy the loads are, all figure into the brick wear equation. There is no set rule as to how long a brick lining will last. There are some L&L kilns which are 25 to 40 years old with the original lining still in usable shape.

3) Frequent door openings when the kiln is at high temperatures can cause thermal shock, leading to excessive cracking and spalling.

INSTRUCTIONS FOR USING BRICK REPAIR KIT

To order see: hotkilns.com/brick-repair-kit

GENERAL NOTE: Firebrick is a very fragile material and subject to breakage, spalling and heat shock. The good news is that it is very easy to repair and maintain with the proper materials and techniques. Our Brick Repair Kit has all the materials you will need to do a first class job.



LIST OF BRICK REPAIR KIT MATERIALS

- (1) Firebrick piece
- (1) 1/8 pint of Brick Cement (in a 1/2 pint container)
- (1) Quart container of Brick Dust
- (1) 1/2 pint Brick Facing

MIXING A BATCH OF GROUT

The grout should be mixed up JUST prior to use. (Otherwise it will dry out). Mix the ingredients with a small spatula in a container (like a glass jar or plastic cup). Mix in the following:

1/2 cup firebrick dust

1/4 cup water

1 tablespoon Brick Cement

NOTE ABOUT GROUT

The special grout material is firebrick dust mixed with water and a small amount of cement. The cement makes a matrix of the firebrick dust. This compound dries into a material almost exactly like the original firebrick with the same color, consistency, texture and insulating properties.

BRICK REPAIRS

APPLICATION OF BRICK FACING/HARDENER

- 1) First brush and vacuum the surface of the brick clean to remove any loose material or crumbling firebrick.
- 2) Next wet the brick surface lightly. Use a paint brush or spray bottle (make sure there is no soap residue in the bottle).
- 3) Then apply a thin coat of the brick hardener with a soft brush over the surface of the firebrick. Do not make too thick a coat of the hardener or it will spall off. One or two light brushings or sprayings on wet brick is enough.
- 4) Let the hardener dry for 24 hours.
- 5) Run the First Firing Cycle (See the OPERATION Section in your manual).

REPAIRING SMALL HOLES & CHIPS IN BRICK

- 1) Brush and vacuum the surface of the brick clean to remove any loose material or crumbling firebrick.
- 2) Next wet the brick surface lightly. Use a paint brush or spray bottle (make sure there is no soap residue in the bottle).

TROUBLESHOOTING AND FIXING BRICK PROBLEMS

3) Apply a very thin coat of brick cement (no more than 1/3" to 1/6") all over the hole. Do this with your finger or a small brush.

4) Fill hole with the special grout material. Apply grout with a spatula (like plaster.) You can also use your finger. Push it into the hole. It is OK to let it be a rough surface or slightly larger than the hole it is filling.

5) Let dry for 24 hours.

6) Take some rough sandpaper and sand surface to even it out with the rest of the firebrick.

7) Run the First Firing Cycle (See the OPERATION Section in your manual).

8) You can brush on hardener or facing afterward if you desire.

REPAIRING VERY LARGE HOLES IN BRICK

See this video: hotkilns.com/repair-brick-front-load

1) Cut out an area around the brick chip with a small knife, saw or router. The hole that you make should have 90° angles so that a square or rectangular block will fit in the hole.

2) Cut a piece of firebrick to fit into this cut out hole. The piece should be slightly smaller than the hole (by about 1/16" to 1/8").

3) Both the hole and the brick piece should be brushed and vacuumed clean.

4) Wet the brick surface lightly. (Both the hole and the surface of the block that you are going to insert in the hole). Use a paint brush or spray bottle (make sure there is no soap residue in the bottle).

5) Apply the Kiln Cement to the surface of the piece that you are going to put in the hole as well as the hole itself. Use only about 1/32" to 1/16" of an inch of cement. Push the brick plug in hard and move slightly for a second or two to make sure the cement adheres to all surfaces.

6) Let dry for 24 hours.

7) Sand off excess brick and cement.

8) Cover with Brick Facing and allow to dry for another 24 hours.

9) Run the First Firing Cycle (See the OPERATION Section in your manual).

FIRST FIRING AFTER REPAIR

(See FIRST FIRING INSTRUCTIONS in the Operation Section). The only difference is that you can fire to a lower temperature because you do not need to reseal the elements. Firing to cone 05 instead of 5 is OK.

The kiln needn't be empty either.

If you have the DYNA-TROL program control fire the following program: Using the "Easy-Fire" mode fire on Slow Bisque to Cone 05 with a PreHeat setting of 3 hours and a hold of 1 hour.

For kilns with the manual control fire the kiln on low (setting #2) for two hours to bake out any moisture. Then set to medium (setting #5) for two hours and then increase enough to reach final temperature. Fire it to cone 05 (1888°F).

CRACKS IN THE LID & BOTTOM

See these videos for bad cracks:

hotkilns.com/fix-cracks-front-load
and hotkilns.com/repair-cracked-top

See this video for hairline cracks:

hotkilns.com/repair-hairline-cracks

1) It is quite normal to get hairline cracks in both the lid and the bottom firebricks.

2) They are caused by the expansion and contraction of the firebrick as it heats and cools.

3) As long as the bottom is fully supported by the stand the cracks in the bottom will not adversely affect the operation of the kiln.

4) The stainless steel clips we use in our lids also help keep these natural cracks from normally becoming a problem in the lids.

5) Note that it is possible to put another bottom under the original bottom as a second layer (this can also improve performance and heat up rate of the kiln).

8) You can tighten the stainless steel band.

TROUBLESHOOTING AND FIXING BRICK PROBLEMS

This crack is OK:



TIGHTENING STAINLESS BANDS

See these videos:

hotkilns.com/replace-side-brick-kiln

hotkilns.com/replace-side-brick-davinci

1) The brick will shrink slightly over time. This is more pronounced when using the kiln at higher temperatures like cone 10. If you only use the kiln for low fire bisque you may never notice this condition.

2) If the bricks shrink too much they will become loose.

3) Tighten the case by turning the screws of the case clamps. Do this 1/4 of a turn at a time on each of the clamps. Keep a balanced tightening (i.e don't tighten one clamp too much at one time). Slow is good.

Tightening the bands:

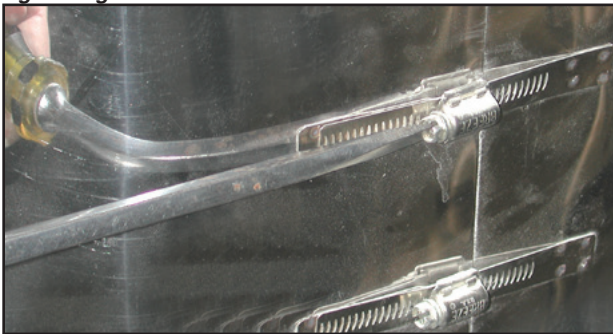

4) You can do this on the bands around the top and bottom also. This will help maintain the integrity of those slabs even if there is a crack.

REPLACING FIREBRICK IN SIDES

See these videos:

hotkilns.com/replace-side-brick-kiln

hotkilns.com/replace-side-brick-davinci

1) If you need to replace a firebrick piece in one of the sections do the following. While it does not require a great deal of experience to accomplish it does take time and patience.

2) Order the firebrick precut and prerouted from L&L Kiln. You can order this with the proper element holders already in place or you can reuse the holders from your old brick. Be sure to order it for your specific model kiln. Also, be sure to say whether it is a brick where the element connections come through (because this has different element holders).

3) There are no holes drilled in the brick for either peepholes or element connections. This has to be done in the field.

4) Take the section off the kiln and put it on a flat surface like a flat floor or table. Elements will have to be removed and probably replaced. If the elements are old they will be brittle. They may break so be prepared to get new elements.

5) Loosen up the adjustable clamps that hold the stainless steel wrapping. Loosen them just enough to allow the brick to slide out with slight hand pressure (so that the other bricks stay in place). NOTE: If you don't have the section on a flat surface then the bricks will all come out of proper alignment at this point.

6) Slide the bad brick(s) up and out and put in new brick(s). Be sure the element holders line up with the other holders on either side. Note there is a top and a bottom in the element holder so be sure to get the orientation correct.

7) Retighten the clamps on the wrap. Alternately tighten the two or three clamps (about a 1/4 or 1/2 turn at a time) so that you don't cock the stainless casing.

8) Sand off the top surface of the firebrick to match the surface of the other firebricks. Sandpaper will work fine. Reface with Brick Facing.

9) You can see this action in this video:

hotkilns.com/replace-side-brick-kiln

TROUBLESHOOTING AND FIXING BRICK PROBLEMS

DRILLING HOLES FOR PEEPHOLES

1) Some of the bricks that you may need to replace will need to have holes drilled in them in the field. These holes can not be drilled in the factory because the alignment would not be perfect.

2) To drill out for peepholes use a 1" diameter drill bit or hole saw. You can also drill with a smaller drill and then file out with a round hasp type file. Drill slowly through the firebrick using the prepunched hole in the stainless steel. You may have to remove the bit several times and clean it out as you drill deeper. **It is a good idea to have someone help you by watching from the side to make sure you are drilling straight. It is hard to see this when you are doing the drilling.**

3) For sections that have two element rows: the hole is drilled perpendicular to the stainless case.

4) For sections that have three element rows: the hole is not drilled at a perfect 90° perpendicular angle to the kiln case. It will be drilled at a slightly down angle (about 5° to 7°). This is to miss the element holders.

5) Before drilling, as a precaution, you can measure down from the top of the brick to the top of the existing hole in the stainless steel case. This measurement on the inside will show you where the top of the drill bit will protrude. Adjust your angle of drilling accordingly.

Drilling the peephole:



DRILLING ELEMENT CONNECTIONS

1) Use a 1/8" to 3/16" diameter drill bit and drill out from the center of the hole in the stainless steel case. Do this slowly with a speed control.

2) Do this perpendicular to the case.

REPLACING BOTTOMS

- 1) Remove the kiln sections.
- 2) Take the old bottom off the stand.
- 3) Put the new bottom on the stand.
- 4) Relevel the kiln. (This is important).
- 5) Replace the kiln sections.

NOTE: You may want to experiment with using the old bottom as a secondary back up bottom if it is not too badly damaged. Just make sure it is totally flat so that it doesn't crack the new bottom. Some people find that having this extra insulation thickness helps firing times and bottom uniformity.

REPLACING EASY-LIFT LIDS

1) Remove the Hinge Pin and take the old top off the kiln. See the Assembly Instructions for guidance if you have questions about how to do this. Use the Hinge Tool to take the tension off the spring. **BE SURE TO USE SAFETY GLASSES - THERE IS A LOT OF TENSION ON THE SPRING AND INJURY COULD RESULT.**

2) Remove the Top Hinge Part from the old lid. Note that there are three parts to this. There is the main Top Hinge Part. Then there is the Front Hinge Part (the little 3" x 4" aluminized steel plate with a small hole that gets attached to the front of the top with the screws for the Handle). Then there is the Handle. Note that the hole in the Front Hinge Part should be centered around the little stud that protrudes from the Top Hinge Part.

**A= Top Hinge Part, B= Front Hinge Part
C= Handle, D=Label**

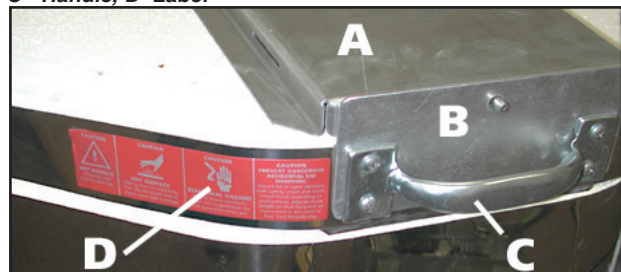

3) Using the old top as a guide, install the Top Hinge Part onto the new lid.

4) Reinstall the top and reset the spring. See the Assembly Instructions if you have questions about how to do this.

TROUBLESHOOTING AND FIXING BRICK PROBLEMS

REPLACING SMALL NON-SPRING HINGE LIDS

- 1) Remove one of the Cotter pins from the Hinge Bar.
- 2) Pull out the Hinge Bar.
- 3) Unscrew the chains from the stainless steel case of the lid.
- 4) Remove the Top Hinge Part from the old lid.

A simple hinge with parts marked

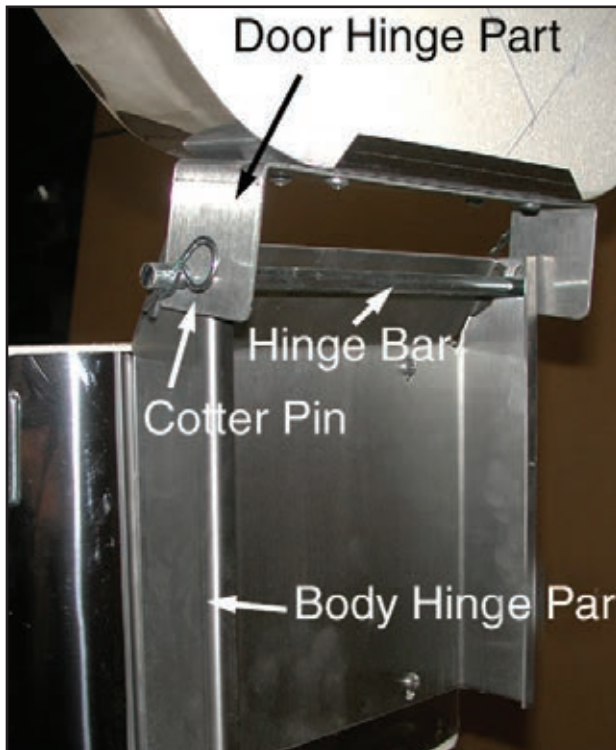

- 5) Using the old top as a guide, install the Top Hinge Part onto the new lid.
- 4) Reinstall the top.

REPLACING DAVINCI LIDS

See this video: hotkilns.com/replace-davinci-lid

This page left intentionally blank

LIBERTY-BELLE INSTRUCTION MANUAL

**SERVICE
& WARRANTY**

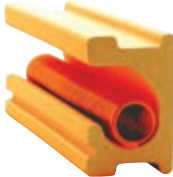

L&L Kiln's patented hard ceramic element holders protect your kiln.

SERVICE FOR L&L KILNS

IN GENERAL

SERVICE FOR YOUR KILN

L&L kilns are designed to be as easy to work on and fix as possible. This is one of the great advantages of L&L kilns.

TROUBLESHOOTING GUIDE

Check out the “Support” section of our web site, hotkilns.com for all of our troubleshooting references. We are constantly adding to our troubleshooting guides and the web site has the most up-to-date information on it. Also try the search engine on our website with your question.

THE MOST COMMON ERROR MESSAGES AND WHAT TO DO ABOUT THEM

Error 1, Err1: hotkilns.com/e1

Error D, ErrD: hotkilns.com/e-d

All Error messages on the DynaTrol:
hotkilns.com/error-codes

Adjusting and Calibrating the DynaTrol for More Accurate Firing: hotkilns.com/calibrating-kiln

What to do if the kiln fires slowly?: hotkilns.com/slow-kiln

YOUR LOCAL DISTRIBUTOR

Call your local distributor, most of whom service the kilns they sell. If they don't they may be able to direct you to a local kiln service person.

OTHER KILN REPAIR PEOPLE

Search for a local kiln service person online or try your local yellow pages. L&L may also be able to recommend a local service person. We maintain a listing of kiln service people around the country. If you can't find a person experienced specifically in kiln repair, then a good electrician is often more than adequate to repair most problems that commonly occur.

REMOVABLE CONTROL PANELS

Some of the more difficult problems occur within the control panel. One of the unique features of most L&L kilns is the easy ability to remove this panel and send it back to the factory for inspection and/or repair. Call the factory for details on your kiln.

CUSTOMIZED TECHNICAL SUPPORT

To get technical support from L&L Kilns please send an email to service@hotkilns.com

Include in your email the following important information:

1. Your name.
2. Your organization name.
3. The Serial Number, Model Number and Voltage information from your Data Nameplate.
4. Your phone number and possible times to reach you during business hours.
5. A description of the problem you are having and anything you have done so far to troubleshoot it.
6. **Send Photos!**

You will get prompt, effective, and detailed expert answers. We are committed to answering service emails within one business day but normally they are answered far more quickly. If you need a phone call we can help you better if we have this information before we call.

Note about element resistance values: You can find the proper ohms for your elements on the wiring diagram which comes with your instruction manual.

PREPARING FOR A TECHNICAL SUPPORT PHONE CALL

Get Your Wiring Diagram

Be sure to get your wiring diagram if you don't have it. You can get this emailed free from our office if you know your model number, serial number and voltage. This is the key to understanding what is happening electrically and it makes a great visual reference to share with the tech support department over the phone.

Get A Multimeter

Get a “Digital Multimeter”. Digital Multi-meters are inexpensive. For around \$50 or less you can get one at a place like Amazon or Home Depot. Get one that can test at least 250 volts AC and 28 volts DC, also ohms from 0 to 200, and is able to show at least the tenths decimal place for accuracy.

If You Need An Electrician

Sometimes you may need get an electrician or experienced person, to test live electricity if you cannot. If you get someone to provide on-site service, the kiln must be hot and exhibiting its problem when they test it. Sometimes it

SERVICE FOR L&L KILNS

is difficult to coordinate the electrician, a hot kiln, and our technical support on the phone all at the same time, but it can be necessary to make the most of the electrician's time, and to fix the kiln in a timely fashion. It is usually best also to discuss with our technical support department the date and approximate time an electrician is expected to arrive.

Be Aware Of Limitations

As a practical matter the technical support staff is limited by the fact that we are at a distance from your kiln, communicating by email or telephone and are often working with you through multiple sessions to fix your kiln's problem. We rely heavily on your accurate and complete description of the problem, and your responses to our questions. We rely on you to remember where we are in the process of fixing your kiln each time we talk. (Email is easier because there is a recorded thread of communication).

Application Support

Distributors often offer a degree of application support. For instance if you are having problems with firing your work the first place to go for answers is the people who supply your clay and glazes. We offer some application support on this web site but it is minimal. Generally, this is outside the scope of our service. Look at the External Links for many great sites that can help you.

Be Comprehensive And Proactive

We have found through long experience that is best when trouble starts to replace all of a certain part. If your elements are old and one burns out – change the whole set of elements. The same is true for thermocouples, thermocouple wires, element terminal screws, power cords, and contactors. Do not expect control panel components to reliably perform after 15 or 20 years. The heat of kilns causes unavoidable oxidation of electrical components - some that you can't see. Kilns need to be rebuilt occasionally. Changing JUST the part that is causing the immediate problem is just asking for more trouble in short order.

WHERE TO BUY PARTS

You can order parts through your local distributor or directly from the factory. L&L stocks almost all parts we sell including elements. We normally ship within one to three days although some parts do take longer. Most parts are listed at hotkilns.com/parts.

FREE LIFETIME SUPPORT IS CONTINGENT ON THE USE OF L&L FACTORY PARTS. USE OF NON-L&L PARTS WILL VOID THE WARRANTY.

WHAT WE CAN'T DO

We can not give you advice over the phone on hooking up your kiln to your electrical system. You must have a qualified electrician who can physically see what your specific electrical situation is and who understands any local codes.

SELECTING AN ELECTRICAL CONTRACTOR

A quality electrical contractor:

- 1) Complies with state and local codes and regulations.
- 2) Carries the proper business and workers compensation insurance.
- 3) Is knowledgeable on a wide range of new equipment, technology and design procedures.
- 4) Has a local facility, and is willing to have you visit.
- 5) Is prompt and courteous and provides fast, reliable service -- attempting to perform service at your convenience.
- 6) Is neat and well groomed. This neatness should be reflected in their vehicles and offices as well as their personal appearance.
- 7) Provides a detailed written proposal, clearly outlining the work to be done and the agreed upon cost, including labor and materials. Make sure you understand every word of any contract before you sign it.
- 8) Asks in detail about any problems and offers understandable solutions.

CONSIDER THE FOLLOWING

- 1) Ask for references. Find out if other customers were satisfied. Check with the local Better Business Bureau regarding any filed complaints.
- 2) Compare price. Get bids from a few contractors. Make sure you give each contractor the same specifications and materials needed for the job.
- 3) Remember! How a company treats you now reflects how they will treat you if there's a problem. A quality electrical contractor listens to your problems, understands what you want accomplished and is willing to follow up after the work is completed.

STANDARD LIMITED THREE YEAR WARRANTY FOR L&L KILNS

THREE YEAR LIMITED KILN WARRANTY

L&L Kilns are warranted to be free of defects in workmanship for a period of three (3) years, starting on the date of original purchase from L&L Kiln Mfg., Inc. (L&L) or from an authorized L&L distributor or dealer, subject to the following terms and conditions, including but not limited to, the exclusions and limitations set forth herein.

- 1) A sales receipt is required for proof of purchase.
- 2) In addition, L&L may require you to deliver defective parts to L&L for examination to determine the applicability of these warranty provisions. DO NOT DISCARD PARTS BEFORE CONTACTING L&L FOR INSTRUCTIONS. FAILURE TO ADHERE TO L&L's INSTRUCTIONS, INCLUDING THOSE CONTAINED IN THE INSTRUCTION MANUAL AND AS STATED HEREIN, WILL VOID THIS WARRANTY.
- 3) L&L will replace or repair any defective part that is covered by this warranty and sent freight-prepaid to L&L. L&L will prepay return shipping cost without charge in the Continental United States.
- 4) On-site labor is not part of this warranty and is not covered by L&L. Any warranty labor provided by Dealers and Distributors is provided at their own discretion and expense.

APPLICATION

Applies to Easy-Fire, Easy-Fire XT, Jupiter, DaVinci, Easy-Load, Doll/Test, JH Series, Quad-Pro kilns, Fuego and Liberty-Belle kilns when used for non-industrial ceramics and glass.

EXCLUSIONS AND LIMITATIONS

The following are examples of items that are not covered by and/or circumstances that will void L&L's warranties:

- 1) **Use of elements and/or other parts other than genuine L&L Kiln parts.**
- 2) Kiln warranty may be voided by firing materials that introduce harmful atmospheres into the kiln. Atmospheres containing carbon, reducing atmospheres (caused, for example, by introducing carbonaceous gasses or solids like graphite or paper into the kiln), binders from lusters and decals, wax burn out effluents, fluorines, halogens, acids, metal oxides, and salts are some of the corrosive and harmful atmospheres that will damage a kiln. Most ceramic processes will release some of these harmful constituents

into the kiln and venting will prevent most of the problems that those processes would cause. Also, depending on the concentration of the harmful gasses, kiln source ventilation (such as our Vent-Sure) may limit the damage to the kiln. It is the customer's sole responsibility to ensure that the materials and the processes used are not harmful. This is of particular importance for industrial uses where processes may be unusual.

- 3) Over-firing damage for any reason and regardless of cause. **IMPORTANT: We specifically warn you not to fire the kiln unattended. Neither the Kiln Sitter, The Orton Sitter, the DynaTrol, One-Touch control, the Bartlett 3-Button control nor any other electronic control used by L&L is designed to be a failproof shut off device. L&L is not responsible for damage caused by failure of any of these controls.**

The Kiln Sitter, in particular, can be very unreliable because of the moving parts, dirt or clay that can get into the tube, the way cones are placed on the tube, corrosion, etc. DO NOT FIRE THIS KILN UNATTENDED WHEN THE KILN IS SUPPOSED TO TURN OFF AND LEARN HOW TO USE THE TIMER BACK UP. Neither L&L Kiln Mfg., Inc. nor Edward Orton Jr. Ceramic Foundation warranty the kiln or kiln sitter against damage caused by overfiring. We highly recommend firing all manual kilns with witness cones that you can see through the peephole and/or a pyrometer so you have some idea of what is happening inside the kiln.

Also note that it is easy to melt clay if you inadvertently fire it hotter than its rating. It is possible in some controls to limit the upper firing limit of the kiln to avoid accidental overfirings of this type. Contact factory or read your control instruction manual if you would like further information on this.

- 4) Firebrick by its nature is fragile and will chip, crack, and create dust. L&L designs its kilns to minimize the effects of this but can not warrant against cracking, breakage, spalling or dusting. There is specifically no warranty for cracked arches, tops, lids or bottoms.
- 5) Controls made by Orton (including the Orton Kiln Sitter), Eurotherm, Honeywell or other manufactures are warranted by their manufacturers. L&L is not responsible for damage caused by failure of one of these controls.
- 6) Corrosion of the case is specifically not warranted. Corrosion is typically due to use of a kiln in an unheated outside shed (where morning dew condenses on the kiln and humidity attacks the kiln) or from an unvented kiln (where the water vapor and fumes generated by firing ceramic materials attack the kiln case). However, even a vented kiln can corrode due to all the environmental and

STANDARD LIMITED THREE YEAR WARRANTY FOR L&L KILNS

process conditions that a kiln can be exposed to. Exposure to other ambient conditions, including but not limited to humidity, rain, snow, dust, and salt air will also cause corrosion.

7) Damage due to neglect, inadequate room or kiln ventilation, mechanical abuse, improper storage, inadequate maintenance, improper use or freight damage.

8) Damage to the elements or element holders due to failure to properly keep the kiln clean (i.e. allowing glaze or ceramic chards from exploding pots) to make contact with the element holders.

9) Damage to the kiln caused for firing in ambient conditions that are too hot for the control or other components in the kiln. The DynaTrol is rated for use up to 125°F (52°C). That means that the room that you fire in should be less than 110°F (43°C) (because the control will be slightly hotter than room air due to transferred heat from the kiln). Note that direct sunlight on the control face may raise the temperature of the board beyond what you would expect from the ambient temperature or the kiln heat. Also note that the DynaTrol specifically allows the operator to check the control board temperature.

10) Failure to report defect within fifteen (15) days after it becomes manifest or known.

11) Any alteration of parts or design that vary from factory designs.

12) Thermocouple Protection Tubes are not warranted against breakage.

13) L&L's warranty is strictly limited to repair or replacement of defective items. Kilns may not be returned.

14) Distributors and Dealers are not authorized by L&L to modify and/or assume any other obligations or liabilities other than those expressed in this limited warranty and any such additional obligations are null and void.

15) EXCEPT AS SPECIFICALLY WARRANTED HEREIN, KILNS ARE SOLD AS IS. L&L MAKES NO OTHER WARRANTY, EXPRESS OR IMPLIED, COVERING THE GOODS AND SPECIFICALLY DISCLAIMS ALL IMPLIED WARRANTIES OF MERCHANTABILITY OR FITNESS FOR A PARTICULAR PURPOSE. Purchaser acknowledges that certain conditions or circumstances may be created or incurred by Purchaser or user or over which L&L has no control, including, but not limited to, climactic conditions, improper use, inadequate maintenance, and Purchaser, as a condition of purchase or use, assumes responsibility for and releases L&L from liability arising out of the use of the kilns attributable to such causes.

16) L&L SHALL NOT BE LIABLE FOR ANY INCIDENTAL, SECONDARY, OR CONSEQUENTIAL DAMAGES, INCLUDING BUT NOT LIMITED TO BODILY INJURY OR DEATH, LOST PROFITS, LOSS OF USE, OR OTHER ECONOMIC LOSSES. Purchaser agrees that L&L's total liability for any damages or remedies arising hereunder shall be limited to direct damages, in an amount not exceeding the purchase price actually paid. Replacement or repair or refund, at L&L's sole discretion, of the purchase price of the equipment purchased shall constitute the exclusive and sole remedy available to Purchaser. Any action for breach of contract or negligence must be commenced by Purchaser within one (1) year after delivery of the equipment to Purchaser.

17) L&L's full Terms and Conditions of Sale are available at hotkilns.com/terms.

3 YEAR PRO-RATED ELEMENT & THERMOCOUPLE LIMITED WARRANTY

Elements and thermocouples are warranted for three (3) years on a pro-rated basis with the following exceptions:

1) Glaze damage to the elements caused by accidentally scraping edges of unfired glazed ware against element groove. WARNING: causing unfired glaze to contaminate element will damage elements and can lead to element failure, and creates a fire hazard.

2) Firing of kiln to a temperature that exceeds the lower of either the maximum rating of kiln or 2350°F (1290°C).

3) Damage to elements caused by explosion of ceramic object. WARNING: this may cause damage to the elements and can lead to element failure, and creates a fire hazard.

4) Elements are warranted on a prorated schedule based on the ship date of the kiln. All dates are based on ship date from factory if sold direct or drop shipped to customer. If sold from a distributor's warehouse the date would be based on when it was shipped and/or sold from the distributor. The warranty is not extended for any period of where operation of the kiln is delayed for shipping, warehousing, or other reasons.

5) This replacement schedule is limited to new kilns. L&L does not warrant replacement elements and thermocouples except for catastrophic failure (for instance, a situation where the element end broke off without fault of the operator).

6) Labor to replace elements is not covered.

STANDARD LIMITED THREE YEAR WARRANTY FOR L&L KILNS

7) The pro-rated discount schedule only is valid for elements that you are actually replacing. In other words you can't buy a whole set of elements at these prices for anticipated future replacement. We reserve the right to ask for replaced elements in return.

PRO-RATED SCHEDULE FOR MOST KILNS (THAT DO HAVE A VENT-SURE INSTALLED)

Date from time of shipment from factory	Price of thermocouples and elements
0-12 Months	No Charge
12-24 Months	25% of full list price
24-36 Months	50% of full list price

PRO-RATED SCHEDULE FOR JH SERIES KILNS AND FOR ALL KILNS THAT DO NOT HAVE A VENT-SURE INSTALLED

JH KILNS

The pro-rated schedule for elements for the JH series kilns varies because of the hard use these kilns get during the crystalline glaze firing process.

KILNS WITHOUT VENTS

In kilns used without an automatic Vent-Sure, the elements will corrode a lot quicker than normally and fail more quickly and this pro-rated schedule takes this into account.

Date from time of shipment from factory	Price of thermocouples and elements
0-6 Months	No Charge
6-12 Months	25% of full list price
12-24 Months	50% of full list price

3 YEAR LIMITED VENT WARRANTY

L&L VS-1 Vent-Sure is warranted to be free of defects in workmanship for a period of (3) years, starting from date of original purchase from L&L Kiln Mfg., Inc. or from an authorized L&L distributor or dealer. A sales receipt is required for proof of purchase. In addition, L&L may require you to send in defective parts for examination to determine the applicability of these warranty provisions. DO NOT DISCARD PARTS BEFORE CONTACTING L&L. L&L Kiln Mfg., Inc. will replace or repair any defective part sent freight-prepaid to L&L Kiln Mfg., Inc. following L&L's written acknowledgement and authorization regarding the specific issue. L&L Kiln Mfg., Inc. will prepay return shipping cost without charge in the Continental United States. On site labor is not covered by the factory; however, local distributors or dealers may offer this service.

EXCLUSIONS & LIMITATIONS

- 1) The Vent-Sure must be used as instructed in our vent instructions.
- 2) The use of any wax process that might cause condensation of wax or other similar substance in the vent system will void the warranty.
- 3) The Vent-Sure is not warranted to vent highly corrosive fumes, and any such use will void any warranties otherwise provided.

LIBERTY-BELLE INSTRUCTION MANUAL

PARTS



L&L Kiln's patented
hard ceramic
element holders
protect your kiln.

PARTS FOR ALL KILNS (ONLINE DATABASE)

PARTS LIST

A comprehensive and up-to-date listing of parts that pertain to all Kiln Series' built by L&L Kiln Mfg., Inc. can now be found on our website at,

hotkilns.com/parts

HOW TO SEARCH FOR PARTS

Use the "Kiln Series" Parts Filter to narrow down the list of available parts to those that pertain to your specific kiln.

Choose by Model Series (or Old Model Series): If you are unsure about what your kiln series is look at the serial number data nameplate on your kilns.

Choose by Search Name Contains: Note that the less text you use will yield more results.

Choose by Part Number (X-X-XXXX/XX): Fewer characters = more results. For instance put in M-A-____/___ and get every part number that starts with those letters.

Choose by Category: Pick the categories from the list as shown to the right.

DATA NAMEPLATE

This is a Data Nameplate that you will find on your kiln. Obtain the Serial Number, Model Number, Voltage, Phase, Amps and Watts and email to service@hotkilns.com for quicker better service.



Parts Filters

Kiln Series
<Any>

Old Kiln Series
<Any>

Search Name Contains
Apply

Part Number (X-X-XXXX/XX)
X-X-XXXX/XX Apply

Filter by Category

- Brick (Sides, Parts)
- Brick (Repair)
- Brick (Bottoms)
- Brick (Tops)
- Brick (Powered Bottoms)
- Insulation & Gaskets
- Ceramics (Element Holders)
- Ceramics (Peephole Plugs)
- Ceramics (Posts & Shelves)
- Controls (Digital)
- Controls (Thermocouples)
- Controls (Thermocouple Wire)
- Controls (Kiln Sitters)
- Controls (Manual Switches)
- Controls (Wired Panels)
- Elements
- Elements (Terminals)
- Instruction Manuals
- Kiln Sections (Powered)
- Kiln Sections (Unpowered)
- Labels
- Metal (Bell-Lift Parts)
- Metal (Control Boxes)
- Metal (Element Connect Boxes)
- Metal (Hardware)
- Metal (Hinge & Lid Parts)
- Metal (Metal Cases)
- Metal (Stands)
- Wiring (Bushings)
- Wiring (Control Wiring)
- Wiring (Fuses, Fuse Holders)
- Wiring (Wire Harnesses)
- Wiring (Cords)
- Wiring (Power Relays)
- Wiring (Power Blocks)
- Wiring (Power Wire)
- Wiring (Receptacles)
- Wiring (Switches)
- Wiring (Transformers)
- Wiring (Terminals)
- Vent System & Parts

LIBERTY-BELLE INSTRUCTION MANUAL

MSDS SHEETS

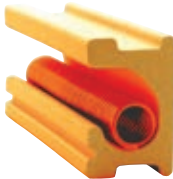

L&L Kiln's patented hard ceramic element holders protect your kiln.

L&L KILN COMPONENTS MATERIAL SAFETY DATA SHEETS

TABLE OF CONTENTS

STANDARD KILN COMPONENTS	2
KASIL® 6.....	2
REFRACTORY BRICK.....	7
REFRACTORY MORTAR.....	13
REPAIR KIT CEMENT	19
GREENSET-94-P.....	19
KILN WASH COMPONENTS	25
6-TILE KAOLIN CLAY	25
ALUMINUM HYDROXIDE.....	29
HALTEX® 315.....	33
KAOLIN SLURRY	35
SILICA SAND.....	41
ADDITIONAL INSULATION (DEPENDENT ON KILN).....	48
INSBLOK-19.....	48
INSULFRAX® INSULATION	55
ISOFRAX® 1260C PAPER.....	62
MINWOOL-1200™ BOARD	69
TADPOLE SILICA FABRIC	75
THERMO-12® GOLD INSULATION	87

Trade Name: **KASIL® 6 Potassium Silicate Solution**

Date Prepared: 07/26/06

Page: 1 of 5

1. CHEMICAL PRODUCT AND COMPANY IDENTIFICATION

Product name: **KASIL® 6 Potassium silicate solution**
Product description: **A 2.10 weight ratio potassium silicate, 39.2% solution in water**
Manufacturer: **PQ Corporation**
P. O. Box 840
Valley Forge, PA 19482 USA
Telephone: **610-651-4200**
In case of emergency call: **610-651-4200**
For transportation emergency
Call CHEMTREC: **800-424-9300**

2. COMPOSITION/INFORMATION ON INGREDIENTS

<i>Chemical and Common Name</i>	<i>CAS Registry Number</i>	<i>Wt. %</i>	<i>OSHA PEL</i>	<i>ACGIH TLV</i>
Water	7732-18-5	60.8%	Not Established	Not Established
Silicic acid, potassium salt; Potassium silicate	1312-76-1	39.2%	Not Established	Not Established

3. HAZARDS IDENTIFICATION

Emergency Overview: **Clear to hazy, colorless, odorless, thick liquid. Causes moderate eye irritation, slight skin irritation and digestive tract irritation. Spray mist causes irritation to respiratory tract. High pH of product is harmful to aquatic life. Noncombustible. Spills are slippery. Reacts with acids, ammonium salts, reactive metals and some organics.**

Eye contact: **Causes moderate irritation to the eyes.**

Skin contact: **Causes slight irritation to the skin.**

Inhalation: **Spray mist irritating to respiratory tract.**

Ingestion: **May cause irritation to mouth, esophagus, and stomach.**

Chronic hazards: **No known chronic hazards. Not listed by NTP, IARC or OSHA as a carcinogen.**

Physical hazards: **Dries to form glass film which can easily cut skin. Spilled material is very slippery. Can etch glass if not promptly removed.**

4. FIRST AID MEASURES

Eye: **In case of contact, immediately flush eyes with plenty of water for at least 15 minutes. Get medical attention.**

Skin: **In case of contact, immediately flush skin with plenty of water. Remove contaminated clothing and shoes. Get medical attention.**

Inhalation: **Remove to fresh air. If not breathing, give artificial respiration. If breathing is difficult, give oxygen. Get medical attention.**

Trade Name: **KASIL[®] 6 Potassium Silicate Solution**
Date Prepared: 07/26/06

Page: 2 of 5

Ingestion: If swallowed, **DO NOT** induce vomiting. Get medical attention immediately. If victim is fully conscious, give a cupful of water. Never give anything by mouth to an unconscious person.

5. FIRE FIGHTING MEASURES

Flammable limits: This material is noncombustible.
Extinguishing Media: This material is compatible with all extinguishing media.
Hazards to fire-fighters: See Section 3 for information on hazards when this material is present in the area of a fire.
Fire-fighting equipment: The following protective equipment for fire fighters is recommended when this material is present in the area of a fire: chemical goggles, body-covering protective clothing, chemical resistant gloves, and rubber boots.

6. ACCIDENTAL RELEASE MEASURES

Personal protection: Wear chemical goggles, body-covering protective clothing, chemical resistant gloves, and rubber boots. See section 8.
Environmental Hazards: Sinks and mixes with water. High pH of this material is harmful to aquatic life, see Section 12. Only water will evaporate from a spill of this material.
Small spill cleanup: Mop up and neutralize liquid, then discharge to sewer in accordance with federal, state and local regulations or permits.
Large spill cleanup: Keep unnecessary people away; isolate hazard area and deny entry. Do not touch or walk through spilled material. Stop leak if you can do so without risk. Prevent runoff from entering into storm sewers and ditches which lead to natural waterways. Isolate, dike and store discharged material, if possible. Use sand or earth to contain spilled material. If containment is impossible, neutralize contaminated area and flush with large quantities of water.
CERCLA RQ: There is no CERCLA Reportable Quantity for this material. If a spill goes off site, notification of state and local authorities is recommended.

7. HANDLING AND STORAGE

Handling: Avoid contact with eyes, skin and clothing. Avoid breathing spray mist. Keep container closed. Promptly clean residue from closures with cloth dampened with water. Promptly clean up spills.
Storage: Keep containers closed. Store in clean steel or plastic containers. Separate from acids, reactive metals, and ammonium salts. Storage temperature 0-95° C. Loading temperature 45-95 ° C. Do not store in aluminum, fiberglass, copper, brass, zinc or galvanized containers.

8. EXPOSURE CONTROLS/PERSONAL PROTECTION

Engineering controls: Use with adequate ventilation. Keep containers closed. Safety shower and eyewash fountain should be within direct access.

Respiratory protection: Use a NIOSH-approved dust and mist respirator where spray mist occurs. Observe OSHA regulations for respirator use (29 C.F.R. §1910.134)

Skin protection: Wear body-covering protective clothing and gloves.

Eye protection: Wear chemical goggles.

9. PHYSICAL AND CHEMICAL PROPERTIES

Appearance: Thick liquid.

Color: Clear to hazy white.

Odor: Odorless or musty odor.

pH: Approximately 11.7

Specific gravity: 1.39 g/cm₃ (20°C), 40.4° Bé, 11.56 lbs/gal

Solubility in water: Miscible.

10. STABILITY AND REACTIVITY

Stability: This material is stable under all conditions of use and storage.

Conditions to avoid: None.

Materials to avoid: Gels and generates heat when mixed with acid. May react with ammonium salts resulting in evolution of ammonia gas. Flammable hydrogen gas may be produced on contact with aluminum, tin, lead, and zinc.

Hazardous decomposition products: Hydrogen.

11. TOXICOLOGICAL INFORMATION

Acute Data: When tested for primary irritation potential, this material caused moderate irritation to the eyes and slight irritation to the skin. Human experience indicates that irritation occurs when potassium silicates get on clothes at the collar, cuffs or other areas where abrasion may occur. The acute oral toxicity of this product has not been tested. When chemically similar sodium silicates were tested on a 100% solids basis, their single dose acute oral LD₅₀ in rats ranged from 1500 mg/kg to 3200 mg/kg. The acute oral lethality resulted from nonspecific causes. This product contains approximately 39.2% potassium silicate.

Subchronic Data: The subchronic toxicity of this material has not been tested. In a study of rats fed chemically similar sodium silicate in drinking water for three months, at 200, 600 and 1800 ppm, changes were reported in the blood chemistry of some animals, but no specific changes to the organs of the animals due to potassium silicate administration were observed in any of the dosage groups. Another study reported adverse effects to the kidneys of dogs fed potassium silicate in their diet at 2.4g/kg/day for 4 weeks,

Special Studies: whereas rats fed the same dosage did not develop any treatment-related effects. Decreased numbers of births and survival to weaning was reported for rats fed sodium silicate in their drinking water at 600 and 1200 ppm.
The mutagenic potential of this material has not been tested. Chemically similar sodium silicate was not mutagenic to the bacterium E. Coli when tested in a mutagenicity bioassay. There are no known reports of carcinogenicity of potassium silicates. Frequent ingestion over extended periods of time of gram quantities of silicates is associated with the formation kidney stones and other siliceous urinary calculi in humans. Potassium silicate is not listed by IARC, NTP or OSHA as a carcinogen.

12. ECOLOGICAL INFORMATION

Ecotoxicity: The ecotoxicity of potassium silicate has not been tested. The following data is reported for chemically similar sodium silicates on a 100% solids basis: A 96 hour median tolerance for fish (*Gambusia affinis*) of 2320 ppm; a 96 hour median tolerance for water fleas (*Daphnia magna*) of 247 ppm; a 96 hour median tolerance for snail eggs (*Lymnea*) of 632 ppm; and a 96 hour median tolerance for Amphipoda of 160 ppm. This product contains approximately 39.2% potassium silicate.

Environmental Fate: This material is not persistent in aquatic systems, but its high pH when undiluted or unneutralized is acutely harmful to aquatic life. Diluted material rapidly depolymerizes to yield dissolved silica in a form that is indistinguishable from natural dissolved silica. It does not contribute to BOD. This material does not bioaccumulate except in species that use silica as a structural material such as diatoms and siliceous sponges. Where abnormally low natural silica concentrations exist (less than 0.1 ppm), dissolved silica may be a limiting nutrient for diatoms and a few other aquatic algal species. However, the addition of excess dissolved silica over the limiting concentration will not stimulate the growth of diatom populations; their growth rate is independent of silica concentration once the limiting concentration is exceeded. Neither silica nor potassium will appreciably bioconcentrate up the food chain.

Physical/Chemical: Sinks and mixes with water. Only water will evaporate from this material.

13. DISPOSAL CONSIDERATIONS

Classification: Disposed material is not a RCRA Hazardous waste.
Disposal Method: Dispose in accordance with federal, state and local regulations and permits.

14. TRANSPORT INFORMATION

DOT UN Status: This material is not regulated hazardous material for transportation.

Trade Name: **KASIL[®] 6 Potassium Silicate Solution**
Date Prepared: 07/26/06

Page: 5 of 5

15. REGULATORY INFORMATION

CERCLA: No CERCLA Reportable Quantity has been established for this material.
SARA TITLE III: Not an Extremely Hazardous Substance under §302. Not a Toxic Chemical under §313. Hazard Categories under §§311/312: Acute
TSCA: All ingredients of this material are listed on the TSCA inventory.
FDA: Potassium silicate is regarded as GRAS (Generally Recognized As Safe) as a corrosion preventative in potable water.

16. OTHER INFORMATION

Prepared by: John G. Blumberg
Supersedes revision of: 03/24/06

THE INFORMATION ON THIS SAFETY DATA SHEET IS BELIEVED TO BE ACCURATE AND IT IS THE BEST INFORMATION AVAILABLE TO PQ CORPORATION THIS DOCUMENT IS INTENDED ONLY AS A GUIDE TO THE APPROPRIATE PRECAUTIONS FOR HANDLING A CHEMICAL BY A PERSON TRAINED IN CHEMICAL HANDLING. PQ CORPORATION MAKES NO WARRANTY OF MERCHANTABILITY OR ANY OTHER WARRANTY, EXPRESS OR IMPLIED WITH RESPECT TO SUCH INFORMATION OR THE PRODUCT TO WHICH IT RELATES, AND WE ASSUME NO LIABILITY RESULTING FROM THE USE OR HANDLING OF THE PRODUCT TO WHICH THIS SAFETY DATA SHEET RELATES. USERS AND HANDLERS OF THIS PRODUCT SHOULD MAKE THEIR OWN INVESTIGATIONS TO DETERMINE THE SUITABILITY OF THE INFORMATION PROVIDED HEREIN FOR THEIR OWN PURPOSES.



MATERIAL SAFETY DATA SHEET

MSDS No: 151-1

Date Prepared: 03/28/1995

Current Date: 9/14/2007

Last Revised: (09/14/2007)

1. PRODUCT AND COMPANY IDENTIFICATION

Product Group: INSULATING REFRACTORY BRICK
Chemical Name: Aluminosilicate Product
Intended Use: High Temperature Thermal Insulation
Trade Names: K-20, K-22 HS, K-23, JM-20, JM-23, K-24 HS, K-25, K-26, IFB Dust (Low Temp), TC-23, TC-23 HS

Manufacturer/Supplier: Thermal Ceramics Inc.
 P. O. Box 923; Dept. 300
 Augusta, GA 30903-0923

For Product Stewardship and Emergency Information -
 Hotline: 1-800-722-5681
 Fax: 706-560-4054

For additional MSDSs and to confirm this is the most current MSDS for the product, visit our web page [www.thermalceramics.com]

2. COMPOSITION/INFORMATION ON INGREDIENTS

<u>INGREDIENT & CAS NUMBER</u>	<u>% BY WEIGHT</u>	<u>OSHA PEL</u>	<u>ACGIH TLV</u>
Anorthite NONE	Up to 70	15 mg/m ³ (total dust) 5 mg/m ³ (respirable dust)	10 mg/m ³ (inhalable dust) 3 mg/m ³ (respirable dust)
Glass 65997-17-3	Up to 30	15 mg/m ³ (total dust) 5 mg/m ³ (respirable dust)	10 mg/m ³ (inhalable dust) 3 mg/m ³ (respirable dust)
Mullite 1344-28-1	Up to 20	15 mg/m ³ (total dust) 5 mg/m ³ (respirable dust)	10 mg/m ³ (inhalable dust) 3 mg/m ³ (respirable dust)
Crystalline silica 14808-60-7 or 14464-46-1	Up to 5	See notes ⁽¹⁾	0.05 mg/m ³ (respirable dust)

NOTES:

⁽¹⁾ Depending on the percentage and type(s) of silica in the mineral, the OSHA Permissible Exposure Limit (PEL) for respirable dust containing crystalline silica (8 HR TWA) is based on the formula listed in 29 CFR 1910.1000, "Air Contaminants" under Table Z-3, "Mineral Dust". For quartz containing mineral dust, the PEL = 10 mg/m³ / (% of silica + 2); for cristobalite or tridymite, the PEL = 5 mg/m³ / (% of silica + 2); for mixtures, the PEL = 10 mg/m³ / (% of quartz + 2 (% of cristobalite) + 2 (% of tridymite) + 2).

(See Section 8 "Exposure Controls / Personal Protection" for exposure guidelines.)

MSDS No: 151-1

Date Prepared: 03/28/1995

Current Date: 9/14/2007

Last Revised: (09/14/2007)

3. HAZARDS IDENTIFICATION

EMERGENCY OVERVIEW

WARNING!

Respirable dust from these products may contain crystalline silica, which is known to cause respiratory disease.
(See Section 11 for more information)

POSSIBLE HEALTH EFFECTS

Target Organs: Eyes, skin, nose and/or throat

Primary Entry Route: Inhalation

Acute effects: May cause temporary, mild mechanical irritation to the eyes, skin, nose and/or throat. Pre-existing skin and respiratory conditions may be aggravated by exposure.

Chronic effects: Prolonged/repeated inhalation of respirable crystalline silica may cause delayed lung injury (e.g.: silicosis, lung cancer).

HAZARD CLASSIFICATION

Dust samples from these products have not been tested for their specific toxicity, but may contain more than 0.1% crystalline silica, for which the following apply:

The **International Agency for Research on Cancer (IARC)** has classified crystalline silica inhaled in the form of quartz or cristobalite from occupational sources as carcinogenic to humans (Group 1).

The Ninth Annual Report on Carcinogens (2000), prepared by the **National Toxicology Program (NTP)**, classified silica, crystalline (respirable size), as a substance known to be a human carcinogen.

The **American Conference of Governmental Industrial Hygienists (ACGIH)** has classified crystalline silica (quartz) as "A2-Suspected Human Carcinogen."

The **State of California**, pursuant to Proposition 65, The Safe Drinking Water and Toxic Enforcement Act of 1986, has listed "silica, crystalline (airborne particles of respirable size)" as a chemical known to the State of California to cause cancer.

The **Canadian Workplace Hazardous Materials Information System (WHMIS)** – Crystalline silica [quartz and cristobalite] is classified as Class D2A - Materials Causing Other Toxic Effects.

The **Hazardous Materials Identification System (HMIS)** –

Health: 0* Flammability: 0 Reactivity: 0 Personal Protection Index: X (Employer determined)

(* denotes potential for chronic effects)

4. FIRST AID MEASURES

EYE IRRITATION:

Flush with large amounts of water for at least 15 minutes. Do not rub eyes.

SKIN IRRITATION:

Wash affected area gently with soap and water. Skin cream or lotion after washing may be helpful.

INGESTION:

Unlikely route of exposure.

INHALATION:

Remove affected person to dust free location. See Section 8 for additional measures to reduce or eliminate exposure.

- If symptoms persist, seek medical attention. -

MSDS No: 151-1

Date Prepared: 03/28/1995

Current Date: 9/14/2007

Last Revised: (09/14/2007)

5. FIRE FIGHTING MEASURES

NFPA CODES: Flammability: 0, Health: 1, Reactivity: 0, Special: 0
NFPA Unusual Hazards: None
Flash Point: None
Extinguishing Media: Use extinguishing media suitable for type of surrounding fire.
Explosion Hazards: None
Hazardous Decomposition Products: None

6. ACCIDENTAL RELEASE MEASURES

SPILL/LEAK PROCEDURES:

Avoid creating airborne dust. Follow routine housekeeping procedures. Vacuum only with HEPA filtered equipment. If sweeping is necessary, use a dust suppressant and place material in closed containers. Do not use compressed air for clean-up. Personnel should wear gloves, goggles and approved respirator.

7. HANDLING AND STORAGE

HANDLING

Limit the use of power tools unless in conjunction with local exhaust. Use hand tools whenever possible. Frequently clean the work area with HEPA filtered vacuum or wet sweeping to minimize the accumulation of debris. Do not use compressed air for clean-up.

STORAGE

Store in original factory container in a dry area. Keep container closed when not in use.

EMPTY CONTAINERS

Product packaging may contain residue. Do not reuse.

8. EXPOSURE CONTROLS/PERSONAL PROTECTION

ENGINEERING CONTROLS

Use engineering controls, such as ventilation and dust collection devices, to reduce airborne particulate concentrations to the lowest attainable level.

RESPIRATORY PROTECTION

When it is not possible or feasible to reduce airborne crystalline silica or particulate levels below the PEL through engineering controls, or until they are installed, employees are encouraged to use good work practices together with respiratory protection. Before providing respirators to employees (especially negative pressure type), employers should **1) monitor for airborne crystalline silica and/or dust concentrations using appropriate NIOSH analytical methods and select respiratory protection based upon the results of that monitoring,** **2) have the workers evaluated by a physician to determine the workers' ability to wear respirators, and 3) implement respiratory protection training programs.** Use NIOSH-certified particulate respirators (42 CFR 84), in compliance with OSHA Respiratory Protection Standard 29 CFR 1910.134 and 29 CFR 1926.103, for the particular hazard or airborne concentrations to be encountered in the work environment. For the most current information on respirator selection, contact your supplier.

PROTECTIVE CLOTHING

Wear full body clothing, gloves, hat, and eye protection as necessary to prevent skin irritation. Washable or disposable clothing may be used. If possible, do not take unwashed work clothing home. If soiled work clothing must be taken home, employers should ensure employees are trained on the best practices to minimize or avoid non-work dust exposure (e.g., vacuum clothes before leaving the work area, wash work clothing separately, rinse washer before washing other household clothes, etc.).

EYE PROTECTION

MSDS No: 151-1

Date Prepared: 03/28/1995

Current Date: 9/14/2007

Last Revised: (09/14/2007)

Wear safety glasses with side shields or other forms of eye protection in compliance with appropriate OSHA standards to prevent eye irritation. The use of contact lenses is not recommended, unless used in conjunction with appropriate eye protection. Do not touch eyes with soiled body parts or materials. If possible, have eye-washing facilities readily available where eye irritation can occur.

9. PHYSICAL AND CHEMICAL PROPERTIES

ODOR AND APPEARANCE:	Solid brick or block
CHEMICAL FAMILY:	Insulating refractory brick
BOILING POINT:	Not applicable
WATER SOLUBILITY (%):	Not soluble in water
MELTING POINT:	2750°F to 2800°F
SPECIFIC GRAVITY:	Not applicable
VAPOR PRESSURE:	Not applicable
pH:	Not applicable
VAPOR DENSITY:	Not applicable
VOLATILE BY VOLUME (%):	Not applicable
MOLECULAR FORMULA:	Not Applicable

10. STABILITY AND REACTIVITY

HAZARDOUS POLYMERIZATION:	Will not occur
CHEMICAL INCOMPATIBILITIES:	Powerful oxidizers; fluorine, manganese trioxide, oxygen disulfide
HAZARDOUS DECOMPOSITION PRODUCTS:	None

11. TOXICOLOGICAL INFORMATION

TOXICOLOGY

Dust samples from these products have not been tested. They may contain respirable crystalline silica.

Crystalline silica

Some samples of crystalline silica administered to rats by inhalation and intratracheal instillation have caused fibrosis and lung cancer. Mice and hamsters, similarly exposed, develop inflammatory disease including fibrosis but no lung cancer.

EPIDEMIOLOGY

No studies have been undertaken on humans exposed to these products in occupational environments.

Crystalline silica

Exposure to crystalline silica can cause silicosis, and exacerbate pulmonary tuberculosis and bronchitis. IARC (Monograph vol. 68, 1997) concluded that "crystalline silica from occupational sources inhaled in the form of quartz or cristobalite is carcinogenic to humans (Group 1)", and noted that "carcinogenicity in humans was not detected in all industrial circumstances studied" and "may be dependent on inherent characteristics of the crystalline silica or on external factors affecting its biological activity".

12. ECOLOGICAL INFORMATION

Adverse effects of this material on the environment are not anticipated.

MSDS No: 151-1

Date Prepared: 03/28/1995

Current Date: 9/14/2007

Last Revised: (09/14/2007)

13. DISPOSAL INFORMATION

WASTE MANAGEMENT

To prevent waste materials becoming airborne during waste storage, transportation and disposal, a covered container or plastic bagging is recommended. Comply with federal, state and local regulations.

DISPOSAL

If discarded in its purchased form, this product would not be a hazardous waste under Federal regulations (40 CFR 261). Any processing, use, alteration or chemical additions to the product, as purchased, may alter the disposal requirements. Under Federal regulations, it is the waste generator's responsibility to properly characterize a waste material, to determine if it is a hazardous waste. Check local, regional, state or provincial regulations to identify all applicable disposal requirements.

14. TRANSPORT INFORMATION

U.S. DEPARTMENT OF TRANSPORTATION (DOT)

Hazard Class:	Not Regulated	United Nations (UN) Number:	Not Applicable
Labels:	Not Applicable	North America (NA) Number:	Not Applicable
Placards:	Not Applicable	Bill of Lading:	Product Name

INTERNATIONAL

Canadian TDG Hazard Class & PIN: Not regulated
Not classified as dangerous goods under ADR (road), RID (train) or IMDG (ship).

15. REGULATORY INFORMATION

UNITED STATES REGULATIONS

SARA Title III: This product does not contain any substances reportable under Sections 302, 304, 313 (40 CFR 372). Sections 311 and 312 apply.

OSHA: Comply with Hazard Communication Standards 29 CFR 1910.1200 and 29 CFR 1926.59 and Respiratory Protection Standards 29 CFR 1910.134 and 29 CFR 1926.103.

TSCA: All substances contained in this product are listed in the TSCA Chemical Inventory

California: "Silica, crystalline (airborne particles of respirable size)" is listed in Proposition 65, The Safe Drinking Water and Toxic Enforcement Act of 1986 as a chemical known to the State of California to cause cancer.

Other States: Crystalline silica products are not known to be regulated by states other than California; however, state and local OSHA and EPA regulations may apply to these products. Contact your local agency if in doubt.

INTERNATIONAL REGULATIONS

Canadian WHMIS: Class D-2A Materials Causing Other Toxic Effects

Canadian EPA: All substances in this product are listed, as required, on the Domestic Substance List (DSL).

16. OTHER INFORMATION

SARA TITLE III HAZARD CATEGORIES

Acute Health:	No	Pressure Hazard:	No
Chronic Health:	Yes	Reactivity Hazard:	No
Fire Hazard:	No		

MSDS No: 151-1**Date Prepared: 03/28/1995****Current Date: 9/14/2007****Last Revised: (09/14/2007)****DEFINITIONS:**

ACGIH:	American Conference of Governmental Industrial Hygienists
ADR:	Carriage of Dangerous Goods by Road (International Regulation)
CAA:	Clean Air Act
CAS:	Chemical Abstracts Service Registry Number
CERCLA:	Comprehensive Environmental Response, Compensation and Liability Act
EPA:	Environmental Protection Agency
EU:	European Union
f/cc:	Fibers per cubic centimeter
HEPA:	High Efficiency Particulate Air
HMIS:	Hazardous Materials Identification System
IARC:	International Agency for Research on Cancer
IATA:	International Air Transport Association
IMDG:	International Maritime Dangerous Goods Code
mg/m³:	Milligrams per cubic meter of air
mppcf:	Million particles per cubic meter
MSHA:	Mine Safety and Health Administration
NFPA:	National Fire Protection Association
NIOSH:	National Institute for Occupational Safety and Health
OSHA:	Occupational Safety and Health Administration
PEL:	Permissible Exposure Limit
PNOC:	Particulates Not Otherwise Classified
PNOR:	Particulates Not Otherwise Regulated
RCRA:	Resource Conservation and Recovery Act
RID:	Carriage of Dangerous Goods by Rail (International Regulation)
SARA:	Superfund Amendments and Reauthorization Act
Title III:	Emergency Planning and Community Right to Know Act
...Section 302:	Extremely Hazardous Substances
...Section 304:	Emergency Release
...Section 311:	MSDS/List of Chemicals
...Section 312:	Emergency and Hazardous Inventory
...Section 313:	Toxic Chemicals Release Reporting
STEL:	Short-Term Exposure Limit
TCLP:	Toxicity Characteristics Leaching Procedures (EPA)
TLV:	Threshold Limit Values (ACGIH)
TSCA:	Toxic Substance Control Act
WHMIS:	Workplace Hazardous Materials Information System (Canada)
29 CFR 1910.134 & 1926.103:	OSHA Respiratory Protection Standards
29 CFR 1910.1200 & 1926.59:	OSHA Hazard Communication Standards

Revision Summary: MSDS revision date updated.**MSDS Prepared By:** THERMAL CERAMICS ENVIRONMENTAL, HEALTH & SAFETY DEPARTMENT**DISCLAIMER**

The information presented herein is presented in good faith and believed to be accurate as of the effective date of this Material Safety Data Sheet. Employers may use this MSDS to supplement other information gathered by them in their efforts to assure the health and safety of their employees and the proper use of the product. This summary of the relevant data reflects professional judgment; employers should note that information perceived to be less relevant has not been included in this MSDS. Therefore, given the summary nature of this document, Thermal Ceramics does not extend any warranty (expressed or implied), assume any responsibility, or make any representation regarding the completeness of this information or its suitability for the purposes envisioned by the user.



MATERIAL SAFETY DATA SHEET

MSDS No: 141

Date Prepared: 05/01/1987

Current Date: 4/12/2006

Last Revised: (04/10/2006)

1. PRODUCT AND COMPANY IDENTIFICATION

Product Group: REFRACTORY MORTAR
Chemical Name: Aluminosilicate Product
Intended Use: High Temperature Thermal Insulation
Trade Names: Air-Set™ (Dry, Wet); Smooth-Set (Dry, Wet); High Temp: IFB (Dry, Wet); SR®-90 Dry; Mul-Set™ F (Dry, Wet); Unistik® A; K®-Bond (Dry, Wet); Cements; Cer-Flex® Mortars

Manufacturer/Supplier: Thermal Ceramics Inc.
P. O. Box 923; Dept. 300
Augusta, GA 30903-0923

For Product Stewardship and Emergency Information -
Hotline: 1-800-722-5681
Fax: 706-560-4054

For additional MSDSs and to confirm this is the most current MSDS for the product, visit our web page [www.thermalceramics.com].

2. COMPOSITION/INFORMATION ON INGREDIENTS

<u>INGREDIENT & CAS NUMBER</u>	<u>% BY WEIGHT</u>	<u>OSHA PEL</u>	<u>ACGIH TLV</u>
Aluminum silicate 1302-76-7	Up to 52	15 mg/m ³ (total dust); 5 mg/m ³ (respirable dust)	10 mg/m ³ (inhalable dust) 3 mg/m ³ (respirable dust)
Aluminum oxide 1344-28-1	Up to 50	15 mg/m ³ (total dust); 5 mg/m ³ (respirable dust)	10 mg/m ³
Silica, amorphous 7631-86-9	Up to 40	(80 mg/m ³ ÷ % SiO ₂) or 20 mppcf	10 mg/m ³
Kaolin 1332-58-7	Up to 27	15 mg/m ³	2 mg/m ³ (respirable dust)
Crystalline silica 14808-60-7 or 14464-46-1	Up to 20	See notes ⁽¹⁾	0.05 mg/m ³ (respirable dust)
Water 7732-18-5	0 to 11	Not established	Not established
Borate, tetra, sodium salt, decahydrate 1303-96-4	0 to 2	15 mg/m ³ (total dust); 5 mg/m ³ (respirable dust)	5 mg/m ³

MSDS No: 141

Date Prepared: 05/01/1987

Current Date: 4/12/2006

Last Revised: (04/10/2006)

NOTES:

⁽¹⁾ Depending on the percentage and type(s) of silica in the mineral, the OSHA Permissible Exposure Limit (PEL) for respirable dust containing crystalline silica (8 HR TWA) is based on the formula listed in 29 CFR 1910.1000, "Air Contaminants" under Table Z-3, "Mineral Dust". For quartz containing mineral dust, the PEL = 10 mg/m³ / (% of silica + 2); for cristobalite or tridymite, the PEL = 5 mg/m³ / (% of silica + 2); for mixtures, the PEL = 10 mg/m³ / (% of quartz + 2 (% of cristobalite) + 2 (% of tridymite) + 2).

(See Section 8 "Exposure Controls / Personal Protection" for exposure guidelines.)

3. HAZARDS IDENTIFICATION

EMERGENCY OVERVIEW

WARNING!

Respirable dust from these products may contain crystalline silica, which is known to cause respiratory disease.
(See Section 11 for more information)

POSSIBLE HEALTH EFFECTS

Target Organs: Eyes, skin, nose and/or throat
Primary Entry Route: Inhalation
Acute effects: May cause temporary, mild mechanical irritation to the eyes, skin, nose and/or throat. Pre-existing skin and respiratory conditions may be aggravated by exposure.
Chronic effects: Prolonged/repeated inhalation of respirable crystalline silica may cause delayed lung injury (e.g.: silicosis, lung cancer).

HAZARD CLASSIFICATION

Dust samples from these products have not been tested for their specific toxicity, but may contain more than 0.1% crystalline silica, for which the following apply:

The **International Agency for Research on Cancer (IARC)** has classified crystalline silica inhaled in the form of quartz or cristobalite from occupational sources as carcinogenic to humans (Group 1).

The Ninth Annual Report on Carcinogens (2000), prepared by the **National Toxicology Program (NTP)**, classified silica, crystalline (respirable size), as a substance known to be a human carcinogen.

The **American Conference of Governmental Industrial Hygienists (ACGIH)** has classified crystalline silica (quartz) as "A2-Suspected Human Carcinogen."

The **State of California**, pursuant to Proposition 65, The Safe Drinking Water and Toxic Enforcement Act of 1986, has listed "silica, crystalline (airborne particles of respirable size)" as a chemical known to the State of California to cause cancer.

The **Canadian Workplace Hazardous Materials Information System (WHMIS)** – Crystalline silica [quartz and cristobalite] is classified as Class D2A - Materials Causing Other Toxic Effects.

The **Hazardous Materials Identification System (HMIS)** –
Health: 1* Flammability: 0 Reactivity: 0 Personal Protection Index: X (Employer determined)
(* denotes potential for chronic effects)

4. FIRST AID MEASURES

EYE IRRITATION:

Flush with large amounts of water for at least 15 minutes. Do not rub eyes.

SKIN IRRITATION:

Wash affected area gently with soap and water. Skin cream or lotion after washing may be helpful.

MSDS No: 141

Date Prepared: 05/01/1987

Current Date: 4/12/2006

Last Revised: (04/10/2006)

INGESTION:

Unlikely route of exposure.

INHALATION:

Remove affected person to dust free location. See Section 8 for additional measures to reduce or eliminate exposure.

- If symptoms persist, seek medical attention. -

5. FIRE FIGHTING MEASURES

NFPA CODES: Flammability: 0, Health: 1, Reactivity: 0, Special: 0

NFPA Unusual Hazards: None

Flash Point: None

Extinguishing Media: Use extinguishing media suitable for type of surrounding fire.

Explosion Hazards: None

Hazardous Decomposition Products: None

6. ACCIDENTAL RELEASE MEASURES

SPILL/LEAK PROCEDURES:

Avoid creating airborne dust. Follow routine housekeeping procedures. Vacuum only with HEPA filtered equipment. If sweeping is necessary, use a dust suppressant and place material in closed containers. Do not use compressed air for clean-up. Personnel should wear gloves, goggles and approved respirator.

7. HANDLING AND STORAGE

HANDLING

Limit the use of power tools unless in conjunction with local exhaust. Use hand tools whenever possible. Frequently clean the work area with HEPA filtered vacuum or wet sweeping to minimize the accumulation of debris. Do not use compressed air for clean-up.

STORAGE

Store in original factory container in a dry area. Keep container closed when not in use.

EMPTY CONTAINERS

Product packaging may contain residue. Do not reuse.

8. EXPOSURE CONTROLS/PERSONAL PROTECTION

ENGINEERING CONTROLS

Use engineering controls, such as ventilation and dust collection devices, to reduce airborne particulate concentrations to the lowest attainable level.

RESPIRATORY PROTECTION

When it is not possible or feasible to reduce airborne crystalline silica or particulate levels below the PEL through engineering controls, or until they are installed, employees are encouraged to use good work practices together with respiratory protection. Before providing respirators to employees (especially negative pressure type), employers should **1) monitor for airborne crystalline silica and/or dust concentrations using appropriate NIOSH analytical methods and select respiratory protection based upon the results of that monitoring,** **2) have the workers evaluated by a physician to determine the workers' ability to wear respirators, and 3) implement respiratory protection training programs.** Use NIOSH-certified particulate respirators (42 CFR 84), in compliance with OSHA Respiratory Protection Standard 29 CFR 1910.134 and 29 CFR 1926.103, for the particular hazard or airborne concentrations to be encountered in the work environment. For the most current information on respirator selection, contact your supplier.

MSDS No: 141

Date Prepared: 05/01/1987

Current Date: 4/12/2006

Last Revised: (04/10/2006)

PROTECTIVE CLOTHING

Wear full body clothing, gloves, hat, and eye protection as necessary to prevent skin irritation. Washable or disposable clothing may be used. If possible, do not take unwashed work clothing home. If soiled work clothing must be taken home, employers should ensure employees are trained on the best practices to minimize or avoid non-work dust exposure (e.g., vacuum clothes before leaving the work area, wash work clothing separately, rinse washer before washing other household clothes, etc.).

EYE PROTECTION

Wear safety glasses with side shields or other forms of eye protection in compliance with appropriate OSHA standards to prevent eye irritation. The use of contact lenses is not recommended, unless used in conjunction with appropriate eye protection. Do not touch eyes with soiled body parts or materials. If possible, have eye-washing facilities readily available where eye irritation can occur.

9. PHYSICAL AND CHEMICAL PROPERTIES

ODOR AND APPEARANCE:	Concrete like material
CHEMICAL FAMILY:	Refractory mortar
BOILING POINT:	Not applicable
WATER SOLUBILITY (%):	Not soluble in water
MELTING POINT:	Up to 3200°F (depending on the product)
SPECIFIC GRAVITY:	Not applicable
VAPOR PRESSURE:	Not applicable
pH:	Not applicable
VAPOR DENSITY:	Not applicable
VOLATILE BY VOLUME (%):	Not applicable
MOLECULAR FORMULA:	Not Applicable

10. STABILITY AND REACTIVITY

HAZARDOUS POLYMERIZATION:	Will not occur
CHEMICAL INCOMPATIBILITIES:	Powerful oxidizers; fluorine, manganese trioxide, oxygen disulfide
HAZARDOUS DECOMPOSITION PRODUCTS:	None

11. TOXICOLOGICAL INFORMATION

TOXICOLOGY

Dust samples from these products have not been tested. They may contain respirable crystalline silica.

Crystalline silica

Some samples of crystalline silica administered to rats by inhalation and intratracheal instillation have caused fibrosis and lung cancer. Mice and hamsters, similarly exposed, develop inflammatory disease including fibrosis but no lung cancer.

EPIDEMIOLOGY

No studies have been undertaken on humans exposed to these products in occupational environments.

Crystalline silica

Exposure to crystalline silica can cause silicosis, and exacerbate pulmonary tuberculosis and bronchitis. IARC (Monograph vol. 68, 1997) concluded that "crystalline silica from occupational sources inhaled in the form of quartz or cristobalite is carcinogenic to humans (Group 1)", and noted that "carcinogenicity in humans was not detected in all industrial circumstances studied" and "may be dependent on inherent characteristics of the crystalline silica or on external factors affecting its biological activity".

MSDS No: 141

Date Prepared: 05/01/1987

Current Date: 4/12/2006

Last Revised: (04/10/2006)

12. ECOLOGICAL INFORMATION

Adverse effects of this material on the environment are not anticipated.

13. DISPOSAL INFORMATION

WASTE MANAGEMENT

To prevent waste materials becoming airborne during waste storage, transportation and disposal, a covered container or plastic bagging is recommended. Comply with federal, state and local regulations.

DISPOSAL

If discarded in its purchased form, this product would not be a hazardous waste under Federal regulations (40 CFR 261) Any processing, use, alteration or chemical additions to the product, as purchased, may alter the disposal requirements. Under Federal regulations, it is the waste generator's responsibility to properly characterize a waste material, to determine if it is a hazardous waste. Check local, regional, state or provincial regulations to identify all applicable disposal requirements.

14. TRANSPORT INFORMATION

U.S. DEPARTMENT OF TRANSPORTATION (DOT)

Hazard Class:	Not Regulated	United Nations (UN) Number:	Not Applicable
Labels:	Not Applicable	North America (NA) Number:	Not Applicable
Placards:	Not Applicable	Bill of Lading:	Product Name

INTERNATIONAL

Canadian TDG Hazard Class & PIN: Not regulated
Not classified as dangerous goods under ADR (road), RID (train) or IMDG (ship).

15. REGULATORY INFORMATION

UNITED STATES REGULATIONS

SARA Title III: This product does not contain any substances reportable under Sections 302, 304, 313 (40 CFR 372). Sections 311 and 312 apply.

OSHA: Comply with Hazard Communication Standards 29 CFR 1910.1200 and 29 CFR 1926.59 and Respiratory Protection Standards 29 CFR 1910.134 and 29 CFR 1926.103.

TSCA: All substances contained in this product are listed in the TSCA Chemical Inventory

California: "Silica, crystalline (airborne particles of respirable size)" is listed in Proposition 65, The Safe Drinking Water and Toxic Enforcement Act of 1986 as a chemical known to the State of California to cause cancer.

Other States: Crystalline silica products are not known to be regulated by states other than California; however, state and local OSHA and EPA regulations may apply to these products. Contact your local agency if in doubt.

INTERNATIONAL REGULATIONS

Canadian WHMIS: Class D-2A Materials Causing Other Toxic Effects

Canadian EPA: All substances in this product are listed, as required, on the Domestic Substance List (DSL).

16. OTHER INFORMATION

SARA TITLE III HAZARD CATEGORIES

Acute Health:	No	Pressure Hazard:	No
Chronic Health:	Yes	Reactivity Hazard:	No
Fire Hazard:	No		

MSDS No: 141

Date Prepared: 05/01/1987

Current Date: 4/12/2006

Last Revised: (04/10/2006)

DEFINITIONS:

ACGIH:	American Conference of Governmental Industrial Hygienists
ADR:	Carriage of Dangerous Goods by Road (International Regulation)
CAA:	Clean Air Act
CAS:	Chemical Abstracts Service Registry Number
CERCLA:	Comprehensive Environmental Response, Compensation and Liability Act
EPA:	Environmental Protection Agency
EU:	European Union
f/cc:	Fibers per cubic centimeter
HEPA:	High Efficiency Particulate Air
HMIS:	Hazardous Materials Identification System
IARC:	International Agency for Research on Cancer
IATA:	International Air Transport Association
IMDG:	International Maritime Dangerous Goods Code
mg/m³:	Milligrams per cubic meter of air
mppcf:	Million particles per cubic meter
MSHA:	Mine Safety and Health Administration
NFPA:	National Fire Protection Association
NIOSH:	National Institute for Occupational Safety and Health
OSHA:	Occupational Safety and Health Administration
PEL:	Permissible Exposure Limit
PNOC:	Particulates Not Otherwise Classified
PNOR:	Particulates Not Otherwise Regulated
RCRA:	Resource Conservation and Recovery Act
RID:	Carriage of Dangerous Goods by Rail (International Regulation)
SARA:	Superfund Amendments and Reauthorization Act
Title III:	Emergency Planning and Community Right to Know Act
...Section 302:	Extremely Hazardous Substances
...Section 304:	Emergency Release
...Section 311:	MSDS/List of Chemicals
...Section 312:	Emergency and Hazardous Inventory
...Section 313:	Toxic Chemicals Release Reporting
STEL:	Short-Term Exposure Limit
TCLP:	Toxicity Characteristics Leaching Procedures (EPA)
TLV:	Threshold Limit Values (ACGIH)
TSCA:	Toxic Substance Control Act
WHMIS:	Workplace Hazardous Materials Information System (Canada)
29 CFR 1910.134 & 1926.103:	OSHA Respiratory Protection Standards
29 CFR 1910.1200 & 1926.59:	OSHA Hazard Communication Standards

Revision Summary: **Section 1:** Product Cer-Flex® added.

MSDS Prepared By: THERMAL CERAMICS ENVIRONMENTAL, HEALTH & SAFETY DEPARTMENT

DISCLAIMER

The information presented herein is presented in good faith and believed to be accurate as of the effective date of this Material Safety Data Sheet. Employers may use this MSDS to supplement other information gathered by them in their efforts to assure the health and safety of their employees and the proper use of the product. This summary of the relevant data reflects professional judgment; employers should note that information perceived to be less relevant has not been included in this MSDS. Therefore, given the summary nature of this document, Thermal Ceramics does not extend any warranty (expressed or implied), assume any responsibility, or make any representation regarding the completeness of this information or its suitability for the purposes envisioned by the user.



MATERIAL SAFETY DATA SHEET

A.P. Green, Harbison-Walker and NARCO

Page 1/6

Printing date 05/12/2004

Reviewed on 06/12/2007

1 Identification of substance

· **Product details**

· **Trade name:** GREENSET-94-P

· **Manufacturer/Supplier:**

ANH Refractories Company
400 Fairway Drive
Moon Township, PA 15108

General Phone: (412)375-6600

· **Information department:** MSDS Technical Information: (412)375-6837

· **Emergency information:** CHEMTREC 24 HOUR EMERGENCY PHONE NUMBER: 1-800-424-9300.

2 Composition/Data on components

· **Chemical characterization**

· **Description:** Mixture of the substances listed below with nonhazardous additions.

· **Components:**

1344-28-1	non-fibrous alumina	60-100%
7664-38-2	phosphoric acid	5-10%
13530-50-2	aluminum phosphate binder (as P2O5)	1-2.5%
1302-78-9	bentonite	1-2.5%
14808-60-7	crystalline silica (quartz)	0.1-0.5%

· **Additional information:** For the wording of the listed risk phrases refer to section 16.

3 Hazards identification

· **Hazard description:**

Toxic

· **Medical conditions aggravated by exposure to the product:** Asthma, chronic lung disease, and skin irritation.

· **Carcinogenicity Information:**

Crystalline silica is listed by IARC as a Group 1 Carcinogen "sufficient evidence of carcinogenicity in humans", and is listed by NTP as K, "Known To Be A Human Carcinogen".

· **Information pertaining to particular dangers for man and environment:**

The product has to be labelled due to the calculation procedure of the "General Classification guideline for preparations of the EU" in the latest valid version.

May cause cancer by inhalation.

Irritating to eyes, respiratory system and skin.

· **NFPA ratings (scale 0-4)**

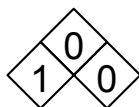

Health = 1

Fire = 0

Reactivity = 0

(Contd. on page 2)

USA



MATERIAL SAFETY DATA SHEET

A.P. Green, Harbison-Walker and NARCO

Page 2/6

Printing date 05/12/2004

Reviewed on 06/12/2007

Trade name: **GREENSET-94-P**

(Contd. from page 1)

· **HMIS Classification**

HEALTH	1	Health: 1
FIRE	0	Flammability: 0
REACTIVITY	0	Reactivity: 0

4 First aid measures

- **After inhalation:** Move to fresh air; consult doctor if needed.
- **After skin contact:** Immediately wash with water and soap and rinse thoroughly.
- **After eye contact:** Flush eyes with water for 15 minutes. If irritation persists, consult a doctor.
- **After swallowing:**
This product is intended for industrial applications; in the unlikely event that this product is swallowed, consult a physician if any adverse medical conditions occur.

5 Fire fighting measures

- **Suitable extinguishing agents:** Use fire fighting measures that suit the environment.
- **Protective equipment:** No special measures required.

6 Accidental release measures

- **Person-related safety precautions:** Not required.
- **Measures for environmental protection:** No special measures required.
- **Measures for cleaning/collecting:**
Dispose contaminated material as waste according to item 13.
Ensure adequate ventilation.

7 Handling and storage

- **Handling:**
- **Information for safe handling:**
Ensure good ventilation/exhaust at the workplace.
Prevent formation of dust.
- **Information about protection against explosions and fires:** No special measures required.
- **Storage:**
- **Requirements to be met by storerooms and containers:** No special requirements.
- **Information about storage in one common storage facility:** Not required.
- **Further information about storage conditions:** Store product inside, out of extreme weather conditions.

USA

(Contd. on page 3)



Trade name: GREENSET-94-P

(Contd. from page 2)

8 Exposure controls and personal protection

· **Components with limit values that require monitoring at the workplace:**

1344-28-1 non-fibrous alumina

PEL	15*;5** mg/m ³ *Total dust **Respirable fraction
TLV	10 mg/m ³ (e)

7664-38-2 phosphoric acid

PEL	1 mg/m ³
REL	Short-term value: 3 mg/m ³ Long-term value: 1 mg/m ³
TLV	Short-term value: 3 mg/m ³ Long-term value: 1 mg/m ³

14808-60-7 crystalline silica (quartz)

REL	0.05* mg/m ³ *Respirable dust
TLV	0.05 R mg/m ³

· **Personal protective equipment:**

· **General protective and hygienic measures:**

- Keep away from foodstuffs, beverages and feed.
- Wash hands before breaks and at the end of work.
- Store protective clothing separately.
- Avoid contact with the eyes and skin.

· **Breathing equipment:**



NIOSH approved respirators should be used if dust is present. A respiratory protection program should be implemented if exposures exceed OSHA PELs.

· **Protection of hands:**



Protective gloves recommended

The glove material has to be impermeable and resistant to the product/ the substance/ the preparation.

Due to missing tests no recommendation to the glove material can be given for the product/ the preparation/ the chemical mixture.

Selection of the glove material on consideration of the penetration times, rates of diffusion and the degradation

· **Material of gloves**

The selection of the suitable gloves does not only depend on the material, but also on further marks of quality and varies from manufacturer to manufacturer. As the product is a preparation of several substances, the resistance of the glove material can not be calculated in advance and has therefore to be checked prior to the application.

· **Penetration time of glove material**

The exact break through time has to be found out by the manufacturer of the protective gloves and has to be observed.

(Contd. on page 4)



MATERIAL SAFETY DATA SHEET

A.P. Green, Harbison-Walker and NARCO

Page 4/6

Printing date 05/12/2004

Reviewed on 06/12/2007

Trade name: GREENSET-94-P

(Contd. from page 3)

· **Eye protection:** Safety glasses with side shields recommended

9 Physical and chemical properties

· General Information

Form:	Solid
Color:	According to product specification
Odor:	No specific odor.

· Change in condition

Melting point/Melting range: Undetermined.
Boiling point/Boiling range: Undetermined.

· **Flash point:** Not applicable.

· **Auto igniting:** Product is not selfigniting.

· **Danger of explosion:** Product does not present an explosion hazard.

· **Density:** Not determined.

· **Solubility in / Miscibility with Water:** Insoluble.

10 Stability and reactivity

· **Thermal decomposition / conditions to be avoided:** No decomposition if used according to specifications.

· **Dangerous reactions** No dangerous reactions known.

· **Dangerous products of decomposition:**

Refractories containing crystalline silica may, after service, contain more or less crystalline silica. Care must be taken to avoid and/or control dust from demolition. If in doubt of the proper protection, seek advice from a safety professional.

11 Toxicological information

· **Acute toxicity:**

· **Primary acute effects:**

· **Skin contact:** Irritant to skin and mucous membranes.

· **Eye contact:** Irritating effect.

· **Sensitization:** No sensitizing effects known.

· **Additional toxicological information:**

The product shows the following dangers according to internally approved calculation methods for preparations:
Irritant

Carcinogenic if inhaled.

USA

(Contd. on page 5)



MATERIAL SAFETY DATA SHEET

A.P. Green, Harbison-Walker and NARCO

Page 5/6

Printing date 05/12/2004

Reviewed on 06/12/2007

Trade name: GREENSET-94-P

(Contd. from page 4)

12 Ecological information

- **General notes:** At present there are no ecotoxicological assessments.

13 Disposal considerations

- **Recommendation for Disposal of Product:**
As sold, this product is not RCRA hazardous. Final used condition must be evaluated prior to disposal. Dispose of waste product in accordance with Federal, State and Local regulations.
Dust created during demolition of used product may contain crystalline silica.
- **Recommendation for Disposal of Uncleaned Packaging:** Reuse, recycle or treat as industrial waste.

14 Transport information

- **Transport/Additional information:** Not dangerous according to available information.

15 Regulations

· SARA 313 TOXIC CHEMICALS

No material listed in the components in Section 2 of this MSDS is on the SARA 313 list.

· SARA 302 EXTREMELY HAZARDOUS SUBSTANCES

No material listed in the components in Section 2 of this MSDS is on the SARA 302 list.

· TSCA (Toxic Substances Control Act)

This substance or all the ingredients of this product are on the Chemical Substances Inventory of the Toxic Substances Control Act (TSCA Inventory). The presence on this list does not require any legal reporting.

· WHMIS Classification

Class D - Division 2 - Sub Division A

Untested mixture containing a very toxic material

Class D - Division 2 - Sub Division B

Untested mixture containing a toxic material

This product has been classified in accordance with the hazard criteria of the Controlled Products Regulations (CPR) and the MSDS contains all the information required by the CPR.

· Cancerogenity categories

· EPA (Environmental Protection Agency)

None of the ingredients is listed.

· IARC (International Agency for Research on Cancer)

14808-60-7	crystalline silica (quartz)	1
------------	-----------------------------	---

· NTP (National Toxicology Program)

14808-60-7	crystalline silica (quartz)	R
------------	-----------------------------	---

· TLV (Threshold Limit Value established by ACGIH)

1344-28-1	non-fibrous alumina	A4
-----------	---------------------	----

14808-60-7	crystalline silica (quartz)	A2
------------	-----------------------------	----

(Contd. on page 6)

USA



MATERIAL SAFETY DATA SHEET

A.P. Green, Harbison-Walker and NARCO

Page 6/6

Printing date 05/12/2004

Reviewed on 06/12/2007

Trade name: GREENSET-94-P

(Contd. from page 5)

· **MAK (German Maximum Workplace Concentration)**

1344-28-1	non-fibrous alumina	2
14808-60-7	crystalline silica (quartz)	1

· **NIOSH-Ca (National Institute for Occupational Safety and Health)**

14808-60-7	crystalline silica (quartz)
------------	-----------------------------

· **OSHA-Ca (Occupational Safety & Health Administration)**

None of the ingredients is listed.

· **Classification according to EU-guidelines**

· **Hazard symbols:**

Toxic

· **Hazard-determining components of labeling:**

crystalline silica (quartz)

· **Risk phrases:**

May cause cancer by inhalation.

Irritating to eyes, respiratory system and skin.

· **Safety phrases:**

When using do not eat or drink.

Do not breathe dust.

Avoid contact with eyes.

In case of contact with eyes, rinse immediately with plenty of water and seek medical advice.

After contact with skin, wash immediately with plenty of soap and water

Wear suitable protective clothing and gloves.

In case of accident or if you feel unwell, seek medical advice immediately.

· **National regulations:**

· **The following ingredients are known in the state of California to be a cancer risk (Proposition 65):**

14808-60-7	crystalline silica (quartz)
------------	-----------------------------

16 Other information

This information is based on our present knowledge. However, this shall not constitute a guarantee for any specific product features and shall not establish a legally valid contractual relationship.

· **Contact:** Patricia A. Kott 412-375-6712

· **Creation date:** 08/14/2000



100 Mansell Court East, Suite 300; Roswell, GA 30076
 Telephone (770) 594-0660 Fax: (770) 645-3384
 Customer Service: (800) 251-6327

MATERIAL SAFETY DATA SHEET

Section 1 - Material Identity

Product Trade Name(s): 6-Tile
 Common Name(s): Kaolin Clay, China Clay
 Chemical Name: Kaolin
 CAS Number: 1332-58-7 (In TSCA Inventory)
 Physical Form: White Powder

HMIS Ratings

Health Hazard	1
Flammability Hazard	0
Reactivity Hazard	0
Max. Personal Protection	E

Manufacturer's Name & Address: IMERYS Pigments & Additives Group, 100 Mansell Court East, Suite 300; Roswell, GA 30076
 Emergency Telephone: (800) 424-9300 CHEMTREC

Section 2 - Ingredients and Hazards

Ingredient	Wt. % (Approx.)	CAS No.	OSHA PEL*	ACGIH TLV*
Kaolin - Al ₂ Si ₂ O ₇ (OH) ₂	> 98%	1332-58-7	5 mg/m ³ Resp. 15 mg/m ³ Total	2 mg/m ³ Resp. --
Crystalline Silica, Quartz	> 0.1% - ~1%	14808-60-7	0.1 mg/m ³ Resp.	0.05 mg/m ³ Resp.
Water	< 2%			

* Unless otherwise noted, all PEL and TLV values are reported as 8 hour time weighted averages (TWA).

Section 3 - Hazards Identification and Cautions

Appearance: White Powder
 Primary Routes of Entry: Skin contact, skin absorption, eye contact, ingestion; Hazard Classification - None.
 (Historical basis for classification.)

Target Organs: Eye, skin and lungs
 Medical Conditions Aggravated by Exposure: Skin contact may aggravate existing dermatitis. Breathing excessive quantities of kaolin dust may aggravate pre-existing respiratory conditions.

Potential Health Effects:

Eye Contact: This product may produce irritation upon contact with the eye. See also Section 4 below.
Skin Contact: Prolonged or repeated exposure may cause skin irritation. Kaolin is not expected to be absorbed through the skin in harmful amounts or to produce an allergic skin reaction. See also Section 4 below.
Ingestion: No adverse effect is expected. If ingested, seek medical advice. See also Section 4 below.
Inhalation: Inhalation of excessive quantities of kaolin dust may irritate the respiratory tract. Prolonged exposure to respirable kaolin dust without use of appropriate respiratory equipment could adversely affect respiratory function including fibrogenic response. See Am. Rev. Respir. Dis. 1983; 127:215-220; 231-253; 141-142; Doc. Thres. Limit Values and Bio. Exp. Ind., Sixth Edition, 1991: OSHA PEL-29 C.F.R. 1910.1000.
Subchronic, Chronic: None expected. No applicable information was found concerning any potential health effects resulting from subchronic or chronic exposure to kaolin.

This product typically contains crystalline silica (quartz sand) above 0.1% as a naturally occurring impurity. The International Agency for Research on Cancer has concluded that "crystalline silica inhaled in the form of quartz or

crystalite from occupational sources is carcinogenic to humans (Group 1).⁶ It also noted that carcinogenicity was not detected in all industrial circumstance studies, and may be dependent on external factors affecting its biological activity or distribution of its polymorphs. (See IARC Monographs on the Evaluation of Carcinogenic Risks to Humans, Volume 68 (1997).) Exposure to respirable silica has also been associated with silicosis, scleroderma, and nephrotoxicity. (See Occupational Lung Disorders, Third Edition, Chapter 12 (1994) and American Journal of Respiratory and Critical Care Medicine, Volume 155, pp 761-765 (1997).)

Section 4 - First Aid Measures

Eye Contact: Follow good industrial hygiene practices. In case of contact, immediately flush eyes with plenty of water. Seek medical aid if necessary.

Skin Contact: Follow good industrial hygiene practices. Wash affected skin areas thoroughly with soap and water. Seek medical aid if necessary.

Inhalation: Follow good industrial hygiene practices. If excessive exposure by inhalation is suspected, remove to fresh air. If necessary, a MSHA/NIOSH or OSHA/NIOSH approved respirator is recommended. Seek medical aid if necessary.

Ingestion: Follow good industrial hygiene practices. If ingested, do not induce vomiting. If conscious, drink two glasses of water. Seek medical aid if necessary.

Section 5 - Fire Fighting Measures

Explosion Data: Not Explosive
LEL: Not Applicable
UEL: Not Applicable
Extinguishing Media: Product will not burn.
NEPA 704M Hazard Classification: Health: 1 Flammable: 0 Reactivity: 0

Flammability: Not Flammable or Combustible
Flash Point: Not Applicable
Auto-Ignition: Not Applicable

Use appropriate extinguishing media for packaging material if applicable.

Section 6 - Accidental Release Measures

Vacuum, pump or scoop spilled material into containers for reclaiming or disposal. Use proper respiratory and personal protective equipment. MSHA/NIOSH or OSHA/NIOSH approved respirator recommended. Spilled materials may cause slippery conditions when wet. Care should be exercised when walking on spills on floors or concrete pads. No neutralizing chemicals required. Material is inert and nonreactive. Kaolin is not a CERCLA listed hazardous substance.

Section 7 - Handling and Storage

Storage in a cool, dry location is recommended.
 Spilled materials may cause slippery conditions when wet. Care should be exercised when walking on spills on floors or concrete pads.
 Minimize dust generation & accumulation.
 If excessive dust is generated, provide adequate ventilation and use proper respiratory and personal protective equipment.
 MSHA/NIOSH or OSHA/NIOSH approved respirator recommended

Section 8 - Exposure Control/Personal Protection

<u>Hazardous Ingredient</u>	<u>Weight % (Approx.)</u>	<u>CAS No.</u>	<u>MSHA PEL</u>	<u>OSHA PEL</u>	<u>ACGIH TLV</u>
		1332-58-7	10mg/cu.m. Total	15mg/cu.m. Total 5 mg/cu.m. Resp.	2 mg/cu.m. Respirable
Crystalline Silica, Quartz	> 0.1% - ~1%	14808-60-7	0.1 mg/m ³ Resp	0.1 mg/m ³ Resp.	0.05 mg/m ³ Resp.

Unless otherwise noted, all PEL and TLV values are reported as 8 hour time weighted averages (TWA).

Respiratory Protection: If respirator is required, use of a MSHA/NIOSH or OSHA/NIOSH approved respirator is recommended.

Ventilation: Use exhaust ventilation, if required, to maintain dust concentration below recommended exposure limits.

Protective Equipment: Wear side shield safety glasses. Rubber gloves are recommended for prolonged exposure.

Section 9 - Physical and Chemical Properties

Physical State:	Solid	Boiling Point:	Not Applicable
Appearance & Odor:	Odorless, white powder	Freezing Point:	Not Applicable
pH (Aqueous Suspension):	4.0 - 6.0	Vapor Pressure:	Not Applicable
Specific Gravity:	~2.6	Vapor Density:	Not Applicable
% Solubility in Water:	Insoluble	VOC:	None

Melting Point: Not Determined, > 1500°C Evaporation Rate: Not Applicable

Section 10 - Stability and Reactivity

Chemically Stable? Yes X No ___ Inert and nonreactive.
Compatible with Other Substances? Yes X No ___ Inert and nonreactive.
Hazardous Decomposition/By-Products: No hazardous decomposition or by-products expected. Inert and nonreactive.
Conditions Contributing to Hazardous Polymerization: None, inert and nonreactive.

Section 11 - Disposal Considerations

EPA Waste Number: Under RCRA (40 CFR 261) kaolin is a non-hazardous waste. Dispose of waste material in accordance with all local, state and federal requirements.

Section 12 - Toxicological Information

kaolin - CAS No. 1332-58-7
Primary Route of Exposure: X Skin; X Eye Contact; X Inhalation; ___ Ingestion

Acute Health Hazards:
Eye contact may cause mechanical irritation if exposed to excessive amounts of kaolin.
Skin contact may aggravate existing dermatitis.
Inhalation from prolonged and continuous exposure to excessive quantities of dust may aggravate existing asthmatic or respiratory conditions.
No adverse effect expected when ingested.

Chronic Health Hazards:
Prolonged inhalation of excessive levels of kaolin dust may cause a simple pneumoconiotic condition, not normally associated with a decrement in lung function. In cases of long term exposure to extremely high levels of dust, complicated pneumoconiosis with lung function impairment may occur.

Carcinogenicity*: NTP? No IARC? No OSHA? No
Mutagenicity: None known Teratogenicity: None known Reproductive Effects: None known

* See Section 3 for discussion of crystalline silica.

Section 13 - Transport Information

EPA Waste Number: Not Regulated
DOT Classification: Not Regulated DOT/IMO Classification: Not Regulated
Internal UN: Not Regulated

Section 14 - Regulatory Information

FDA: Kaolin is as generally recognized as safe (GRAS) under the FDA in accordance with 21 CFR 186.1256. Additionally, kaolin is established as a component of the uncoated or coated food-contact surface of paper and paperboard in accordance with 21 CFR 176.170 (aqueous and fatty foods) and 21 CFR 176.180 (dry foods).

SARA Title III Section 302 Extremely Hazardous Substances: This product does not contain extremely hazardous substances subject to the reporting requirements of Section 302 of Title III of the Superfund Amendments and Reauthorization Act of 1986 and 40 CFR Part 355.

SARA Title III Section 311 and 312 Health and Physical Hazard Categories per 40 CFR 370.2:

Immediate	Delayed	Fire	Pressure	Reactivity
Yes	Yes	No	No	No

SARA Section 313 Notification: This product does not contain toxic chemicals subject to the reporting requirements of Section 313 of Title III of the Superfund Amendments and Reauthorization Act of 1986 and 40 CFR Part 372.

TSCA: Product is listed in Initial Inventory, Vol. 1, Appendix A, CAS No. 1332-58-7.

The International Agency for Research on Cancer has concluded that "crystalline silica inhaled in the form of quartz or cristobalite from occupational sources is carcinogenic to humans (Group I)." It also noted that carcinogenicity was not detected in all industrial circumstance studies, and may be dependent on external factors affecting its biological activity or distribution of its polymorphs. (See IARC Monographs on the Evaluation of Carcinogenic Risks to Humans, Volume 68 (1997).) Exposure to respirable silica has also been associated with silicosis, scleroderma, and nephrotoxicity. (See Occupational Lung Disorders, Third Edition, Chapter 12 (1994) and American Journal of Respiratory and Critical Care Medicine, Volume 155, pp 761-765 (1997).)

WARNING: This product may also contain extremely small amounts of one or more naturally-occurring materials known to the State of California to cause cancer, birth defects, or other reproductive harm.

While this information and recommendations set forth herein are believed to be accurate as of the date hereof, IMERYS PIGMENTS & ADDITIVES GROUP MAKES NO WARRANTY, EXPRESS OR IMPLIED, WITH RESPECT HERETO

AND DISCLAIMS ALL LIABILITY FROM RELIANCE THEREON.

IMERYS is a business name of IMERYS Pigments, Inc., IMERYS Kaolin, Inc. and IMERYS Marble, Inc.
Registered in the USA. Registered Office: 100 Mansell Court East, Suite 300, Roswell, GA 30076.

Date Prepared: 07/27/82

Revised: 06/2000

MSDS Number: **A2796** * * * * * Effective Date: **11/09/06** * * * * * Supersedes: **02/12/04**

This material is
used in the Cone 10
Kiln Wash

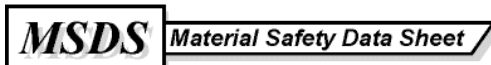

From: Mallinckrodt Baker, Inc.
222 Red School Lane
Phillipsburg, NJ 08865



24 Hour Emergency Telephone: 908-859-2151
CHEMTREC: 1-800-424-9300

National Response in Canada
CANUTEC: 613-996-6666

Outside U.S. And Canada
Chemtrec: 703-527-3887

NOTE: CHEMTREC, CANUTEC and National Response Center emergency numbers to be used only in the event of chemical emergencies involving a spill, leak, fire, exposure or accident involving chemicals.

All non-emergency questions should be directed to Customer Service (1-800-582-2537) for assistance.

Aluminum Hydroxide

1. Product Identification

Synonyms: Aluminum hydrate; Aluminum trihydrate; Hydrated alumina

CAS No.: 21645-51-2

Molecular Weight: 78.00

Chemical Formula: Al(OH)₃

Product Codes: 0518

2. Composition/Information on Ingredients

Ingredient	CAS No	Percent	Hazardous
Aluminum Hydroxide	21645-51-2	98 - 100%	Yes

3. Hazards Identification

Emergency Overview

WARNING! CAUSES IRRITATION TO EYES AND RESPIRATORY TRACT.

SAF-T-DATA^(tm) Ratings (Provided here for your convenience)

Health Rating: 1 - Slight

Flammability Rating: 0 - None

Reactivity Rating: 1 - Slight

Contact Rating: 2 - Moderate

Lab Protective Equip: GOGGLES; LAB COAT; PROPER GLOVES

Storage Color Code: Green (General Storage)

Potential Health Effects

Inhalation:

Causes irritation to the respiratory tract. Symptoms may include coughing, shortness of breath.

Ingestion:

Not expected to be a health hazard via ingestion.

Skin Contact:

Not expected to be a health hazard from skin exposure.

Eye Contact:

Causes irritation, redness, and pain.

Chronic Exposure:

Repeated exposure may cause symptoms similar to those listed for acute effects. Prolonged contact with skin may result in minor mechanical irritation.

Aggravation of Pre-existing Conditions:

No information found.

4. First Aid Measures

Inhalation:

Remove to fresh air. If not breathing, give artificial respiration. If breathing is difficult, give oxygen. Get medical attention.

Ingestion:

Not expected to require first aid measures. If large amounts were swallowed, give water to drink and get medical advice.

Skin Contact:

Wash exposed area with soap and water. Get medical advice if irritation develops.

Eye Contact:

Immediately flush eyes with plenty of water for at least 15 minutes, lifting lower and upper eyelids occasionally. Get medical attention immediately.

5. Fire Fighting Measures

Fire:

Not considered to be a fire hazard.

Explosion:

Not considered to be an explosion hazard.

Fire Extinguishing Media:

Use any means suitable for extinguishing surrounding fire.

Special Information:

In the event of a fire, wear full protective clothing and NIOSH-approved self-contained breathing apparatus with full facepiece operated in the pressure demand or other positive pressure mode.

6. Accidental Release Measures

Ventilate area of leak or spill. Wear appropriate personal protective equipment as specified in Section 8. Spills: Sweep up and containerize for reclamation or disposal. Vacuuming or wet sweeping may be used to avoid dust dispersal.

7. Handling and Storage

Keep in a tightly closed container, stored in a cool, dry, ventilated area. Protect against physical damage. Isolate from incompatible substances. Containers of this material may be hazardous when empty since they retain product residues (dust, solids); observe all warnings and precautions listed for the product.

8. Exposure Controls/Personal Protection

Airborne Exposure Limits:

None established.

Ventilation System:

In general, dilution ventilation is a satisfactory health hazard control for this substance. However, if conditions of use create discomfort to the worker, a local exhaust system should be considered.

Personal Respirators (NIOSH Approved):

For conditions of use where exposure to dust or mist is apparent and engineering controls are not feasible, a particulate respirator (NIOSH type N95 or better filters) may be worn. If oil particles (e.g. lubricants, cutting fluids, glycerine, etc.) are present, use a NIOSH type R or P filter. For emergencies or instances where the exposure levels are not known, use a full-face positive-pressure, air-supplied respirator. WARNING: Air-purifying respirators do not protect workers in oxygen-deficient atmospheres.

Skin Protection:

Wear protective gloves and clean body-covering clothing.

Eye Protection:

Use chemical safety goggles and/or full face shield where dusting or splashing of solutions is possible. Maintain eye wash fountain and quick-drench facilities in work area.

9. Physical and Chemical Properties

Appearance:

White Powder.

Odor:

Odorless.

Solubility:

Practically insoluble in water.

Specific Gravity:

2.42

pH:

> 7 (Basic).

% Volatiles by volume @ 21C (70F):

0

Boiling Point:

No information found.

Melting Point:

300C (572F)

Vapor Density (Air=1):

Not applicable.

Vapor Pressure (mm Hg):

Not applicable.

Evaporation Rate (BuAc=1):

No information found.

10. Stability and Reactivity

Stability:

Stable under ordinary conditions of use and storage. Aluminum hydroxide forms a gel on prolonged contact with water; absorbs acids and carbon dioxide.

Hazardous Decomposition Products:

May produce oxides of aluminum.

Hazardous Polymerization:

Will not occur.

Incompatibilities:

Strong acids, strong oxidizers. Aluminum hydroxide can react dangerously with bismuth.

Conditions to Avoid:

Moisture and incompatibles.

11. Toxicological Information

No LD50/LC50 information found relating to normal routes of occupational exposure.

Ingredient	--NTP Carcinogen--		IARC Category
	Known	Anticipated	
Aluminum Hydroxide (21645-51-2)	No	No	None

12. Ecological Information

Environmental Fate:

No information found.

Environmental Toxicity:

No information found.

13. Disposal Considerations

Whatever cannot be saved for recovery or recycling should be managed in an appropriate and approved waste disposal facility. Processing, use or contamination of this product may change the waste management options. State and local disposal regulations may differ from federal disposal regulations. Dispose of container and unused contents in accordance with federal, state and local requirements.

14. Transport Information

Not regulated.

15. Regulatory Information

-----\Chemical Inventory Status - Part 1\-----				
Ingredient	TSCA	EC	Japan	Australia
Aluminum Hydroxide (21645-51-2)	Yes	Yes	Yes	Yes

-----\Chemical Inventory Status - Part 2\-----				
Ingredient	Korea	--Canada--		
		DSL	NDSL	Phil.
Aluminum Hydroxide (21645-51-2)	Yes	Yes	No	Yes

-----\Federal, State & International Regulations - Part 1\-----				
Ingredient	-SARA 302-		-SARA 313-	
	RQ	TPQ	List	Chemical Catg.
Aluminum Hydroxide (21645-51-2)	No	No	No	No

-----\Federal, State & International Regulations - Part 2\-----				
---	--	--	--	--

Ingredient	CERCLA	-RCRA- 261.33	-TSCA- 8(d)
Aluminum Hydroxide (21645-51-2)	No	No	No

Chemical Weapons Convention: No TSCA 12(b): No CDTA: No
 SARA 311/312: Acute: Yes Chronic: Yes Fire: No Pressure: No
 Reactivity: No (Pure / Solid)

Australian Hazchem Code: None allocated.

Poison Schedule: None allocated.

WHMIS:

This MSDS has been prepared according to the hazard criteria of the Controlled Products Regulations (CPR) and the MSDS contains all of the information required by the CPR.

16. Other Information

NFPA Ratings: Health: 1 Flammability: 0 Reactivity: 0

Label Hazard Warning:

WARNING! CAUSES IRRITATION TO EYES AND RESPIRATORY TRACT.

Label Precautions:

Avoid contact with eyes, skin and clothing.

Wash thoroughly after handling.

Avoid breathing dust.

Keep container closed.

Use only with adequate ventilation.

Label First Aid:

In case of eye contact, immediately flush eyes with plenty of water for at least 15 minutes. Remove material from skin and clothing. If inhaled, remove to fresh air. If not breathing, give artificial respiration. If breathing is difficult, give oxygen. In all cases, get medical attention.

Product Use:

Laboratory Reagent.

Revision Information:

MSDS Section(s) changed since last revision of document include: 3.

Disclaimer:

Mallinckrodt Baker, Inc. provides the information contained herein in good faith but makes no representation as to its comprehensiveness or accuracy.

This document is intended only as a guide to the appropriate precautionary handling of the material by a properly trained person using this product.

Individuals receiving the information must exercise their independent judgment in determining its appropriateness for a particular purpose.

MALLINCKRODT BAKER, INC. MAKES NO REPRESENTATIONS OR WARRANTIES, EITHER EXPRESS OR IMPLIED, INCLUDING WITHOUT LIMITATION ANY WARRANTIES OF MERCHANTABILITY, FITNESS FOR A PARTICULAR PURPOSE WITH RESPECT TO THE INFORMATION SET FORTH HEREIN OR THE PRODUCT TO WHICH THE INFORMATION REFERS. ACCORDINGLY, MALLINCKRODT BAKER, INC. WILL NOT BE RESPONSIBLE FOR DAMAGES RESULTING FROM USE OF OR RELIANCE UPON THIS INFORMATION.

Prepared by: Environmental Health & Safety

Phone Number: (314) 654-1600 (U.S.A.)

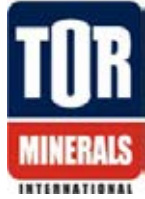

HMIS RATING
 HEALTH ----- 1
 FLAMMABILITY ----- 0
 REACTIVITY ----- 0
 PERSONAL PROTECTION - E

Material Safety Data Sheet

May be used to comply with
 OSHA's Hazard Communication Standard,
 29 CFR 1910.1200. Standard must be
 consulted for specific requirements.

U.S. Department of Labor

Occupational Safety and Health Administration
 (Non-Mandatory Form)
 Form Approved
 OMB No. 1218-0072



IDENTITY (As Used on Label and List)

HALTEX® Alumina Trihydrate (all grades)

Note: Blank spaces are not permitted. If any item is not applicable, or no information is available, the space must be marked to indicate that.

Section I

Manufacturer's Name TOR Minerals International	Emergency Telephone Number 361/883-5591
Address (Number, Street, City, State, and ZIP Code) 722 Burleson Street (Plant) Corpus Christi, TX 78402	Telephone Number for Information 361/883-5591
	Date Prepared January 2006
	Signature of Preparer (optional)

Section II - Hazardous Ingredients/Identity Information

Hazardous Components (Specific Chemical Identity; Common Name(s))	OSHA PEL	ACGIH TLV	Other Limits Recommended	% (optional)
Aluminium Trihydrate (Al(OH)₃) (CAS No. 21645-51-2)	10 mg/m³ (dust)	10 mg/m³ (dust)		100.0%
<i>(These are typical quantities and may change slightly with different lots.)</i>				

Section III - Physical/Chemical Characteristics

Boiling Point	2980 ± 60	Specific Gravity (H ₂ O = 1)	2.38 - 2.42
Vapor Pressure (mm Hg.)	N/A	Melting Point	2015 ± 15
Vapor Density (AIR = 1)	N/A	Evaporation Rate (Butyl Acetate = 1)	N/A
Solubility in Water	Insoluble		
Appearance and Odor	Fine white powder with no odor.		

Section IV - Fire and Explosion Hazard Data

Flash Point (Method Used)	Non-flammable	Flammable Limits	N/A	LEL	N/A	UEL	N/A
Extinguishing Media	As appropriate for surrounding combustibles. Does not burn or support combustion.						
Special Fire Fighting Procedures	Fire fighters should wear self-contained breathing apparatus.						
Unusual Fire and Explosion Hazards	No fire or explosion hazard.						

Section V - Reactivity Data

Stability	Unstable		Conditions to Avoid	None in normal or expected use
	Stable	X		
Incompatibility (Material to Avoid) None Known				
Hazardous Decomposition or Byproducts None in normal or expected use				
Hazardous Polymerization	May Occur		Conditions to Avoid	None in normal or expected use
	Will Not Occur	X		

Section VI - Health Hazard Data

Route(s) of Entry:	Primary	Inhalation?	Yes	Skin? Eye ?	No Yes	Ingestion?	Yes
Health Hazards (Acute and Chronic) Hydrated Alumina is environmentally safe and is not regulated under RCRA. None of the components are on the EPA list of Extremely Hazardous Substances. However, high exposure to Alumina dust may produce irritation to the eyes and respiratory system.							
Carcinogenicity:	None known.	NTP?	N/A	IARC Monographs?	N/A	OSHA Regulated?	N/A

Signs and Symptoms of Irritation
Irritation of dust may cause mechanical irritation of the respiratory tract. Skin and eye contact may cause mechanical abrasion - irritation.

Medical Conditions
Generally Aggravated by Exposure Pre-existing upper respiratory and lung diseases such as, but not limited to, bronchitis, emphysema, and asthma.

Emergency and First Aid Procedures
Eye contact: Flush eye with generous amounts of water for 15 min., consult a physician.
Inhalation: Remove to fresh air. **Skin contact:** Wash from skin with soap and water. **Ingestion:** Consult a physician.

Section VII - Precautions for Safe Handling and Use

Steps to Be Taken in Case Material is Released or Spilled
Handle and keep in dry building area. Avoid handling methods which cause dusting. Avoid breathing dust. Use ventilation that will maintain exposure below recommended TLV. Wear goggles and use NIOSH/MSHA approved respirator. Wash thoroughly after handling.

Waste Disposal Method
Disposal must be made in accordance with Federal, State, and Local regulations, and pursuant to 40 CFR p. 261 of RCRA regulations currently in effect. Discarded hydrated alumina would not be classified as hazardous waste.

Precautions to Be Taken in Handling and Storing
Handle and keep in dry building area. Avoid handling methods which cause dusting. Avoid breathing dust. Use ventilation that will maintain exposure below recommended TLV. Wear goggles and use NIOSH/MSHA approved respirator. Wash thoroughly after handling.

Other Precautions No special requirements. Use good, acceptable industrial hygiene practices.

Section VIII - Control Measures

Respiratory Protection (Specify Type) Use NIOSH approved respirator in accordance with air contaminant standard.

Ventilation	Local Exhaust	Provide local system.	Special
	Mechanical (General)	Is recommended for potentially dusty conditions.	Other

Protective Gloves
No special requirement, ordinary work type.

Eye Protection Safety glasses or vented goggles.

Other Protective Clothing or Equipment
No special requirement, ordinary work clothes.

Work/Hygienic Practices
Good industrial hygiene practices. Wash thoroughly with soap and water before eating, drinking, or using tobacco products.

The information herein is believed to be correct and reliable. However no warranty is expressed or implied regarding the accuracy of these data, and none is made as to the marketability of the material or its fitness for any purpose. The consumer accepts the responsibility of and the conditions for liability of use of the products.

MATERIAL SAFETY DATA SHEET

MSDS No: 093

UNIMIN CORPORATION
258 Elm Street
New Canaan, CT 06840

Emergency Telephone Number
(203) 966-8880

Telephone Number for Information
(203) 966-8880

Date Prepared: July 2000

SECTION 1: IDENTIFICATION

PRODUCT NAME: Kaolin Slurry

SYNONYMS: Kaolin, China Clay, Hydrated Aluminum Silicate

SECTION 2: COMPONENTS

<u>CAS#</u>	<u>Component</u>	<u>Percentage</u>	<u>Exposure Limits</u>
1332-58-7	Kaolin	>65%	PEL – 5 mg/m ³ TWA (respirable fraction) TLV- 2 mg/m ³ TWA (respirable fraction) MSHA - 5 mg/m ³ TWA (respirable fraction)
14808-60-7	Crystalline Silica in the form of Quartz	<1%	PEL - See Below TLV- 0.05 mg/m ³ TWA (respirable fraction) MSHA - See Below
13463-67-7	Titanium Dioxide	<2%	PEL – 15 mg/m ³ TWA (total dust) TLV- 10 mg/m ³ TWA MSHA - 15 mg/m ³ TWA (total dust)
7332-18-5	Water	<34%	None Established

OSHA PEL and MSHA Exposure Limit for Crystalline Silica, Quartz: $\frac{10 \text{ mg/m}^3}{\% \text{ Silica} + 2}$
(Respirable)

National Institute for Occupational Safety and Health (NIOSH) has recommended that the permissible exposure limit be changed to 50 micrograms respirable free silica per cubic meter of air (0.05 mg/m³) as determined by a full shift sample up to 10 hour working day, 40 hours per week. The 1974 NIOSH Criteria for a recommended Standard for Occupational Exposure to Crystalline Silica should be consulted for more detailed information.

PEL means OSHA Permissible Exposure Limit.

TLV means American Conference of Governmental Industrial Hygienists (ACGIH) Threshold Limit Value.

MSHA means Mine Safety and Health Administration Exposure Limit.

TWA means 8 hour time weighted average.

Note: The Permissible Exposure Limits (PEL) reported above are the pre-1989 limits that were reinstated by OSHA June 30, 1993 following a decision by the 11th Circuit Court of Appeals. These PELs are now being enforced by Federal OSHA. Be aware that more restrictive exposure limits may be enforced by some states, agencies or other authorities.

SECTION 3: HAZARDS IDENTIFICATION

EMERGENCY OVERVIEW

This product is an aqueous slurry of a chemically inert, non-combustible mineral. A single exposure will not result in serious adverse effects. When this product is in a dryer form, prolonged and excessive inhalation of dust may cause lung disease, pneumoconiosis, with symptoms of shortness of breath and reduced pulmonary function. See "Cancer Status" in this Section

HEALTH HAZARDS:

Inhalation: Breathing prolonged and excessive amounts of kaolin dust may not cause noticeable injury or illness even though permanent lung damage may be occurring. Inhalation of dust may have the following serious chronic health effects:

Pneumoconiosis: Excessive inhalation of respirable dust may cause pneumoconiosis, a respiratory disease, which can result in delayed, progressive, disabling and sometimes fatal lung injury. Symptoms include cough, shortness of breath, wheezing, non-specific chest illness and reduced pulmonary function. This disease is exacerbated by smoking. Individuals with pneumoconiosis are predisposed to develop tuberculosis.

Cancer Status: The International Agency for Research on Cancer has determined that crystalline silica inhaled in the form of quartz or cristobalite from occupational sources is carcinogenic to humans (Group 1 - carcinogenic to humans). Refer to IARC Monograph 68, Silica, Some Silicates and Organic Fibres (published in June 1997) in conjunction with the use of these materials. The National Toxicology Program classifies respirable crystalline silica as "known to be a human carcinogen". Refer to the 9th Report on Carcinogens (2000). The American Conference of Governmental Industrial Hygienists (ACGIH) classifies crystalline silica, quartz, as a suspected human carcinogen (A2).

Other Data with Possible Relevance to Human Health:

There is some evidence that breathing respirable crystalline silica or the disease silicosis is associated with an increased incidence of significant disease endpoints such as scleroderma (an immune system disorder manifested by fibrosis of the lungs, skin and other internal organs) and kidney disease.

For further information consult "Adverse Effects of Crystalline Silica Exposure" published by the American Thoracic Society Medical Section of the American Lung Association, American Journal of Respiratory and Critical Care Medicine, Volume 155, pages 761-768, 1997.

Inhalation of dust may cause irritation of the nose, throat and respiratory passages.

Skin Contact: No adverse effects expected.

Eye Contact: Contact may cause mechanical irritation and possible injury.

Ingestion: No adverse effects expected for normal, incidental ingestion.

Chronic Health Effects: See "Inhalation" subsection above with respect to silicosis, cancer status and other data with possible relevance to human health.

Medical Conditions Aggravated by Exposure: Individuals with respiratory disease, including but not limited to, asthma and bronchitis, or subject to eye irritation should not be exposed to respirable quartz dust.

Signs and Symptoms of Exposure: There are generally no signs or symptoms of exposure to crystalline silica (quartz). See "Inhalation" subsection above for symptoms of silicosis.

SECTION 4: FIRST AID

Gross Inhalation: Remove victim to fresh air. If breathing has stopped, perform artificial respiration. If breathing is difficult have qualified personnel administer oxygen. Get prompt medical attention.

Skin Contact: No first aid should be needed since this product does not affect the skin. Wash exposed skin with soap and water before breaks and at the end of the shift.

Eye Contact: Flush the eyes immediately with large amounts of running water, lifting the upper and lower lids occasionally. If irritation persists or for imbedded foreign body, get immediate medical attention.

Ingestion: If large amounts are swallowed, get immediate medical attention.

SECTION 5: FIRE AND EXPLOSION DATA

Flash Point (Method Used): Fully oxidized, will not burn.

Autoignition Temp: Will not burn.

Flammable Limits: LEL: Not applicable UEL: Not applicable

Extinguishing Media: This product will not burn but is compatible with all extinguishing media. Use any media that is appropriate for the surrounding fire.

Special Fire Fighting Procedures: None required with respect to this product. Firefighters should always wear self-contained breathing apparatus for fires indoors or in confined areas.

Unusual Fire and Explosion Hazards: None.

Hazardous Combustion Products: None.

SECTION 6: ACCIDENTAL RELEASE MEASURES

Wear appropriate protective equipment. If uncontaminated, collect using dustless method (HEPA vacuum or wet method) and place in appropriate container for use. If contaminated: a) use appropriate method for the nature of contamination, b) consider possible toxic or fire hazards associated with the contaminating substances. Collect for disposal.

SECTION 7: HANDLING AND STORAGE

Do not breathe dust. Do not rely on your sight to determine if dust is in the air. Silica may be in the air without a visible dust cloud. Use normal precautions against bag breakage or spills of bulk material. Avoid creation of respirable dust. Use good housekeeping in storage and use areas to prevent accumulation of dust in work area.

Use adequate ventilation and dust collection. Maintain and use proper, clean respiratory equipment (See Section 8). Launder clothing that has become dusty. Empty containers (bags, bulk containers, storage tanks, etc.) retain silica residue and must be handled in accordance with the provisions of this Material Safety Data Sheet. WARN and TRAIN employees in accordance with state and federal regulations.

WARN YOUR EMPLOYEES (AND YOUR CUSTOMERS - USERS IN CASE OF RESALE) BY POSTING AND OTHER MEANS OF THE HAZARDS AND OSHA PRECAUTIONS TO BE USED. PROVIDE TRAINING FOR YOUR EMPLOYEES ABOUT OSHA PRECAUTIONS.

Additional information on silica hazards and precautionary measures can be found at the following websites:

NIOSH Joint Campaign on Silicosis Prevention <http://www.cdc.gov/niosh/sicampn.html>

OSHA Crystalline Silica Website <http://www.osha-slc.gov/SLTC/silicacrystalline/index.html>

MSHA Silicosis Prevention Website <http://www.msha.gov/S&HINFO/SILICO/SILICO.HTM>

SECTION 8: EXPOSURE CONTROLS/PERSONAL PROTECTION

Ventilation: Use local exhaust as required to maintain exposures below applicable occupational exposure limits (See Section 2). See also ACGIH "Industrial Ventilation - A Manual for Recommended Practice", (current edition).

Respiratory Protection: Use appropriate respiratory protection for respirable particulates based on consideration of airborne workplace concentrations and duration of exposure arising from intended end use. Refer to the most recent standards of ANSI (Z88.2), OSHA (29 CFR 1910.134), MSHA (30 CFR Parts 56 and 57) and NIOSH Respirator Decision Logic.

Gloves: Protective gloves recommended.

Eye Protection: Safety glasses or goggles recommended.

Other Protective Equipment/Clothing: As appropriate for the work environment. Dusty clothing should be laundered before reuse.

9: PHYSICAL AND CHEMICAL PROPERTIES

Appearance and Odor: White to cream colored slurry with a slight earthy odor.

pH: Not determined

Boiling Point: Not applicable

Melting Point: Not applicable

Solubility in Water: Negligible

Percent Volatile: Not determined

Specific Gravity (water=1): 1.78-2.58

Vapor Pressure: Not applicable

Vapor Density: Not applicable

Evaporation Rate: Not applicable

Fusion Range: 1569-1785°C

SECTION 10: STABILITY AND REACTIVITY

Stability: Stable

Conditions to Avoid: When exposed to high temperatures, free quartz can change crystal structures to form tridymite (above 870°C) or cristobalite (above 1470°C) which have greater health hazards than quartz.

Incompatibility: Powerful oxidizing agents such as fluorine, chlorine trifluoride, manganese trioxide, etc.

Hazardous Decomposition Products: Silica will dissolve in hydrofluoric acid producing a corrosive gas, silicon tetrafluoride.

Hazardous Polymerization: Will not occur.

Conditions to Avoid: None

SECTION 11: TOXICOLOGICAL INFORMATION

No acute toxicity data is available for product or components. Refer to Section 3 for health hazard information.

SECTION 12: ECOLOGICAL INFORMATION

No ecotoxicity data is available. This product is not expected to present an environmental hazard.

SECTION 13: DISPOSAL

Waste Disposal Method: If uncontaminated, dispose as an inert, non-metallic mineral. If contaminated, dispose in accordance with all applicable local, state/provincial and federal regulations.

SECTION 14: TRANSPORTATION DATA

U.S. DOT HAZARD CLASSIFICATION

Proper Shipping Name: Not Regulated
Technical Name: N/A
UN Number: N/A
Hazard Class/Packing Group: N/A
Labels Required: None
DOT Packaging Requirements: N/A
Exceptions: N/A

SECTION 15: OTHER REGULATORY INFORMATION

SARA 311/312: Hazard Categories for SARA Section 311/312 Reporting: Chronic Health

SARA 313 This Product Contains the Following Chemicals Subject to Annual Release Reporting Requirements Under the SARA Section 313 (40 CFR 372): None

CERCLA Section 103 Reportable Quantity: None

California Proposition 65: This product contains crystalline silica (respirable) which is known to the State of California to cause cancer.

Toxic Substances Control Act: All of the components of this product are listed on the EPA TSCA Inventory or exempt from notification requirements.

European Inventory of Commercial Chemical Substances: All of the components of this product are listed on the EINECS Inventory or exempt from notification requirements. (The EINECS number for Quartz: 231-545-4)

Canadian Environmental Protection Act: All the components of this product are listed on the Canadian Domestic Substances List or exempt from notification requirements.

Japan MITI: All of the components of this product are existing chemical substances as defined in the Chemical Substance Control Law.

Australian Inventory of Chemical Substances: All of the components of this product are listed on the AICS inventory or exempt from notification requirements.

Canadian WHMIS Classification: Class D, Division 2, Subdivision A (Very Toxic Material causing other Toxic Effects)

16: OTHER INFORMATION

European Community Labeling Classification: Harmful (Xn)

European Community Risk and Safety Phrases: R40, R48, S22

NFPA Hazard Rating: Health: 1 Fire: 0 Reactivity: 0

HMIS Hazard Rating: Health: * Fire: 0 Reactivity: 0

* Warning - Chronic health effect possible - inhalation of silica dust may cause lung injury/disease (silicosis). Take appropriate measures to avoid breathing dust. See Section 3.

References:

- Registry for Toxic Effects of Chemical Substances (RTECS), 1998
- Patty's Industrial Hygiene and Toxicology
- NTP Ninth Report on Carcinogens, 2000
- IARC Monograph Volume 68, Silica, Some Silicates and Organic Fibres, 1997

Revision Summary: New Product

The data in this Material Safety Data Sheet relates only to the specific material designated herein and does not relate to use in combination with any other material or in any process. The information set forth herein is based on technical data the Unimin Corporation believes reliable. It is intended for use by persons having technical skill and at their own discretion and risk. Since conditions of use are outside the control of Unimin Corporation, no warranties, expressed or implied, are made and no liability is assumed in connection with any use of this information. Any use of these data and information must be determined by the user to be in accordance with federal, state and local laws and regulations.

U. S. SILICA COMPANY

MSDS - MATERIAL SAFETY DATA SHEET

SECTION 1 - CHEMICAL PRODUCT AND COMPANY IDENTIFICATION

Product Names/Trade Names:

Silica Sand sold under various names: ASTM TESTING SANDS • GLASS SAND • FLINT SILICA • DM-SERIES • F-SERIES • FOUNDRY SANDS • FJ-SERIES • FP-SERIES • H-SERIES • L-SERIES • N-SERIES • NJ-SERIES • OK-SERIES • P-SERIES • T-SERIES • HYDRAULIC FRACING SANDS • MIN-U-SIL® Ground Silica • MYSTIC WHITE® • #1 DRY • #1 SPECIAL • PENN SAND® • Q-ROK® • SIL-CO-SIL® Ground Silica • SUPERSIL® • MASON SAND • GS-SERIES • PER-SPEC

Synonyms/Common Names: Sand, Silica Sand, Quartz, Crystalline Silica, Flint, Ground Silica.

Manufacturer's Name: U. S. Silica Company
P. O. Box 187
Berkeley Springs, WV 25411

Emergency Telephone Number: 304-258-2500 (8:30 am to 5:00 pm eastern)
304-258-8295 (fax)

Date Prepared: June 30, 2006 (revising February 10, 2005)

SECTION 2 - HAZARD IDENTIFICATION

EMERGENCY OVERVIEW:

The U. S. Silica Company material is a white or tan sand, or ground sand. It is not flammable, combustible or explosive. It does not cause burns or severe skin or eye irritation. A single exposure will not result in serious adverse health effects. Crystalline silica (quartz) is not known to be an environmental hazard.

Crystalline silica (quartz) is incompatible with hydrofluoric acid, fluorine, chlorine trifluoride or oxygen difluoride.

OSHA REGULATORY STATUS

This material is considered hazardous under the OSHA Hazard Communications Standard (29 CFR 1910.1200).

POTENTIAL HEALTH EFFECTS:

Inhalation:

- a. Silicosis Respirable crystalline silica (quartz) can cause silicosis, a fibrosis (scarring) of the lungs. Silicosis may be progressive; it may lead to disability and death.
- b. Lung Cancer Crystalline silica (quartz) inhaled from occupational sources is classified as carcinogenic to humans.
- c. Tuberculosis Silicosis increases the risk of tuberculosis.
- d. Autoimmune and Chronic Kidney Diseases Some studies show excess numbers of cases of scleroderma, connective tissue disorders, lupus, rheumatoid arthritis, chronic kidney diseases and end-stage kidney disease in workers exposed to respirable crystalline silica.
- e. Non-Malignant Respiratory Diseases (other than silicosis) Some studies show an increased incidence in chronic bronchitis and emphysema in workers exposed to respirable crystalline silica.

Eye Contact: Crystalline silica (quartz) may cause abrasion of the cornea.

Skin Contact: Not applicable.

Ingestion: Not applicable.

Chronic Effects: The adverse health effects -- silicosis, lung cancer, autoimmune and chronic kidney diseases, tuberculosis, and non-malignant respiratory diseases-- are chronic effects.

Signs and Symptoms of Exposure: Generally, there are no signs or symptoms of exposure to crystalline silica (quartz).

Medical Conditions Generally Aggravated by Exposure: The condition of individuals with lung disease (e.g., bronchitis, emphysema, chronic obstructive pulmonary disease) can be aggravated by exposure.

See Section 11, Toxicological Information, for additional detail on potential adverse health effects.

SECTION 3 - COMPOSITION/INFORMATION ON INGREDIENTS

Ingredients:

	<u>Chemical Formula</u>	<u>Typical %, By Weight</u>	<u>CAS #</u>
Crystalline Silica (quartz)	SiO ₂	99.0 - 99.9	14808-60-7
Aluminum Oxide	Al ₂ O ₃	< .8	1344-28-1
Iron Oxide	Fe ₂ O ₃	< .1	1309-37-1
Titanium Oxide	TiO ₂	< .1	13463-67-7

SECTION 4 - FIRST AID MEASURES

Inhalation: No specific first-aid is necessary since the adverse health effects associated with exposure to crystalline silica (quartz) result from chronic exposures. If there is a gross inhalation of crystalline silica (quartz), remove the person immediately to fresh air, give artificial respiration as needed, seek medical attention as needed.

Eye Contact: Wash immediately with water. If irritation persists, seek medical attention.

Skin Contact: Not applicable.

Ingestion: Not applicable.

SECTION 5 - FIRE FIGHTING MEASURES

Crystalline silica (quartz) is not flammable, combustible or explosive.

SECTION 6 - ACCIDENTAL RELEASE MEASURES

Spills: Use dustless methods (vacuum) and place into closable container for disposal, or flush with water. Do not dry sweep. Wear protective equipment specified below.

Waste Disposal Method: See Section 13.

SECTION 7 - HANDLING AND STORAGE

Precautions During Handling and Use: Do not breathe dust. Use adequate ventilation and dust collection. Keep airborne dust concentrations below permissible exposure limit ("PEL"). Do not rely on your sight to determine if dust is in the air. Respirable crystalline silica dust may be in the air without a visible dust cloud.

If crystalline silica dust cannot be kept below permissible limits, wear a respirator approved for silica dust when using, handling, storing or disposing of this product or bag. See Section 8 for further information on respirators. Practice good housekeeping. Do not permit dust to collect on walls, floors, sills, ledges, machinery, or equipment. Maintain, clean, and fit test respirators in accordance with OSHA regulations. Maintain and test ventilation and dust collection equipment. Wash or vacuum clothing that has become dusty.

The OSHA Hazard Communication Standard, 29 CFR Sections 1910.1200, 1915.1200, 1917.28, 1918.90, 1926.59 and 1928.21, and state and local worker or community "right-to-know" laws and regulations should be strictly followed.

Do not use U. S. Silica Company materials for sandblasting.

Precautions During Storage: Avoid breakage of bagged material or spills of bulk material. Use dustless methods (vacuum) and place into closable container for disposal, or flush with water. Do not dry sweep. See control measures in Section 8.

The OSHA Hazard Communication Standard, 29 CFR Sections 1910.1200, 1915.1200, 1917.28, 1918.90, 1926.59 and 1928.21, and state and local worker or community "right-to-know" laws and regulations should be strictly followed. **WARN YOUR EMPLOYEES (AND YOUR CUSTOMERS IN CASE OF RESALE) BY POSTING AND OTHER MEANS OF THE HAZARDS AND THE REQUIRED OSHA PRECAUTIONS. PROVIDE TRAINING FOR YOUR EMPLOYEES ABOUT THE OSHA PRECAUTIONS.**

For additional precautions, see American Society for Testing and Materials (ASTM) standard practice E 1132-99a, "Standard Practice for Health Requirements Relating to Occupational Exposure to Respirable Crystalline Silica."

SECTION 8 - EXPOSURE CONTROLS/PERSONAL PROTECTION

Local Exhaust Ventilation: Use sufficient local exhaust ventilation to reduce the level of respirable crystalline silica to below the OSHA PEL. See ACGIH "Industrial Ventilation, A Manual of Recommended Practice" (latest edition).

Respiratory Protection:

If it is not possible to reduce airborne exposure levels to below the OSHA PEL with ventilation, use the table below to assist you in selecting respirators that will reduce personal exposures to below the OSHA PEL. This table is part of the NIOSH Respirator Selection Logic, 2004, Chapter III, Table 1, "Particulate Respirators". The full document can be found at www.cdc.gov/niosh/npptl/topics/respirators; the user of this MSDS is directed to that site for information concerning respirator selection and use.

The assigned protection factor (APF) is the minimum anticipated level of protection provided by each type of respirator worn in accordance with an adequate respiratory protection program. For example, an APF of 10 means that the respirator should reduce the airborne concentration of a particulate by a factor of 10, so that if the workplace concentration of a particulate was 150 ug/m³, then a respirator with an APF of 10 should reduce the concentration of particulate to 15 ug/m³.

Assigned protection factor ¹	Type of Respirator (Use only NIOSH-certified respirators)
10	Any air-purifying elastomeric half-mask respirator equipped with appropriate type of particulate filter. ² Appropriate filtering facepiece respirator. ^{2,3} Any air-purifying full facepiece respirator equipped with appropriate type of particulate filter. ² Any negative pressure (demand) supplied-air respirator equipped with a half-mask.
25	Any powered air-purifying respirator equipped with a hood or helmet and a high efficiency (HEPA) filter. Any continuous flow supplied-air respirator equipped with a hood or helmet.
50	Any air-purifying full facepiece respirator equipped with N-100, R-100, or P-100 filter(s). Any powered air-purifying respirator equipped with a tight-fitting facepiece (half or full facepiece) and a high-efficiency filter. Any negative pressure (demand) supplied-air respirator equipped with a full facepiece. Any continuous flow supplied-air respirator equipped with a tight-fitting facepiece (half or full facepiece). Any negative pressure (demand) self-contained respirator equipped with a full facepiece.
1,000	Any pressure-demand supplied-air respirator equipped with a half-mask.

1. The protection offered by a given respirator is contingent upon (1) the respirator user adhering to complete program requirements (such as the ones required by OSHA in 29CFR1910.134), (2) the use of NIOSH-certified respirators in their approved configuration, and (3) individual fit testing to rule out those respirators that cannot achieve a good fit on individual workers.
 2. Appropriate means that the filter medium will provide protection against the particulate in question.
 3. An APF of 10 can only be achieved if the respirator is qualitatively or quantitatively fit tested on individual workers.

Exposure Guidelines:

Component	CAS No.	Percentage (by wt.)	OSHA PEL		ACGIH TLV		NIOSH REL		Unit
			TWA	STEL	TWA	STEL	TWA	STEL	
Crystalline Silica (quartz)	14808-60-7	99.0-99.9	$\frac{10}{\% \text{ SiO}_2 + 2}$	None	.025	None	.05	None	mg/m ³

If crystalline silica (quartz) is heated to more than 870°C, it can change to a form of crystalline silica known as tridymite; if crystalline silica (quartz) is heated to more than 1470°C, it can change to a form of crystalline silica known as cristobalite. The OSHA PEL for crystalline silica as tridymite or cristobalite is one-half of the OSHA PEL for crystalline silica (quartz).

SECTION 9 - PHYSICAL AND CHEMICAL PROPERTIES

Appearance:	White or tan sand; granular, crushed, or ground.		
Boiling Point:	4046°F/2230°C	Odor:	None
Vapor Pressure (mm Hg.):	None	Specific Gravity (Water = 1):	2.65
Vapor Density (Air = 1):	None	Melting Point:	3110°F/1710°C
Solubility in Water:	Insoluble in water	Evaporation Rate (Butyl Acetate = 1):	None

SECTION 10 - STABILITY AND REACTIVITY

Stability: Crystalline silica (quartz) is stable.

Incompatibility (Materials to Avoid): Contact with powerful oxidizing agents, such as fluorine, chlorine trifluoride and oxygen difluoride, may cause fires.

Hazardous Decomposition or Byproducts: Silica will dissolve in hydrofluoric acid and produce a corrosive gas - silicon tetrafluoride.

Hazardous Polymerization: Will not occur.

SECTION 11 - TOXICOLOGICAL INFORMATION

The method of exposure to crystalline silica that can lead to the adverse health effects described below is inhalation.

A. SILICOSIS

The major concern is silicosis, caused by the inhalation and retention of respirable crystalline silica dust. Silicosis can exist in several forms, chronic (or ordinary), accelerated, or acute.

Chronic or Ordinary Silicosis (often referred to as Simple Silicosis) is the most common form of silicosis, and can occur after many years of exposure to relatively low levels of airborne respirable crystalline silica dust. It is further defined as either simple or complicated silicosis.

Simple silicosis is characterized by lung lesions (shown as radiographic opacities) less than 1 centimeter in diameter, primarily in the upper lung zones. Often, simple silicosis is not associated with symptoms, detectable changes in lung function or disability.

Simple silicosis may be progressive and may develop into complicated silicosis or progressive massive fibrosis (PMF). Complicated silicosis or PMF is characterized by lung lesions (shown as radiographic opacities) greater than 1 centimeter in diameter. Although there may be no symptoms associated with complicated silicosis or PMF, the symptoms, if present, are shortness of breath, wheezing, cough and sputum production. Complicated silicosis or PMF may be associated with decreased lung function and may be disabling. Advanced complicated silicosis or PMF may lead to death. Advanced complicated silicosis or PMF can result in heart disease secondary to the lung disease (cor pulmonale).

Accelerated Silicosis can occur with exposure to high concentrations of respirable crystalline silica over a relatively short period; the lung lesions can appear within five (5) years of initial exposure. Progression can be rapid. Accelerated silicosis is similar to chronic or ordinary silicosis, except that lung lesions appear earlier and progression is more rapid.

Acute Silicosis can occur with exposures to very high concentrations of respirable crystalline silica over a very short time period, sometimes as short as a few months. The symptoms of acute silicosis include progressive shortness of breath, fever, cough and weight loss. Acute silicosis is fatal.

B. CANCER

IARC - The International Agency for Research on Cancer ("IARC") concluded that there was "*sufficient evidence* in humans for the carcinogenicity of crystalline silica in the forms of quartz or cristobalite from occupational sources", and that there is "*sufficient evidence* in experimental animals for the carcinogenicity of quartz and cristobalite." The overall IARC evaluation was that "crystalline silica inhaled in the form of quartz or cristobalite from occupational sources is *carcinogenic to humans (Group 1)*." The IARC evaluation noted that "carcinogenicity was not detected in all industrial circumstances studies. Carcinogenicity may be dependent on inherent characteristics of the crystalline silica or on external factors affecting its biological activity or distribution of its polymorphs." For further information on the IARC evaluation, see IARC Monographs on the Evaluation of Carcinogenic Risks to Humans, Volume 68, "Silica, Some Silicates..." (1997).

NTP - The National Toxicology Program's Eleventh Annual Report on Carcinogens classifies "silica, crystalline (respirable size)" as a known human carcinogen.

OSHA - Crystalline silica (quartz) is not regulated by the U. S. Occupational Safety and Health Administration as a carcinogen.

C. AUTOIMMUNE DISEASES

Several studies have reported excess cases of several autoimmune disorders, -- scleroderma, systemic lupus erythematosus, rheumatoid arthritis -- among silica-exposed workers. For a review of the subject, the following may be consulted: "Occupational Exposure to Crystalline Silica and Autoimmune Disease", Environmental Health Perspectives, Volume 107, Supplement 5, pp. 793-802 (1999); "Occupational Scleroderma", Current Opinion in Rheumatology, Volume 11, pp. 490-494 (1999).

D. TUBERCULOSIS

Individuals with silicosis are at increased risk to develop pulmonary tuberculosis, if exposed to persons with tuberculosis. The following may be consulted for further information: Occupational Lung Disorders, Third Edition, Chapter 12, entitled "Silicosis and Related Diseases", Parkes, W. Raymond (1994); "Risk of pulmonary tuberculosis relative to silicosis and exposure to silica dust in South African gold miners," Occup Environ Med., Volume 55, pp.496-502 (1998).

E. KIDNEY DISEASE

Several studies have reported excess cases of kidney diseases, including end stage renal disease, among silica-exposed workers. For additional information on the subject, the following may be consulted: "Kidney Disease and Silicosis", Nephron, Volume 85, pp. 14-19 (2000).

F. NON-MALIGNANT RESPIRATORY DISEASES

The reader is referred to Section 3.5 of the NIOSH Special Hazard Review cited below, for information concerning the association between exposure to crystalline silica and chronic bronchitis, emphysema and small airways disease. There are studies that disclose an association between dusts found in various mining occupations and non-malignant respiratory diseases, particularly among smokers. It is unclear whether the observed associations exist only with underlying silicosis, only among smokers, or result from exposure to mineral dusts generally (independent of the presence or absence of crystalline silica, or the level of crystalline silica in the dust).

Sources of information:

The NIOSH Hazard Review - Occupational Effects of Occupational Exposure to Respirable Crystalline Silica published in April 2002 summarizes and discusses the medical and epidemiological literature on the health risks and diseases associated with occupation exposures to respirable crystalline silica. The NIOSH Hazard Review should be consulted for additional information, and citations to published studies on health risks and diseases associated with occupational exposure to respirable crystalline silica. The NIOSH Hazard Review is available from NIOSH - Publications Dissemination, 4676 Columbia Parkway, Cincinnati, OH 45226, or by calling 1-800-35-NIOSH (1-800-356-4676), or through the NIOSH web site, www.cdc.gov/niosh/topics/silica, then click on the link "NIOSH Hazard Review: Health Effects of Occupational Exposure to Respirable Crystalline Silica".

SECTION 12 - ECOLOGICAL INFORMATION

Crystalline silica (quartz) is not known to be ecotoxic; i.e., there are no data that suggests that crystalline silica (quartz) is toxic to birds, fish, invertebrates, microorganisms or plant

SECTION 13 - DISPOSAL CONSIDERATIONS

General: The packaging and material may be landfilled; however, material should be covered to minimize generation of airborne dust.

RCRA: Crystalline silica (quartz) is not classified as a hazardous waste under the Resource Conservation and Recovery Act, or its regulations, 40 CFR §261 et seq.

The above applies to materials as sold by U. S. Silica Company. The material may be contaminated during use, and it is the responsibility of the user to assess the appropriate disposal of the used material.

SECTION 14 - TRANSPORT INFORMATION

Crystalline silica (quartz) is not a hazardous material for purposes of transportation under the U. S. Department of Transportation Table of Hazardous Materials, 49 CFR §172.101.

SECTION 15 - REGULATORY INFORMATION

UNITED STATES (FEDERAL AND STATE)

TSCA No.: Crystalline silica (quartz) appears on the EPA TSCA inventory under the CAS No. 14808-60-7.

RCRA: Crystalline silica (quartz) is not classified as a hazardous waste under the Resource Conservation and Recovery Act, or its regulations, 40 CFR §261 et seq.

CERCLA: Crystalline silica (quartz) is not classified as a hazardous substance under regulations of the Comprehensive Environmental Response Compensation and Liability Act (CERCLA), 40 CFR §302.

Emergency Planning and Community Right to Know Act (SARA Title III): Crystalline silica (quartz) is not an extremely hazardous substance under Section 302 and is not a toxic chemical subject to the requirements of Section 313.

Clean Air Act: Crystalline silica (quartz) mined and processed by U.S. Silica Company is not processed with or does not contain any Class I or Class II ozone depleting substances.

FDA: Silica is included in the list of substances that may be included in coatings used in food contact surfaces, 21 CFR §175.300(b)(3)(xxvi).

NTP: Respirable crystalline silica, primarily quartz dusts occurring in industrial and occupational settings, is classified as Known to be a Human Carcinogen.

OSHA Carcinogen: Crystalline silica (quartz) is not listed.

California Proposition 65: Crystalline silica (airborne particles of respirable size) is classified as a substance known to the State of California to be a carcinogen.

California Inhalation Reference Exposure Level (REL): California established a chronic REL of 3 ug for silica (crystalline, respirable). A chronic REL is an airborne level of a substance at or below which no adverse health effects are anticipated in individuals indefinitely exposed to the substance at that level.

Massachusetts Toxic Use Reduction Act: Silica, crystalline (respirable size, <10 microns) is “toxic” for purposes of the Massachusetts Toxic Use Reduction Act.

Pennsylvania Worker and Community Right to Know Act: Quartz is a hazardous substance under the Act, but it is not a special hazardous substance or an environmental hazardous substance.

CANADA

Domestic Substances List: U. S. Silica Company products, as naturally occurring substances, are on the Canadian DSL.

WHMIS Classification: D2A

OTHER

EINECS No.: 238-878-4

EEC Label (Risk/Safety Phrases): R 48/20, R 40/20, S22, S38

IARC: Crystalline silica (quartz) is classified in IARC Group 1.

Japan MITI: All of the components of this product are existing chemical substances as defined in the Chemical Substance Control Law.

Australian Inventory of Chemical Substances: All of the components of this product are listed on the AICS inventory or exempt from notification requirements.

National, state, provincial or local emergency planning, community right-to-know or other laws, regulations or ordinances may be applicable--consult applicable national, state, provincial or local laws.

SECTION 16 - OTHER INFORMATION

Hazardous Material Information System (HMIS):

Health	*
Flammability	0
Reactivity	0
Protective Equipment	E

* For further information on health effects, see Sections 2 and 11 of this MSDS.

National Fire Protection Association (NFPA):

Health	0
Flammability	0
Reactivity	0

Web Sites with Information about Effects of Crystalline Silica Exposure:

The U. S. Silica web site will provide updated links to OSHA and NIOSH web sites addressing crystalline silica issues. www.u-s-silica.com, click in "Information", then click on "Health & Safety".

U. S. SILICA COMPANY DISCLAIMER

The information and recommendations contained herein are based upon data believed to be correct. However, no guarantee or warranty of any kind, express or implied, is made with respect to the information contained herein. We accept no responsibility and disclaim all liability for any harmful effects that may be caused by purchase, resale, use or exposure to our silica. Customers-users of silica must comply with all applicable health and safety laws, regulations, and orders, including the OSHA Hazard Communication Standard.



MATERIAL SAFETY DATA SHEET

MSDS No. M0372

Effective Date: 10/05/2007

1. IDENTIFICATION OF THE PRODUCT AND OF THE COMPANY

Trade Names: ISOFRAX® 1260C PAPER
Chemical Name: ALKALINE EARTH SILICATE WOOL (AES)
Synonym(s): Synthetic vitreous fiber (SVF), man-made vitreous fiber (MMVF), man-made mineral fiber (MMMf), alkaline-earth-silicate fiber, magnesium silicate fiber
Manufacturer/Supplier: Unifrax I LLC
 2351 Whirlpool St.
 Niagara Falls, NY 14305-2413
Product Stewardship Information Hotline
 1-800-322-2293 (Monday - Friday 8:00 a.m. - 4:30 p.m. EST)
 For additional MSDSs, visit our web page, <http://www.unifrax.com>, or call Unifrax Customer Service at (716) 278-3872
CHEMTREC Assist: CHEMTREC will provide assistance for chemical emergencies. Call 1-800-424-9300

2. COMPOSITION / INFORMATION ON INGREDIENTS

<u>COMPONENTS</u>	<u>CAS NUMBER</u>	<u>% BY WEIGHT</u>
Amorphous alkaline-earth-silicate (magnesium-silicate) wool (SiO ₂ 70-80 %, MgO 18-27 %, trace elements 0-4%)	436083-99-7	80-90
Acrylic latex	MIXTURE 10043-01-3	5-10 0-5
Aluminum sulfate		

(See Section 8 "Exposure Controls / Personal Protection" for exposure guidelines)

3. HAZARDS IDENTIFICATION

MAY IRRITATE EYES, SKIN and RESPIRATORY TRACT

May cause temporary mechanical irritation to eyes, skin, and respiratory tract (nose, throat & lungs).

Pre-existing medical conditions, including dermatitis, asthma or chronic lung disease may be aggravated by exposure; individuals who are atopic (with a history of allergies) may experience greater amounts of skin and respiratory irritation.

HAZARD CLASSIFICATION

The Hazardous Materials Identification System (HMIS) –

Health 1 Flammability 0 Reactivity 0 Personal Protection Index: X (Employer Determined)

4. FIRST AID MEASURES

FIRST AID PROCEDURES

RESPIRATORY TRACT (nose & throat) IRRITATION:

If respiratory tract irritation develops, move the person to a dust free location. Get medical attention if the irritation continues. See Section 8 for additional measures to reduce or eliminate exposure.

EYE IRRITATION:

If eyes become irritated, flush immediately with large amounts of lukewarm water for at least 15 minutes. Eyelids should be held away from the eyeball to ensure thorough rinsing. Do not rub eyes. Get medical attention if irritation persists.

SKIN IRRITATION:

If skin becomes irritated, remove soiled clothing. Do not rub or scratch exposed skin. Wash area of contact thoroughly with soap and water. Using a skin cream or lotion after washing may be helpful.

GASTROINTESTINAL IRRITATION:

If gastrointestinal tract irritation develops, move the person to a dust free environment.

NOTES TO PHYSICIANS:

Skin and respiratory effects are the result of temporary, mild mechanical irritation; fiber exposure does not result in allergic manifestations.

5. FIRE FIGHTING MEASURES

Non-combustible (does not burn) product.

Packaging and surrounding materials may be combustible.
Use extinguishing agent suitable for surrounding combustible materials.

6. ACCIDENTAL RELEASE MEASURES

SPILL PROCEDURES

Avoid creating airborne dust. Dust suppressing cleaning methods such as wet sweeping or vacuuming should be used to clean the work area. If vacuuming, the vacuum must be equipped with a HEPA filter. Compressed air or dry sweeping should not be used for cleaning.

7. HANDLING AND STORAGE

STORAGE

Store in original container in a dry area. Keep container closed when not in use.

HANDLING

Handle fiber carefully. Limit use of power tools unless in conjunction with local exhaust. Use hand tools whenever possible. Frequently clean the work area with HEPA filtered vacuum or wet sweeping to minimize the accumulation of debris. Do not use compressed air for clean-up.

EMPTY CONTAINERS

Product packaging may contain residue. Do not reuse.

8. EXPOSURE CONTROL / PERSONAL PROTECTION

INDUSTRIAL HYGIENE STANDARDS AND OCCUPATIONAL EXPOSURE LIMITS

COMPONENTS	OSHA PEL	MANUFACTURER REG
Amorphous alkaline-earth-silicate (magnesium-silicate) wool	None established	See below**
Acrylic latex	None established	None established
Aluminum sulfate	None established	None established

There is no specific regulatory standard for ISOFRAX® in the U.S. OSHA's "Particulate Not Otherwise Regulated (PNOR)" standard [29 CFR 1910.1000, Subpart Z, Air Contaminants] applies generally; Total Dust 15 mg/m³; Respirable Fraction 5 mg/m³.

OTHER OCCUPATIONAL EXPOSURE LEVELS (OEL)

ACGIH TLV's : Amorphous alkaline-earth-silicate (magnesium-silicate) wool -- Particulates Not Otherwise Classified (PNOC) : Inhalable particulate -- 10 mg/m³. Respirable particulate -- 3 mg/m³. Acrylic latex -- None established. Aluminum sulfate -- None established.

** As with most industrial materials, it is prudent to minimize unnecessary exposure to respirable dusts. Note that Industrial hygiene standards and occupational exposure limits differ between countries and local jurisdictions. Check with your employer to identify any "respirable dust", "total dust" or "fiber" exposure standards to follow in your area. If no regulatory dust or fiber control standard apply, a qualified industrial hygiene professional can assist with a specific evaluation of workplace conditions and the identification of appropriate respiratory protection practices. In the absence of other guidance, the supplier has found that it is generally feasible to control occupational fiber exposure to 1 f/cc or less.

ENGINEERING CONTROLS:

Dust suppressing control technologies such as local exhaust ventilation, point of generation dust collection, down draft work stations, emission controlling tool designs, and materials handling equipment are effective means of minimizing airborne fiber emissions. For additional information, contact the Unifrax Product Stewardship Information Line at 1-800-322-2293 (See Section 16).

PERSONAL PROTECTION EQUIPMENT

Skin Protection:

Wear gloves, head coverings and full body clothing as necessary to prevent skin irritation. Washable or disposable clothing may be used. If possible, do not take unwashed clothing home. If soiled work clothing must be taken home, employers should ensure employees are thoroughly trained on the best practices to minimize or avoid non-work dust exposure (e.g., vacuum clothes before leaving the work area, wash work clothing separately, rinse washer before washing other household clothes, etc.).

Eye Protection:

Wear safety glasses with side shields or other forms of eye protection in compliance with appropriate OSHA standards to prevent eye irritation. The use of contact lenses is not recommended, unless used in conjunction with appropriate eye protection. Do not touch eyes with soiled body parts or materials. If possible, have eye-washing facilities readily available where eye irritation can occur.

Respiratory Protection:

When effective engineering and/or administrative controls are insufficient, the use of appropriate respiratory protection, pursuant to the requirements of OSHA 1910.134, is recommended. For dust concentrations below the applicable exposure limit value, PPE is not required. The evaluation of workplace hazards and the identification of appropriate respiratory protection is best performed on a case by case basis, by a qualified Industrial Hygienist.

9. PHYSICAL AND CHEMICAL PROPERTIES

ODOR AND APPEARANCE:	White, odorless, fibrous material
CHEMICAL FAMILY:	Alkaline Earth Silicate Wool (AES) Magnesium Silicate
BOILING POINT:	Not Applicable
WATER SOLUBILITY (%):	Not Soluble in Water
MELTING POINT:	1500-1550°C (2730-2820°F)
SPECIFIC GRAVITY:	2.60
VAPOR PRESSURE:	Not Applicable
pH:	Not Applicable
VAPOR DENSITY (Air = 1):	Not Applicable
% VOLATILE:	Not Applicable
MOLECULAR FORMULA:	SiO ₂ MgO.

10. STABILITY AND REACTIVITY

CHEMICAL STABILITY:	Stable under conditions of normal use.
INCOMPATIBILITY:	Avoid direct contact with strong acid environments.
CONDITIONS TO AVOID:	None.
HAZARDOUS DECOMPOSITION PRODUCTS:	
HAZARDOUS POLYMERIZATION:	Not Applicable.

11. TOXICOLOGICAL INFORMATION

EPIDEMIOLOGY

This product has not been the subject of epidemiological study. Epidemiological studies related to other fiber chemistries of similar solubility have not identified a statistically significant incidence of exposure-related respiratory disease.

TOXICOLOGY

This product has been the subject of limited testing.

A review of available scientific literature suggests an inverse relationship between dissolution rate and potential health effects; i.e. the higher the dissolution rate of a fiber the lower its potential to produce health effects. The dissolution rate of ISOFRAX® fiber has been determined through standardized *in vitro* testing. The dissolution rate of ISOFRAX® fibers is higher than that of other fiber types that have been tested in chronic animal studies and did not produce respiratory disease.

This product possesses a fiber chemistry within the regulatory (European Commission Directive 97/69/EC) definition as a "man-made vitreous (silicate) fiber with random orientation with alkaline oxide and alkaline earth oxide (Na₂O + K₂O + CaO + MgO + BaO) content greater than 18% by weight". ISOFRAX® fibers have been tested pursuant to EU protocol ECB/TM/26, rev. 7, Nota Q, Directive 97/69/EC. The results for the short term biopersistence test by inhalation (IH test) was 6 days; well below the regulatory threshold of 10 days cited in Directive 97/69/EC. Based on testing results, ISOFRAX® based products are not regarded as potential carcinogens and they ARE EXEMPT from European classification as such. By virtue of these test results, these products ARE EXEMPT from European regulatory guidelines that require hazard warning labels with specific risk phrases citing respiratory disease potential. In addition, ISOFRAX® fibers have been tested in an independent laboratory, by intratracheal (IT test) instillation, under a protocol that was consistent with the requirements of the German Hazardous Substances Ordinance (BGBI. I pp. 1782, 2049, Third Amendment, Appendix V, No. 7). The half-life clearance of Isofrax® fibers was 32.7 days; well below the applicable regulatory thresholds. Based on the IT test results, Isofrax products ARE EXEMPT from the requirements of the German Ordinance.

The definition of "irritant" contained in the hazard communication standard, 29 CFR 1900.1200, Appendix A, is "...a reversible inflammatory effect on living tissue by chemical action...". ISOFRAX® fiber is an inert material which doesn't interact chemically

with exposed skin. However, there is a possibility that exposure to this product may cause temporary mechanical irritation to the eyes, skin or respiratory tract (nose, throat, lungs). This temporary irritation can be mitigated with proper handling practices designed to limit exposure and the use of protective clothing (glasses, gloves, clothing).

This product has not been specifically evaluated by any regulatory authority or other classification entity, such as the International Agency for Research on Cancer (IARC) or the National Toxicology Program (NTP). Other types of man-made vitreous fibers (MMVF) have been evaluated and subsequently classified as potential carcinogens. Various classifications, such as "possible carcinogen", "probable carcinogen", and "reasonably anticipated to be a carcinogen" have been given to other MMVF's.

12. ECOLOGICAL INFORMATION

No ecological concerns have been identified.

13. DISPOSAL CONSIDERATIONS

WASTE MANAGEMENT

To prevent waste materials from becoming airborne during waste storage, transportation and disposal, a covered container or plastic bagging is recommended.

DISPOSAL

ISOFRAX® fiber, as manufactured, is not classified as a hazardous waste according to Federal regulations (40 CFR 261). Any processing, use, alteration or chemical additions to the product, as purchased, may alter the disposal requirements. Under Federal regulations, it is the waste generator's responsibility to properly characterize a waste material, to determine if it is a "hazardous" waste. Check local, regional, state or provincial regulations to identify all applicable disposal requirements.

EUROPEAN UNION

Waste from this product is not classified as "hazardous" or "special" under European Union regulations. Disposal is permitted at landfills licensed for industrial waste.

14. TRANSPORT INFORMATION

U.S. DEPARTMENT OF TRANSPORTATION (DOT)

Hazard Class:	Not Regulated	United Nations (UN) Number:	Not Applicable
Labels:	Not Applicable	North America (NA) Number:	Not Applicable
Placards:	Not Applicable	Bill of Lading:	Product Name

INTERNATIONAL

Canadian TDG Hazard Class & PIN: Not regulated
Not classified as dangerous goods under ADR (road), RID (train) or IMDG (ship).

15. REGULATORY INFORMATION

UNITED STATES REGULATIONS

EPA: **Superfund Amendments and Reauthorization Act (SARA)** Title III - This product does not contain any substances reportable under Sections 302, 304, 313, (40 CFR 372). Sections 311 and 312 (40 CFR 370) apply (delayed hazard).
Toxic Substances Control Act (TSCA) - All substances in this product are listed, as required, on the TSCA inventory.

Comprehensive Environmental Response, Compensation and Liability Act

(**CERCLA**) and the **Clean Air Act (CAA)** - ISOFRAX® contains fibers with an average diameter greater than one micron and thus is not considered a hazardous air pollutant.

OSHA: Comply with **Hazard Communication Standards** 29 CFR 1910.1200 and 29 CFR 1926.59 and the **Respiratory Protection Standards** 29 CFR 1910.134 and 29 CFR 1926.103.

States: ISOFRAX® products are not known to be regulated. However, state and local OSHA and EPA regulations may apply to these products. If in doubt, contact your local regulatory agency.

INTERNATIONAL REGULATIONS

Canada: **Canadian Workplace Hazardous Materials Information System (WHMIS):**

No Canadian Workplace Hazardous Materials Information System (WHMIS) categories apply to this product.

Canadian Environmental Protection Act (CEPA) - All substances in this product are listed, as required, on the Domestic Substance List (DSL)

European Union: **European Directive 97/69/EC** - By virtue of testing results, ISOFRAX® fiber has

been exempted from classification and labeling as a potential carcinogen.

16. OTHER INFORMATION

After-Service ISOFRAX® Thermal Insulation: Removal

As produced, Isofrax fibers are vitreous (glassy) materials, which upon continued exposure to elevated temperatures (above about 800°C) might devitrify, initially forming magnesia-bearing phases (enstatite). At higher temperatures, (above about 1000°C) crystalline phase silicas may occur. The occurrence and extent of crystalline phase formation is dependent on the duration and temperature of exposure, fiber chemistry and/or the presence of fluxing agents. The presence of crystalline phases can be confirmed only through laboratory analysis of the "hot-face" fiber.

IARC's evaluation of crystalline silica states "Crystalline silica inhaled in the form of quartz or cristobalite from occupational sources is carcinogenic to humans (Group 1)" and additionally notes "carcinogenicity in humans was not detected in all industrial circumstances studied" (IARC Monograph Vol. 68, 1997). NTP lists all polymorphs of crystalline silica amongst substances which may "reasonably be anticipated to be carcinogens".

During removal operations, the use of a full face respirator is recommended to reduce inhalation exposure along with eye & respiratory tract irritation. A specific evaluation of workplace hazards and the identification of appropriate respiratory protection is best performed, on a case by case basis, by a qualified industrial hygiene professional. For more detailed information regarding respirable crystalline silica, call the Product Stewardship Information Hotline (see below).

PRODUCT STEWARDSHIP PROGRAM

Unifrax has established a program to provide customers with up-to-date information regarding the proper use and handling of fiber-based products, including ISOFRAX® THERMAL INSULATION. In addition, Unifrax has also established a program to monitor airborne fiber concentrations at customer facilities. If you would like more information about this program, please call the Unifrax Product Stewardship Information Line at 1-800-322-2293.

DEFINITIONS

ACGIH: American Conference of Governmental Industrial Hygienists

ADR:	Carriage of Dangerous Goods by Road (International Regulation)
CAA:	Clean Air Act
CAS:	Chemical Abstracts Service
CERCLA:	Comprehensive Environmental Response, Compensation and Liability Act
DSL:	Domestic Substances List
EPA:	Environmental Protection Agency
EU:	European Union
f/cc:	Fibers per cubic centimeter
HEPA:	High Efficiency Particulate Air
HMIS:	Hazardous Materials Identification System
IARC:	International Agency for Research on Cancer
IATA:	International Air Transport Association
IMDG:	International Maritime Dangerous Goods Code
mg/m³:	Milligrams per cubic meter of air
mmpcf:	Million particles per cubic meter
NFPA:	National Fire Protection Association
NIOSH:	National Institute for Occupational Safety and Health
OSHA:	Occupational Safety and Health Administration
29 CFR 1910.134 & 1926.103:	OSHA Respiratory Protection Standards
29 CFR 1910.1200 & 1926.59:	OSHA Hazard Communication Standards
PEL:	Permissible Exposure Limit (OSHA)
PIN:	Product Identification Number
PNOC:	Particulates Not Otherwise Classified
PNOR:	Particulates Not Otherwise Regulated
PSP:	Product Stewardship Program
RCRA:	Resource Conservation and Recovery Act
REL:	Recommended Exposure Limit (NIOSH)
RID:	Carriage of Dangerous Goods by Rail (International Regulations)
SARA:	Superfund Amendments and Reauthorization Act
SARA Title III:	Emergency Planning and Community Right to Know Act
SARA Section 302:	Extremely Hazardous Substances
SARA Section 304:	Emergency Release
SARA Section 311:	MSDS/List of Chemicals and Hazardous Inventory
SARA Section 312:	Emergency and Hazardous Inventory
SARA Section 313:	Toxic Chemicals and Release Reporting
STEL:	Short Term Exposure Limit`
SVF:	Synthetic Vitreous Fiber
TDG:	Transportation of Dangerous Goods
TLV:	Threshold Limit Value (ACGIH)
TSCA:	Toxic Substances Control Act
TWA:	Time Weighted Average
WHMIS:	Workplace Hazardous Materials Information System (Canada)

Revision Summary: Updated corporate name. Added "wool" to CAS nomenclature. Replaces 05/19/05 MSDS.

MSDS Prepared By: UNIFRAX RISK MANAGEMENT DEPARTMENT

DISCLAIMER

The information presented herein is presented in good faith and believed to be accurate as of the effective date of this Material Safety Data Sheet. Employers may use this MSDS to supplement other information gathered by them in their efforts to assure the health and safety of their employees and the proper use of the product. This summary of the relevant data reflects professional judgment; employers should note that information perceived to be less relevant has not been included in this MSDS. Therefore, given the summary nature of this document, Unifrax I LLC does not extend any warranty (expressed or implied), assume any responsibility, or make any representation regarding the completeness of this information or its suitability for the purposes envisioned by the user.



Date: 9/6/2005
MSDS ID: 20509
Rev: 1.0.3
Replaces: 4/1/2003

Material Safety Data Sheet

Material Name: Fire Resistant Mineral Wool Insulation

Section 1— Chemical Product and Company Identification

Product Name(s): MinWool-1200™ Board, Flex, Blanket, Pipe, Sound Attenuation Fire Batts, Safing, Curtainwall, Pipe and Tank

Manufacturer Information
Industrial Insulation Group MinWool
908 John Bussey Drive
Phenix City, AL 36869
Web site: www.iig-llc.com

Trade Names: MinWool-1200

Phone number for Health and Safety Information: 970.858.6211 (M-F, 7am to 4 pm, Mountain Time)

Section 2 — Composition and Information on Ingredients

CAS #	Component	Percent	OSHA PEL	ACGIH TLV	NIOSH REL
65997-17-3	Synthetic Vitreous Fiber	95+	15(T) 5(R) mg/M ³	1f/cc	NE
25104-55-6	Cured Urea Formaldehyde/Phenol Binder	0-5	NE	NE	NE

ACGIH TLVs are 2003 values. OSHA PELs are those in effect on the date of preparation of this MSDS. The listed PELs, TLVs and RELs are time weighted average exposure limits.

Component Related Regulatory Information

This product may be regulated, have exposure limits or other information identified as the following:

Nuisance Particulates, Rock Wool Fibers

Section 3 — Hazards Identification

Emergency Overview:

Appearance and Odor: Commercial Board, Batt, and Pipe insulation is solid, green/yellow.

This product is an article and under normal conditions of use, this product is not expected to create any unusual emergency hazards. However, cutting, sawing, or abrading may increase the risk of personnel exposure.

Inhalation of excessive amounts of dust created when fabricating, cutting, or other mechanical alterations of the product may cause temporary upper respiratory irritation and/or congestion— remove affected individuals to fresh air.

Skin irritation may be treated by gently washing affected area with soap and warm water.

Eye irritation may be treated by flushing eyes with large amounts of water. If irritation persists, contact a physician.

Prolonged contact with dust from this product may cause Dermatitis.

Acrid smoke may be generated in a fire, use normal fire fighting procedures to prevent inhalation of smoke and gases.

HMIS Rating: Health: 0, Fire: 0, Reactivity 0, Other: 0

NFPA Rating: Health: 0, Flammability: 0, Reactivity: 0

WHMIS Class: IIG MinWool-1200 products are not controlled products

Potential Health Effects

Summary

Breathing dust from this product may cause a scratchy throat, congestion, and slight coughing.

Getting dust or fibers on the skin, or in the eyes may cause itching, rash, or redness.

Breathing large amounts of dust or fibers from this product may lead to chronic health effects as discussed in Section 11 of this material safety data sheet.

Inhalation:

If inhaled, remove the affected person to fresh air. If irritation persists, seek medical attention.

Skin Contact:

Dusts and fibers from this product may cause temporary mechanical irritation to the skin.

Eye Contact:

Dusts and fibers from this product may cause temporary mechanical irritation to the eyes.

Ingestion:

This product is not intended to be ingested or eaten under normal conditions of use. If ingested, it may cause temporary irritation to the gastrointestinal (GI) tract, especially the stomach.

Target Organs

Upper respiratory passages, skin, and eyes.

Primary Routes of Entry (Exposure)

Inhalation (breathing dust), skin, and eye contact.

Medical Conditions Aggravated by Exposure:

Chronic respiratory or skin conditions may temporarily worsen from exposure to this product.

Section 4 — First Aid Measure

First Aid: Inhalation

Remove to fresh air. Drink water to clear throat, and blow nose to remove dust. If irritation persists, get medical attention.

First Aid: Skin

Wash gently with soap and warm water to remove dust. Use a wash cloth to help remove fibers. To avoid further irritation, do not rub or scratch affected areas. Rubbing or scratching may force fibers into the skin. If irritation persists get medical attention. Never use compressed air to remove fibers from the skin. Wash hands before eating or using the restroom.

First Aid: Ingestion

Product is not intended to be ingested or eaten. If this product is ingested, irritation of the gastrointestinal (GI) tract may occur, and should be treated symptomatically. Watch the person for several days to make sure that partial or complete intestinal obstruction does not occur. Do not induce vomiting unless directed to do so by medical personnel. Rinse mouth with water to remove fibers, and drink plenty of water to help reduce the irritation. No chronic effects are expected following ingestion.

First Aid: Eyes

Do not rub or scratch your eyes. Fibers may cause the eye to be scratched. Flush eyes with large amounts of water for at least 15 minutes. If irritation persists, contact a medical professional.

First Aid: Notes to Physician

This product is a mechanical irritant, and is not expected to produce any chronic health effects from acute exposures. Treatment should be directed toward removing the source of irritation with symptomatic treatment as necessary.

Section 5 — Fire Fighting Measures

Flash Point: Not applicable
Upper Flammable Limit (UFL): Not applicable
Auto Ignition: Not determined
Rate of Burning: Not applicable

Method Used: Not applicable
Lower Flammable Limit (LFL): Not applicable
Flammability Classification: Non combustible

General Fire Hazard

There is no potential for fire or explosion.

Extinguishing Media

Use any extinguishing media appropriate for the surrounding fires

Fire Fighting Equipment/Instructions

No special procedures are expected to be necessary for this product. Normal fire fighting procedures should be followed to avoid inhalation of smoke and gases produced by other materials.

Hazardous Combustion Products:

Primary combustion products are carbon monoxide, carbon dioxide, ammonia, and water. Other undetermined compounds could be released in small quantities.

Section 6 — Accidental Release Measures

Containment Procedures

Pick up large pieces. Vacuum dusts. If sweeping is necessary, use a dust suppressant such as water. Do not dry sweep dust accumulation or use compressed air for clean-up. These procedures will help to minimize potential exposures. This material will sink and disperse along the bottom of waterways and ponds. It can not easily be removed after it is waterborne; however, the material is non-hazardous in water.

Clean-Up Procedures

Wastes are not hazardous as defined by the RCRA (40 CFR 261). Comply with state and local regulations for disposal of these products. If you are unsure of the regulations, contact your local Public Health Department, or the local office of the EPA.

Section 7 — Handling and Storage

Handling Procedures

Use protective equipment as described in Section 8 of this material safety data sheet when handling uncontained material. Keep product in its packaging, as long as practicable to minimize potential dust generation. Keep work areas clean. Avoid unnecessary handling of scrap materials by placing them in waste disposal containers and equipment, kept as to close working areas as possible, to prevent release of fibers and dust. Good housekeeping practices should be used to prevent generation and accumulation of dusts. After handling product, wash face and hands before eating, drinking, or smoking.

Storage Procedures

Warehouse storage should be in accordance with package directions, if any. Material should be kept dry, and protected from the elements.

Section 8 — Exposure Control and Personal Protection

General Product Information

Follow all applicable exposure limits and use OSHA-recommended equipment and work practices. A complete copy of these practices can be obtained from IIG MinWool LLC (see Section 1 of this Material Safety Data Sheet), and is also available on the OSHA website (<http://www.osha.gov/SLTC/syntheticmineralfibers>).

Personal Protective Equipment

Personal Protective Equipment: Eyes/Face

Safety glasses with side shields are recommended to keep dust out of the eyes.

Personal Protective Equipment: Skin

Leather or cotton gloves should be worn to prevent skin contact and irritation. Barrier creams may also be used to reduce skin contact and irritation caused by mineral wool fibers. Normal work clothing (long sleeved shirts and long pants) is recommended. Skin irritation is known to occur chiefly at the pressure points such as around the neck, wrists, waist and between the fingers.

Personal Protective Equipment: Respiratory

A respirator should be used if ventilation is unavailable, or is inadequate for keeping dust and fiber levels below the applicable exposure limits. In those cases, use a NIOSH-certified disposable or reusable particulate respirator with an efficiency rating of N95 or higher (under 42 CFR 84) when working with this product. For exposures up to five times the established exposure limits use a quarter-mask respirator, rated N95 or higher; and for exposures up to ten times the established exposure limits use a half-mask respirator (e.g., MSA's DM-11, Racal's Delta N95, 3M's 8210), rated N95 or higher.

Operations such as sawing, blowing, tear out, and spraying may generate airborne fiber concentrations requiring a higher level of respiratory protection. For exposures up to 50 times the established exposure limits use a full-face respirator, rated N99 or higher.

Ventilation

In fixed manufacturing settings, local exhaust ventilation should be provided at areas of cutting to remove

airborne dust and fibers. General dilution ventilation should be provided as necessary to keep airborne dust and fibers below the applicable exposure limits and guidelines. The need for ventilation systems should be evaluated by a professional industrial hygienist, while the design of specific ventilation systems should be conducted by a professional engineer.

Personal Protective Equipment: General

Loose-fitting, long-sleeved clothing should be worn to protect the skin from irritation. Exposed skin areas should be washed with soap and warm water after handling.

Section 9 — Physical & Chemical Properties

Appearance: Fibrous semi-circle, blanket, or board insulation.

Odor:	Organic	pH:	Not applicable
Physical State:	Solid	Vapor Density:	Not applicable
Vapor Pressure:	Not applicable	Melting Point:	Not determined
Boiling Point:	Not applicable	Specific Gravity:	Not determined
Solubility (H2O):	Nil	Freezing Point:	Not applicable
Viscosity:	Not applicable	Evaporation Rate:	Not applicable
VOC:	Not applicable	Percent Volatile:	0

Section 10 — Chemical Stability & Reactivity Information

Chemical Stability

This is a stable material. This product is not reactive.

Hazardous Decomposition

None.

Hazardous Polymerization

Will not occur.

Incompatible Materials:

This product reacts with hydrofluoric acid.

Hazardous Decomposition Products:

Primary combustion products are carbon monoxide, carbon dioxide, ammonia, and water. Other undetermined compounds could be released in small quantities.

Section 11 — Toxicological Information

Acute Toxicity

A: General Product Information

Dusts may cause mechanical irritation to eyes and skin. Ingestion may cause transient irritation of throat, stomach and gastrointestinal tract. Inhalation may cause coughing, nose and throat irritation, and sneezing. Higher exposures may cause difficulty breathing, congestion, and chest tightness.

B: Component Analysis - LD50/LC50

No LD50/LC50's are available for this product.

Carcinogenicity

A: General Product Information

OSHA, NTP, IARC, and ACGIH have not classified this product in its entirety as a carcinogen.

B: Component Analysis - LD50/LC50

Cured Urea/formaldehyde/phenol binder (25104-55-6)

Oral LD50 Rat : 7 gm/kg

Oral LD50 Mouse : 7 gm/kg

Carcinogenicity:

A: General Product Information

In October 2001 the IARC concluded its re-evaluation of the carcinogenic risk of mineral wool fibers. The result was a reclassification of the fibers from Group 2B (possibly carcinogenic to humans) to Group 3 (not classifiable as to the carcinogenicity to humans). Epidemiological studies published during the 15 years prior to the 2001 IARC review provide no evidence of increased risk of cancer from occupational exposure during manufacture or use of mineral wool fiber.

B: Component Carcinogenicity

ACGIH, IARC, OSHA, and NTP carcinogen lists have been checked for those components with CAS registry numbers.

Synthetic Vitreous Fiber (65997-17-3)

ACGIH: A3 - animal carcinogen (related to rock wool fibers) with unknown relevance to humans

IARC: Monograph 43, 1988 (related to Glass filaments) (Group 3 (not classifiable))

Section 12 — Ecological Information

Ecotoxicity

A: General Product Information

No data available for this product.

B: Component Analysis - Ecotoxicity - Aquatic Toxicity

No ecotoxicity data are available for this product's components.

Section 13 — Disposal Considerations

US EPA Waste Number & Descriptions

A: General Product Information

This product, as supplied, is not regulated as a hazardous waste by the U.S. EPA under RCRA regulations. Comply with state and local regulations for disposal. If you are unsure of the regulations, contact your local Public Health Department, or the local office of the EPA.

B: Component Waste Numbers

No EPA Waste Numbers are applicable for this product's components.

Disposal Instructions

Dispose of waste material according to Local, State, Federal, and Provincial Environmental Regulations.

Section 14 — Transport Information

US DOT Information

Shipping Name: This product is not classified a hazardous material for transport.

Section 15 — Regulatory Information

US Federal Regulations

A: General Product Information

No information on this product as a whole. Formaldehyde content is below the SARA 313 0.1% 'de minimis' concentration.

B: Component Analysis

This material contains one or more of the following chemicals required to be identified under SARA Section 302 (40 CFR 355 Appendix A), SARA Section 313 (40 CFR 372.65) and/or CERCLA (40 CFR 302.4).

Synthetic Vitreous Fiber(65997-17-3)

CERCLA: Includes mineral fiber emissions from facilities manufacturing or processing glass rock or slag fibers (or other mineral derived fibers) of average diameter 1 micrometer or less; Statutory RQ = 1 pound (.454 kg); no final RQ is being assigned to the generic or broad class (related to Fine mineral fibers)

State Regulations

A: General Product Information

The following statement(s) are provided under the California Safe Drinking Water and Toxic Enforcement Act of 1986 (Proposition 65): **WARNING!** This product contains a chemical known to the state of California to cause cancer.

Other Regulatory Information

A: General Product Information

No information available for the product.

B: TSCA Status

All ingredients of this product are included in the US EPA Chemical Substance Inventory or are not required to be listed.

C: CERCLA

Includes mineral fiber emissions from facilities manufacturing or processing glass rock or slag fibers (or other mineral derived fibers) of average diameter 1 micrometer or less; Statutory RQ = 1 pound (.454 kg); no final RQ is being assigned to the generic or broad class (related to Fine mineral fibers).

D: Clean Air Act

Mineral wool fiber appears on the Clean Air Act-1990 Hazardous Air Pollutants List.

International Regulations

A: General Product Information

Canada Workplace Hazardous Materials Information System (WHMIS)

WHMIS Classification: D2B– Irritant

Product classified as a manufactured article as defined in Hazardous Product Act (HPA), Section 11(1). Section 12(l) exempts it from the WHMIS supplier label and MSDS requirements of the Act.

B: Component Analysis - WHMIS IDL

No components are listed in the WHMIS IDL.

Section 16 — Other Information

Information about “Health and Safety Research on Rock- and Slag-wool” can be obtained from the North American Insulation Manufacturers Association (NAIMA), 44 Canal Center Plaza, Suite 310, Alexandria, VA 22314, or on the web at <http://www.naima.org>

This product has been classified according to the hazard criteria of the CPR and the MSDS contains all the information required by the CPR.

Key/Legend:

EPA = Environmental Protection Agency; TSCA = Toxic Substance Control Act; ACGIH = American Conference of Governmental Industrial Hygienists; IARC = International Agency for Research on Cancer; NIOSH = National Institute for Occupational Safety and Health; NTP = National Toxicology Program; OSHA = Occupational Safety and Health Administration; NFPA = National Fire Protection Association; HMIS = Hazardous Material Identification System; RCRA = Resource Conservation and Recovery Act; CERCLA = Comprehensive Environmental Response, Compensation and Liability Act; SARA = Superfund Amendments and Reauthorization Act; DSL = Canadian Domestic Substance List; EINECS = European Inventory of New and Existing Chemical Substances; WHMIS = Workplace Hazardous Materials Information System; CAA = Clean Air Act; CHPA=Canadian Hazardous Product Act; IDL=Canadian Hazardous Disclosure List

Revision Summary:

This is a revised MSDS which replaces Revision 1.0.2 with new formatting and updated exposure information. A new ID number was assigned to this document to be consistent with other IIG documents.

Get this and other MSDS forms electronically via Internet: <http://www.iig-llc.com>.

As of the date of preparation of this document, the foregoing information is believed to be accurate and is provided in good faith to comply with applicable federal and state law(s). However, no warranty or representation with respect to such information is intended or given.

IMPORTANT SAFETY NOTICE: The information in this MSDS relates only to the specific material described herein and does not relate to use in combination with any other material or substance or in any process. Because of the use of this information and the conditions of use of this product are not within the control of Industrial Insulation Group, it is the users obligation to determine the conditions of safe use of this product. Users of this product should study this MSDS and become aware of the product hazards and safety information before using this product. Users should also notify their employees, agents, and contractors regarding information contained in this MSDS and any product hazards and safety information in order to provide for safe use of this product.

Material Safety Data Sheet

SILICA, AS, CAS, AS/AR, CAS/AR, ASM and AST SERIES

1. CHEMICAL PRODUCT AND COMPANY IDENTIFICATION

Trade Names/Synonyms	Amorphous silica in various forms - cloth, tapes, blankets, mat, tubing, etc.
Product Identification	AS, CAS, AS/AR, CAS/AR, ASM and AST series.
Chemical Name/Synonyms	Continuous filament silicon dioxide (SiO ₂)/fibrous silica, amorphous silica chemical family.
Manufacturer's Name	DAR Industrial Products Inc 2 Union Hill Road Bldg # 1 West Conshohocken, Pa. 19428 (610) 825-4900
Date prepared	February 17, 1994
Revised	November 7, 1996 (second revision) November 4, 1997 (third revision: update Section 7, Handling based on IARC reclassification)
Reviewed for content & accuracy	April 16, 2007

2. COMPOSITION / INFORMATION ON INGREDIENTS

<u>Hazardous Ingredients</u>	<u>Weight %</u>	<u>OSHA-PEL</u>	<u>ACGIH-TLV</u>	<u>OTHER</u>
Silicone dioxide, continuous filament	≥ 90	a.	10 mg/ m ³ . 8-hr TWA	none known

Nonhazardous Ingredients

Sizing/bound water	≤ 10	-----none established-----		
--------------------	------	----------------------------	--	--

a. OSHA has not established a specific PEL for fibrous silicone dioxide (amorphous silica). It is considered to be a "particulate not otherwise regulated" (PNOR) and is covered under the OSHA nuisance dust PEL's of 5 mg/m³ for the respirable dust fraction and 15 mg/m³ for the total dust fraction for an 8-hr TWA (Time Weighted Average). Chemically, AMI-SIL[®] is amorphous silica which has an OSHA limit of 20 mg/m³.

3. HAZARDS IDENTIFICATION

PRIMARY ROUTES OF EXPOSURE: Inhalation and skin contact.

HEALTH HAZARDS (Including acute and chronic effects and symptoms of overexposure):

Material Safety Data Sheet

SILICA, AS, CAS, AS/AR, CAS/AR, ASM and AST SERIES

3. HAZARDS IDENTIFICATION (CONT)

- ACUTE:**
- Inhalation: Inhalation of dusts and fibers may result in irritation of the upper respiratory tract (mouth, nose and throat).
 - Skin Contact: Skin contact with dusts and fibers may produce itching and temporary mechanical irritation.
 - Eye Contact: Eye contact with fibers and dusts may produce temporary mechanical irritation.
 - Ingestion: Temporary mechanical irritation of the digestive tract. Observe individual. If symptoms develop, consult a physician.
- CHRONIC:** See carcinogenicity section below. There are no known health effects associated with chronic exposure to this product.

CARCINOGENICITY:

Hazardous Ingredients:	Listed as carcinogen by:	<u>ACGIH</u>	<u>IARC</u>	<u>NTP</u>	<u>OSHA</u>
Silicone dioxide, continuous filament		NA	NA	NA	NA

MEDICAL CONDITIONS AGGRAVATED BY EXPOSURE: Persons with a history of chronic respiratory or skin conditions that are aggravated by mechanical irritants may be at increased risk for worsening their condition from exposure during use of the product.

4. FIRST AID MEASURES

- Inhalation: Move individual to fresh air. Seek medical attention if irritation persists.
- Skin Contact: Wash with mild soap and running water. Use a washcloth to help remove fibers. To avoid further irritation do not rub or scratch irritated areas. Rubbing or scratching may force fibers into the skin. Seek medical attention if irritation persists.
- Eye Contact: Flush eyes with flowing water for at least 15 minutes. Seek medical attention if irritation persists.
- Ingestion: N. A. (Not Applicable)

Material Safety Data Sheet

SILICA, AS, CAS, AS/AR, CAS/AR, ASM and AST SERIES

5. FIRE FIGHTING MEASURES

Flash Point (°F): NA (Not Applicable)

Auto Ignition Temperature (°F): NA

Flammability Limits (%): LEL: NA UEL: NA

Extinguishing Media: Water, foam, carbon dioxide, dry chemical

Special Fire-Fighting Instructions: In a sustained fire, self contained breathing apparatus should be worn.

Unusual Fire and Explosion Hazards: None known.

6. ACCIDENTAL RELEASE MEASURES

ACTION TO TAKE FOR SPILLS (Use Appropriate Safety Equipment): For solid product, not applicable. For dusts and fibers generated during fabrication vacuum up and containerize.

7. HANDLING, STORAGE AND DISPOSAL

HANDLING: See Section 8.

The toxicologic data indicate that these materials should be handled with caution. The handling practices described in Section 8 of this MSDS must be strictly followed.

Product which has been in service at elevated temperature (> 1800° F) may undergo partial conversion to cristobalite, a form of crystalline silica. This reaction occurs at the lining hot face. As a consequence, this material becomes more friable (brittle); special caution must be taken to minimize generation of airborne dust. The amount of cristobalite present will depend on the temperature and length in service.

IARC has recently reviewed the animal, human and other relevant experimental data on silica in order to critically evaluate and classify the cancer causing potential. Based on its review, IARC has now classified crystalline silica/cristobalite as a Group 1 carcinogen. Crystalline silica inhaled in the form of quartz or cristobalite from industrial sources was classified as *carcinogenic to humans* on the basis of a relatively large number of epidemiological studies that together provided *sufficient evidence* in humans for the carcinogenicity of inhaled crystalline silica under the conditions specified. Crystalline silica is also listed by the NTP as a substance reasonably anticipated to be a carcinogen.

Material Safety Data Sheet

SILICA, AS, CAS, AS/AR, CAS/AR, ASM and AST SERIES

7. HANDLING, STORAGE AND DISPOSAL (CONT)

HANDLING (CONT): See Section 8.

Therefore, special care should be taken when working with "used" material to minimize the generation of dust. The OSHA permissible exposure limit (PEL) for cristobalite is 0.05 mg/m^3 (resp.). The ACGIH threshold limit value (TLV) for cristobalite is 0.05 mg/m^3 (resp.). (ACGIH 1989 - 90). If exposure limits are exceeded or if irritation is experienced, NIOSH approved respiratory protection should be worn. NIOSH approved respirator for particulates with a TLV of less than 0.05 mg/m^3 is generally acceptable, except that supplied air respirators are required for high airborne dust concentrations.

STORAGE: Store in a clean, dry area. Keep containers closed.

DISPOSAL: Dispose in accordance with federal, state and local regulations as a solid nonhazardous waste.

8. EXPOSURE CONTROLS / PERSONAL PROTECTION

VENTILATION: General dilution ventilation and/or local exhaust ventilation should be provided, as necessary, to maintain exposures below PEL's or TLV's. Adequate ventilation must be provided at elevated temperatures. The basic silica material is noncombustible; however, at temperatures above 250°F , the coating may generate light steam and/or smoke for a brief period which may require local ventilation some and/or exhaust.

RESPIRATORY PROTECTION: A properly fitted NIOSH/MHSA approved disposable dust respirator such as the 3M model 8710 or model 9900 (in high humidity environments) or equivalent should be used when: high dust levels are encountered; the level of fibers in the air exceeds the OSHA permissible exposure limits; or if irritation occurs. Use respiratory protection in accordance with your company's respiratory protection program and OSHA regulations under 29 CFR 1910.134.

EYE PROTECTION: Wear safety glasses or chemical goggles to prevent eye contact. Contact lenses should not be worn unless chemical goggles are also used and care is taken not to touch the eyes with contaminated body parts or materials. Have eye washing facilities readily available where eye contact can occur.

PROTECTIVE CLOTHING: Wear loose fitting, long sleeved shirt that covers to the base of the neck, and long pants. Skin irritation from exposure to silica fibers is known to occur chiefly at pressure points such as around the neck, wrist and waist. Wear gloves when handling product.

Material Safety Data Sheet

SILICA, AS, CAS, AS/AR, CAS/AR, ASM and AST SERIES

8. EXPOSURE CONTROLS / PERSONAL PROTECTION (CONT)

WORK/HYGIENIC PRACTICES: Handle in accordance with good industrial hygiene and safety practices:

- Avoid unnecessary exposure to dusts and fibers
- Remove fibers from skin after exposure
- Be careful not to rub or scratch irritated areas. Rubbing or scratching may force the fibers into the skin. The fibers should be washed off. Use of barrier creams can, in some instances, be helpful.
- Use vacuum equipment to remove fibers and dusts from clothing. **COMPRESSED AIR SHOULD NEVER BE USED.** Always wash work clothes separately and wipe out the washer/sink in order to prevent loose fibers from getting on other clothes.
- Keep the work area clean of any dusts and fibers generated during fabrication. Use vacuum equipment to clean up dusts and fibers. Avoid sweeping or using compressed air as these techniques resuspend dusts and fibers into the air.
- = Have access to safety showers and eye wash fountains.
- = For professional use only. **Keep out of children's reach.**

9. PHYSICAL AND CHEMICAL PROPERTIES

MELTING POINT (Softening): >3000°F

BOILING POINT (°C): NA (Not Applicable)

SPECIFIC GRAVITY: 2.2

PERCENT VOLATILE: NA

VAPOR PRESSURE (mm Hg): NA

VAPOR DENSITY (Air = 1): NA

EVAPORATIVE RATE (Ethyl Ether = 1): NA

SOLUBILITY IN WATER: Not soluble

APPEARANCE AND ODOR: White/off-white/tan colored solid with no odor; AR series has an orange color.

pH: NA

Material Safety Data Sheet

SILICA, AS, CAS, AS/AR, CAS/AR, ASM and AST SERIES

10. STABILITY AND REACTIVITY

STABILITY (Conditions to Avoid): Product is stable.

INCOMPATIBILITY (Materials to Avoid): Basic phosphates, hydrofluoric acid, some oxides and hydroxides.

HAZARDOUS DECOMPOSITION PRODUCTS: Sizings or binders may decompose in a fire. Primary decomposition products include carbon monoxide, carbon dioxide, other hydrocarbons and water.

HAZARDOUS POLYMERIZATION: Will not occur.

To the best of our knowledge, the information contained herein is accurate. The information provided is based upon data furnished by our suppliers. However, neither DAR Industrial Products Inc. nor any of its subsidiaries assumes any liability whatsoever for the accuracy or completeness of the information contained herein. While believed to be reliable, the information or products are intended for use by skilled persons at their own risk. Final determination of suitability of any material is the sole responsibility of the user. All materials may present unknown hazards and should be used with caution. Although certain hazards are described herein, we cannot guarantee that these are the only hazards which exist.

Material Safety Data Sheet

WIRE MESH, IWM Series1. CHEMICAL PRODUCT AND COMPANY IDENTIFICATION

Trade Names/Synonyms	Inconel Mesh Cable
Product Identification	Inconel Mesh Cable
Chemical Name/Synonyms	Inconel alloy.
Manufacturer's Name	D.A.R. Industrial Products Inc. 2 Union Hill Road, Bldg # 1 West Conshohocken, Pa. 19428
Date prepared	October 19, 1998
Reviewed for accuracy & content	<u>April 2, 2007</u>

2. COMPOSITION / INFORMATION ON INGREDIENTS

<u>Hazardous Ingredients</u>	<u>Weight %</u>	<u>OSHA-PEL</u>	<u>ACGIH-TLV</u>	<u>OTHER</u>
Iron (Fe) (as oxide fume)	proprietary	10 mg/m ³	5 mg/m ³	-----
Chromium (Cr)	proprietary	1 mg/m ³	0.5 mg/m ³	-----
Nickel (Ni)	proprietary	1 mg/m ³	1 mg/m ³	-----
Cobalt (Co)	proprietary	0.1 mg/m ³	0.1 mg/m ³	-----
Aluminum (Al)	proprietary	none	10 mg/m ³	-----
Manganese (Mn) Dust	proprietary	5 mg/m ³ C*	5 mg/m ³ C*	-----
Fume		3 mg/m ³	-----	-----
Molybdenum (Mo)	proprietary	15 mg/m ³	10 mg/m ³	-----
Tantalum (Ta)	proprietary	5 mg/m ³	5 mg/m ³	-----
Tungsten (W)	proprietary	none	5 mg/m ³	-----
Yttrium (Y)	proprietary	1 mg/m ³	1 mg/m ³	-----
<u>Nonhazardous Ingredients</u>	<u>Weight %</u>	<u>OSHA-PEL</u>	<u>ACGIH-TLV</u>	<u>OTHER</u>
Niobium (Nb)	proprietary	-----	none	-----
Iron (Fe) Dust	proprietary	-----	none	-----

C* = Ceiling Limit

Material Safety Data Sheet

AMI-FAB® WIRE MESH, IWM Series

3. HAZARDS IDENTIFICATION

PRIMARY ROUTES OF EXPOSURE: Inhalation and skin contact of dusts and fumes.

HEALTH HAZARDS (Including acute and chronic effects and symptoms of overexposure):

ACUTE: NOTE: Inconel products in their usual physical state do not pose any health hazards. However, when subjected to welding, burning, grinding, cutting, abrasive blasting, heat treatment, pickling, or similar operations, potentially hazardous fumes or dusts may be emitted. Despite the fact that welding, burning, etc. of inconel products in this category may produce fumes containing manganese, chromium, nickel and copper, the air concentrations generated of these components are expected to be extremely low.

Iron (Fe): Subjecting iron and alloys containing iron to high temperatures (such as welding) will cause the formation of iron oxide. Long-term exposure to iron oxide fumes or dusts has been associated with a benign lung condition known as siderosis which is observable as an x-ray change. No physical impairment of lung function has been linked to siderosis.

Manganese (Mn): Mn intoxication is usually due to the oxide or salts of Mn; elemental Mn exhibits very low toxicity. The dusts and fumes can act as minor irritants to the eyes and respiratory tract. Both acute and chronic exposure may adversely affect the central nervous system (CNS), but symptoms are more likely to occur after at least one or two years of prolonged or repeated exposures. Early symptoms may include weakness in the lower extremities, sleepiness, salivation, nervousness and apathy. In more advanced stages, severe muscular incoordination, impaired speech, spastic walking, mask-like facial expressions and uncontrollable coughing may occur. Manganese fumes have also been reported to result in metal fume fever, a flu-like syndrome with symptoms such as dizziness, chills, fever, headache and nausea. An increased incidence of pneumonia, bronchitis and pneumonitis has been reported in some worker populations exposed to manganese. Animal studies indicate exposure may increase susceptibility to bacterial and viral infection.

Chromium (Cr): The toxicity and health hazards of chromium are heavily dependent on its oxidation state. The elemental (as in the metals), divalent and trivalent forms are of very low toxicity. The hexavalent form (such as occurs in chromates and chromic acids) is very toxic and can produce both acute and chronic effects. Adverse effects on the skin may include ulcerations, irritative dermatitis and allergic skin reactions. Adverse effects on the respiratory system may include bronchospasms, edema, hypersecretion, bronchitis, irritation, allergic asthmatic reactions, and, ulceration and perforation of the nasal septum. Respiratory symptoms may include coughing and wheezing, shortness of breath and nasal itch. Eye irritation or inflammation can also be produced. Exposure to some hexavalent chromium compounds have also been shown to be associated with an increased risk of lung cancer.

Nickel (Ni): Ni fumes and dust are respiratory irritants and may cause severe pneumonitis. Skin contact with nickel and its compounds may cause an allergic dermatitis. The resulting skin rash is often referred to as "nickel itch". Ni and its compounds may also produce eye irritation, particularly on the inner surfaces of the eyelids (i.e. the conjunctiva). Animal and/or epidemiology studies have linked nickel and certain nickel compounds to an increased incidence of cancer of the lungs and nasal passages.

Material Safety Data Sheet

AMI-FAB® WIRE MESH, IWM Series

3. HAZARDS IDENTIFICATION (CONT'D)

Copper (Cu): Inhalation of copper fume may cause irritation of the eyes and throat and a flu-like illness called metal fume fever. Signs and symptoms of metal fume fever include fever, muscle aches, nausea, chills, dry throat, cough and weakness. Cu fume may also produce a metallic or sweet taste. Repeated or prolonged exposure to Cu fume may cause discoloration of the skin or hair.

Aluminum (Al): There are no reported known health effects. Aluminum is generally considered to be in the nuisance dust category.

Silicon (Si): Silicon may produce x-ray changes in the lungs. There has been no known disability reported from the x-ray changes.

Tungsten (W): There has been some reported evidence of pulmonary involvement such as a cough.

Molybdenum (Mo): Molybdenum has caused, in animal studies, irritation of the nose and throat, weight loss and digestive disturbances. There have been no reports of industrial poisoning.

Cobalt (Co): Cobalt has been reported to cause asthma. It may also cause interstitial pneumonitis and sensitization of the respiratory system.

ACUTE: Inhalation: Inhalation of dusts and fibers may result in irritation of the upper respiratory tract (mouth, nose and throat).

Inconel - dust or fumes may give a metallic taste; headache; nausea; chills; fever; tightness of chest; irritation of the respiratory tract, eyes, nose; cough.

Loss of consciousness/death due to welding gases or lack of oxygen.

Skin Contact: Skin contact with dusts and fibers may produce itching and temporary mechanical irritation.

Eye Contact: Eye contact with fibers and dusts may produce temporary mechanical irritation.

Ingestion: Temporary mechanical irritation of the digestive tract. Observe individual. If symptoms develop, consult a physician.

CHRONIC: See carcinogenicity section below. Chronic exposure to Chromium (Cr)/Nickel (Ni)/Manganese (Mn) fumes or dust may cause skin sensitization, asthma, bronchitis, lung fibrosis or pneumoniosis. It may also cause damage to the kidneys and liver as well as the nervous system.

Material Safety Data Sheet

AMI-FAB® WIRE MESH, IWM Series

3. HAZARDS IDENTIFICATION (CONT'D)

CARCINOGENICITY:

Hazardous Ingredients: Listed as carcinogen by: ACGIH IARC NTP OSHA

Chromium (Cr)/Nickel (Ni)** ----none known----

****Dusts and fumes containing Chromium (Cr) or Nickel (Ni) should be considered carcinogens.**

MEDICAL CONDITIONS AGGRAVATED BY EXPOSURE: Persons with a history of chronic respiratory or skin conditions that are aggravated by mechanical irritants may be at increased risk for worsening their condition from exposure during use of the product.

4. FIRST AID MEASURES

Inhalation: Move individual to fresh air. Seek medical attention if irritation persists. Administer artificial respiration, if breathing has stopped.

Skin Contact: Wash with mild soap and running water. To avoid further irritation do not rub or scratch irritated areas. Seek medical attention if irritation persists.

Eye Contact: Flush eyes with flowing water for at least 15 minutes. Seek medical attention if irritation persists.

Ingestion: N. A. (Not Applicable)

5. FIRE FIGHTING MEASURES

Flash Point (°F): NA (Not Applicable)

Auto Ignition Temperature (°F): NA

Flammability Limits (%): LEL: NA UEL: NA

Extinguishing Media: Water, foam, carbon dioxide, dry chemical

Special Fire-Fighting Instructions: In a sustained fire, self contained breathing apparatus should be worn.

Unusual Fire and Explosion Hazards: None known.

6. ACCIDENTAL RELEASE MEASURES

ACTION TO TAKE FOR SPILLS (Use Appropriate Safety Equipment): For solid product, not applicable. For dusts and fibers generated during fabrication vacuum up and containerize.

Material Safety Data Sheet

AMI-FAB® WIRE MESH, IWM Series

7. HANDLING, STORAGE AND DISPOSAL

HANDLING: See Section 8.

STORAGE: No special precautions necessary.

DISPOSAL: Dispose in accordance with federal, state and local regulations as a solid nonhazardous waste.

8. EXPOSURE CONTROLS / PERSONAL PROTECTION

VENTILATION: General dilution ventilation and/or local exhaust ventilation should be provided, as necessary, to maintain exposures below PEL's or TLV's. **Adequate ventilation must be provided at elevated temperatures. Adequate ventilation must also be provided when welding or grinding the inconel core.**

RESPIRATORY PROTECTION: A properly fitted NIOSH/MHSA approved disposable dust respirator should be used when: high dust levels are encountered; the level of Chromium/Nickel/Manganese/Cobalt/Aluminum/Molybdenum/Tantalum/Tungsten/Yttrium dust in the air exceeds the OSHA permissible exposure limits; or if irritation occurs. Use an air supplied respirator in confined spaces. Use industrial hygiene air monitoring to insure that TLV or PEL values are not exceeded. Use respiratory protection in accordance with your company's respiratory protection program and OSHA regulations under 29 CFR 1910.134 .

EYE PROTECTION: Safety glasses, goggles or face shields should be worn.

PROTECTIVE CLOTHING: Wear loose fitting, long sleeved shirt that covers to the base of the neck, and long pants. Wear gloves when handling product.

WORK/HYGIENIC PRACTICES: Handle in accordance with good industrial hygiene and safety practices:

- = Avoid unnecessary exposure to dusts.
- = **Do not expose skin when cutting, grinding or welding the inconel mesh cable.**
- = Be careful not to rub or scratch irritated areas. Use of barrier creams can, in some instances, be helpful.
- = Use vacuum equipment to remove dusts from clothing. **COMPRESSED AIR SHOULD NEVER BE USED.** Always wash work clothes separately.
- = Keep the work area clean of any dusts generated during fabrication. Use vacuum equipment to clean up dusts. Avoid sweeping or using compressed air as these techniques resuspend dusts into the air.
- = Have access to safety showers and eye wash fountains.
- = For professional use only. **Keep out of children's reach.**

Material Safety Data Sheet

AMI-FAB® WIRE MESH, IWM Series

9. PHYSICAL AND CHEMICAL PROPERTIES

MELTING POINT (Softening): NM (Not Measured)

BOILING POINT (°C): NA (Not Applicable)

SPECIFIC GRAVITY (Bare Glass): NM

PERCENT VOLATILE: NA

VAPOR PRESSURE (mm Hg): NA

VAPOR DENSITY (Air = 1): NA

EVAPORATIVE RATE (Ethyl Ether = 1): NA SOLUBILITY IN WATER: Not soluble

APPEARANCE AND ODOR: Metallic appearing mesh with no odor.

pH: NA

10. STABILITY AND REACTIVITY

STABILITY (Conditions to Avoid): Product is stable.

INCOMPATIBILITY (Materials to Avoid): None known.

HAZARDOUS DECOMPOSITION PRODUCTS: SEE SECTION 3.

HAZARDOUS POLYMERIZATION: Will not occur.

To the best of our knowledge, the information contained herein is accurate. The information provided is based upon data furnished by our suppliers. However, neither [redacted], nor any of its subsidiaries assumes any liability whatsoever for the accuracy or completeness of the information contained herein. While believed to be reliable, the information or products are intended for use by skilled persons at their own risk. Final determination of suitability of any material is the sole responsibility of the user. All materials may present unknown hazards and should be used with caution. Although certain hazards are described herein, we cannot guarantee that these are the only hazards which exist.



Date: 8/31/2005
 MSDS ID: 20501
 Rev: 1.0.4
 Replaces: 10/6/2003

Material Safety Data Sheet

Material Name: Calcium Silicate Insulation

Section 1— Chemical Product and Company Identification

Product Name: Thermo-12[®] Gold Calcium Silicate Insulation
CAS# Mixture/None Assigned
Generic Name: Insulation (Calcium Silicate)
Formula: Mixture
Chemical Name: Synthetic Calcium Silicate

Manufacturer Information

Industrial Insulation Group
 2100 Line Street
 Brunswick, GA. 31520

Phone number for Health and Safety Information: 970.858.6211 (M-F, 7:00a.m. to 4:00p.m., Mountain Time)

Trade Name: Thermo-12 Gold

Section 2 — Composition and Information on Ingredients

CAS #	Component	Percent	OSHA	ACGIH	NIOSH	UNITS
			PEL	TLV	REL	
1344-95-2	Synthetic Calcium Silicate	> 93	15(T) 5(R)	10	10(T) 5(R)	mg/M ³
51274-00-1	Iron-based color	< 1	15(T) 5(R)	10	NE	mg/M ³
65997-17-3	Synthetic Vitreous Fiber	0 - 2	15(T) 5(R)	5	5	mg/M ³
9004-34-6	Cellulose Fiber	0 - 2	15(T) 5(R)	10	10(T) 5(R)	mg/M ³
1344-09-8	Sodium Silicate	0 - 6	15(T) 5(R)	10	NE	mg/M ³

NE = Not Established

ACGIH TLVs are 2003 values. OSHA PELs are those in effect on the date of preparation of this MSDS. The listed PELs, TLVs and RELs are time weighted average exposure limits.

Component Related Regulatory Information

This product may be regulated, have exposure limits or other information identified as the following:
 Nuisance particulates.

Section 3 — Hazards Identification

Emergency Overview

APPEARANCE AND ODOR: Odorless, Yellow semi-circle or block insulation with coloring throughout as a visual marker to indicate this is an asbestos-free product.

This product is an article and under normal conditions of use, this product is not expected to create any unusual emergency hazards. However, cutting, sawing, or abrading may increase the risk of personnel exposure.

Inhalation of excessive amounts of dust created when fabricating, cutting, or other mechanical alterations of the product may cause temporary upper respiratory irritation and/or congestion— remove affected individuals to fresh air.

Skin irritation may be treated by gently washing affected area with soap and warm water.

Eye irritation may be treated by flushing eyes with large amounts of water. If irritation persists, contact a physician.

Prolonged contact with dust from this product may cause Dermatitis.

In the event of fire, use normal fire fighting procedures to prevent inhalation of smoke and gases.

HMIS Rating: Health: 1, Fire: 0, Reactivity 0, Other: 0
WHMIS Class: Thermo-12 Gold is not a WHMIS controlled product

Potential Health Effects

Summary

Breathing dust from this product may cause a scratchy throat, congestion, and slight coughing.

Getting dust or fibers on the skin, or in the eyes may cause itching, rash, or redness.

Breathing large amounts of dust or fibers from this product may lead to chronic health effects as discussed in Section 11 of this material safety data sheet.

Inhalation

Irritation of the upper respiratory tract (scratchy throat), coughing, and congestion may occur in extreme exposures.

Skin

Temporary irritation (itching) or redness may occur.

Absorption

Not applicable

Ingestion

This product is not intended to be ingested or eaten under normal conditions of use. If ingested, it may cause temporary irritation to the gastrointestinal (GI) tract, especially the stomach.

Eyes

Temporary irritation (itching) or redness may occur.

Target Organs

Upper respiratory passages, skin, and eyes.

Primary Routes of Entry (Exposure)

Inhalation (breathing dust), skin, and eye contact.

Medical Conditions Aggravated by Exposure

Pre-existing chronic respiratory, skin, or eye diseases or conditions may be aggravated by exposure to this product

Section 4 — First Aid Measures

First Aid: Inhalation

Remove to fresh air. Drink water to clear throat, and blow nose to remove dust.

First Aid: Skin

Wash gently with soap and warm water to remove dust. Wash hands before eating or using the restroom.

First Aid: Ingestion

Product is not intended to be ingested or eaten. If this product is ingested, irritation of the gastrointestinal (GI) tract may occur, and should be treated symptomatically. Rinse mouth with water to remove fibers, and drink plenty of water to help reduce the irritation. No chronic effects are expected following ingestion.

First Aid: Eyes

Do not rub or scratch your eyes. Dust particles may cause the eye to be scratched. Flush eyes with large amounts of water for 5-15 minutes. If irritation persists, contact a medical professional.

First Aid: Notes to Physician

This product is a mechanical irritant, and is not expected to produce any chronic health effects from acute exposures. Treatment should be directed toward removing the source of irritation with symptomatic treatment as necessary.

Section 5 — Fire Fighting Measures

Flash Point: Not applicable
Upper Flammable Limit (UFL): Not applicable
Auto Ignition: Not determined
Rate of Burning: Not applicable

Method Used: Not applicable
Lower Flammable Limit (LFL): Not applicable
Flammability Classification: Non combustible

General Fire Hazard

There is no potential for fire or explosion.

Extinguishing Media

Use any extinguishing media appropriate for the surrounding fires

Fire Fighting Equipment/Instructions

No special procedures are expected to be necessary for this product. Normal fire fighting procedures should be followed to avoid inhalation of smoke and gases produced by other materials.

Section 6 — Accidental Release Measures

Containment Procedures

Pick up large pieces. Vacuum dusts. If sweeping is necessary, use a dust suppressant such as water. Do not dry sweep dust accumulation or use compressed air for clean-up. These procedures will help to minimize potential exposures.

Clean-Up Procedures

Wastes are not hazardous as defined by the RCRA (40 CFR 261). Comply with state and local regulations for disposal of these products. If you are unsure of the regulations, contact your local Public Health Department, or the local office of the Environmental Protection Agency (EPA).

Section 7 — Handling and Storage

Handling Procedures

Use protective equipment as described in Section 8 of this material safety data sheet when handling uncontained material. Good housekeeping practices should be used to prevent generation and accumulation of dusts. After handling product, wash face and hands before eating, drinking, or smoking.

Storage Procedures

Warehouse storage should be in accordance with package directions, if any. Material should be kept dry, and protected from the elements.

Section 8 — Exposure Control and Personal Protection

General Product Information

This product may contain trace amounts of crystalline silica as a natural contaminant in the raw materials. However, standard industrial hygiene air monitoring surveys conducted under normal and test (worst-case) situations have not detected any airborne respirable crystalline silica in the occupational environment.

Personal Protective Equipment

Personal Protective Equipment: Eyes/Face

Safety glasses with side shields are recommended to keep product out of the eyes.

Personal Protective Equipment: Skin

Leather or cotton gloves should be worn to prevent skin contact and irritation. Barrier creams may also be used to reduce skin contact and irritation caused by fiber glass.

Personal Protective Equipment: Respiratory

A respirator should be used if ventilation is unavailable, or is inadequate for keeping dust and fiber levels below the applicable exposure limits. In those cases, use a NIOSH-certified disposable or reusable particulate respirator with an efficiency rating of N95 or higher (under 42 CFR 84) when working with this product. For exposures up to five times the established exposure limits use a quarter-mask respirator, rated N95 or higher; and for exposures up to ten times the established exposure limits use a half-mask respirator (e.g., MSA's DM-11, Racal's Delta N95, 3M's 8210), rated N95 or higher.

Operations such as sawing, blowing, tear out, and spraying may generate airborne fiber concentrations requiring a higher level of respiratory protection. For exposures up to 50 times the established exposure limits use a full-face respirator, rated N99 or higher.

Ventilation

In fixed manufacturing settings, local exhaust ventilation should be provided at areas of cutting to remove airborne dust and fibers. General dilution ventilation should be provided as necessary to keep airborne dust and fibers below the applicable exposure limits and guidelines. The need for ventilation systems should be evaluated by a professional industrial hygienist, while the design of specific ventilation systems should be conducted by a professional engineer.

Personal Protective Equipment: General

Loose-fitting, long-sleeved clothing should be worn to protect the skin from irritation. Exposed skin areas should be washed with soap and warm water after handling.

Section 9 — Physical & Chemical Properties

Appearance: Semi-circle or block insulation with yellow coloring throughout as a visual marker to indicate this is an asbestos free product.

Odor:	Odorless	pH:	Not applicable
Physical State:	Solid	Vapor Density:	Not applicable
Vapor Pressure:	Not applicable	Melting Point:	1200-1500°C
Boiling Point:	Not applicable	Specific Gravity:	0.24-0.27
Solubility (H2O):	Nil	Freezing Point:	Not applicable
Viscosity:	Not applicable	Evaporation Rate:	Not applicable
VOC:	Not applicable	Percent Volatile:	0

Section 10 — Chemical Stability & Reactivity Information

Chemical Stability

This is a stable material. This product is not reactive.

Hazardous Decomposition

None.

Hazardous Polymerization

Will not occur.

Section 11 — Toxicological Information

Acute Toxicity

A: General Product Information

The primary acute health effects of this product include mechanical irritation of the skin and eyes and skin dryness as a result of contact with dust, amorphous silica, and fibers.

B: Component Analysis - LD50/LC50

No LD50/LC50's are available for this product or its components.

Carcinogenicity

A: General Product Information

OSHA, NTP, IARC, and ACGIH have not classified this product in its entirety as a carcinogen.

B: Component Carcinogenicity

Calcium silicate (1344-95-2)

ACGIH: A4 - Not Classifiable as a Human Carcinogen

Synthetic Vitreous Fiber (65997-17-3)

ACGIH: A4 - Not Classifiable as a Human Carcinogen (related to rock wool fiber)

IARC: Monograph 43, 1988 (related to Glass filaments) (Group 3 (not classifiable))

Section 12 — Ecological Information

Ecotoxicity

A: General Product Information

No data available for this product.

B: Component Analysis - Ecotoxicity - Aquatic Toxicity

No ecotoxicity data are available for this product's components.

Section 13 — Disposal Considerations

US EPA Waste Number & Descriptions

A: General Product Information

This product, as supplied, is not regulated as a hazardous waste by the U.S. Environmental Protection Agency (EPA) under Resource Conservation and Recovery Act (RCRA) regulations. Comply with state and local regulations for disposal. If you are unsure of the regulations, contact your local Public Health Department, or the local office of the EPA.

B: Component Waste Numbers

No EPA Waste Numbers are applicable for this product's components.

Disposal Instructions

Dispose of waste material according to Local, State, Federal, and Provincial Environmental Regulations.

Section 14 — Transport Information

US DOT Information

Shipping Name: This product is not classified a hazardous material for transport.

Section 15 — Regulatory Information

US Federal Regulations

A: General Product Information

No information on this product as a whole.

B: Component Analysis

None of this product's components are listed under SARA Section 302 (40 CFR 355 Appendix A), SARA Section 313 (40 CFR 372.65), or CERCLA (40 CFR 302.4).

State Regulations

A: General Product Information

No information available for the product.

Other Regulatory Information

A: General Product Information

No information available for the product.

B: TSCA Status

No information available for the product.

International Regulations

Canada Workplace Hazardous Materials Information System (WHMIS)

WHMIS Classification: D2B– Irritant

Product classified as a manufactured article as defined in HPA, Section 11(1). Section 12(l) exempts it from the WHMIS supplier label and MSDS requirements of the Act.

Component Analysis - WHMIS IDL

The following components are identified under the CHPA IDL:

Sodium Silicate—CAS 1344-09-8

Section 16 — Other Information

This product has been classified according to the hazard criteria of the CPR and the MSDS contains all the information required by the CPR.

Key/Legend:

EPA = Environmental Protection Agency; TSCA = Toxic Substance Control Act; ACGIH = American Conference of Governmental Industrial Hygienists; IARC = International Agency for Research on Cancer; NIOSH = National Institute for Occupational Safety and Health; NTP = National Toxicology Program; OSHA = Occupational Safety and Health Administration; NFPA = National Fire Protection Association; HMIS = Hazardous Material Identification System; CERCLA = Comprehensive Environmental Response, Compensation and Liability Act; SARA = Superfund Amendments and Reauthorization Act; DSL = Canadian Domestic Substance List; EINECS = European Inventory of New and Existing Chemical Substances; WHMIS = Workplace Hazardous Materials Information System; CAA = Clean Air Act; CHPA=Canadian Hazardous Product Act; IDL=Canadian Hazardous Disclosure List

Revision Summary:

This is a revised MSDS which replaces Revision 1.0.3 with new formatting and clarified exposure limits. Get this and other MSDS forms electronically via Internet: <http://www.iig-llc.com> or by calling 1-970-858-6200.

As of the date of preparation of this document, the foregoing information is believed to be accurate and is provided in good faith to comply with applicable federal and state law(s). However, no warranty or representation with respect to such information is intended or given.

IMPORTANT SAFETY NOTICE: The information in this MSDS relates only to the specific material described herein and does not relate to use in combination with any other material or substance or in any process.

Because of the use of this information and the conditions of use of this product are not within the control of Industrial Insulation Group, it is the users obligation to determine the conditions of safe use of this product. Users of this product should study this MSDS and become aware of the product hazards and safety information before using this product. Users should also notify their employees, agents, and contractors regarding information contained in this MSDS and any product hazards and safety information in order to provide for safe use of this product.

LIBERTY-BELLE INSTRUCTION MANUAL

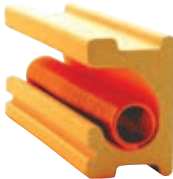

L&L Kiln's patented
hard ceramic
element holders
protect your kiln.



2019 CATALOG



KILNS

BUILT

TO

LAST

Clean. Precise. Dependable.

L&L Kiln's patented hard ceramic element holders protect your kiln.

- **Fires Clean**
- **Fires Evenly**
- **Easy to Program**
- **Keeps Working**



hotkilns.com/easy-fire



KILNS BUILT TO LAST



INDEX TO L&L KILNS

PROFESSIONAL POLYGONAL KILNS

Easy-Fire Flagship Kilns	4-5
School-Master School Kilns	6
Equad-Pro Production Kilns	7
Jupiter Configurable Sectional Kilns	8-9
Pull-Apart Kilns	10
JH Series Chrystalline Glaze Kilns.....	11

SMALL CRAFT KILNS

DL Series Doll & Test Kilns.....	12
Fuego Craft Kilns	13
Liberty-Belle Craft Kilns.....	14

SQUARE & RECTANGULAR KILNS

Easy-Fire XT Series Square Kilns	15
DaVinci Production Kilns	16-17

FRONT-LOADING KILNS

eFL Series Inexpensive Front-Loading Kilns.....	18-19
Hercules Medium Sized Commercial Front-Loader Kilns.....	20
Easy-Load Large Commercial Front-Loading Kilns.....	21

BELL-LIFT KILNS

DaVinci Large Bell Lift Kilns.....	22
Jumbo 100 Cubic Foot Production / Industrial Kilns	23

INDUSTRIAL KILNS

Car Bottom Kilns.....	24
Large Front-Loading Kilns	24
Large Polygonal Kilns	25
Large Square Kilns.....	25
Alloy Retort Kilns	25

OPTIONS

Vent-Sure Vent and Vent Options.....	26
Control, Power and Thermocouple Options	27
Element Options.....	28
Stand Options	28
Unpowered Sections.....	28
Powered Bottoms	28
Custom Options	28
Kiln Shelves and Posts	29

L&L FEATURES

Signature L&L Features.....	30-31
-----------------------------	-------

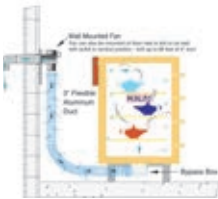
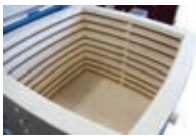

EASY-FIRE KILNS

L&L's Flagship Kilns

This is the classic L&L pottery kiln used by most of our customers. Now with a new angled control panel for easy viewing.



- DynaTrol Dynamic Three Zone Control
- 4 Easy-Fire plus 6 Custom Programs
- Hard Ceramic Element Holders
- Cone 10 • 2350°F • 1290°C (except for single phase e28T-3 models)
- Choice of 2-1/2" or 3" Brick
- Full-View Solid Peephole Plugs
- Stainless Spring Hinge - Wide Open for Easy Loading
- Full-Support Heavy-Duty 14 Gauge Aluminized Stand
- Fold Down Angled Panel for Easy Maintenance
- c-MET-us listed to UL499 Standards

Features & Benefits

CONSTRUCTION

Sectional: Made of 9" high sections with a reversible bottom and a spring-hinged top. The case is stainless steel wrapped around 2-1/2" or 3" of K23 highly insulating firebrick with 3 adjusting screw clamps per section. Easy to move: hotkilns.com/assemble-easy-fire



Brushed stainless steel spring hinge (on 23" & 28" diameter models) makes opening easy while still allowing lid to be supported and providing an unobstructed opening for easy loading. Safety pin prevents lid from closing while loading.



Firebrick is coated with a proprietary anti-dusting, hardening, and reflective coating.

Ceramic element terminals make element changes easy using a wrench.

A heavy 14 gauge full support solid stand with multiple bends for strength. Includes molded plastic feet protectors.

Full-view solid ceramic peephole plugs are 1" diameter non-tapered with heat-locked head. There is one for each section.

ELEMENT HOLDER SYSTEM

Patented hard ceramic element holders protect brick and elements from wear and loading damage. All-ceramic element connection block and hard holders makes changing elements easy.



DYNATROL ZONE CONTROL

DynaTrol with 4 Easy-Fire programs (Slow Bisque, Fast Bisque, Slow Glaze, Fast Glaze), 6 Vary-Fire custom programs, PreHeat, Delay, Program & Segment Review, and Diagnostics. Zone control with 2 or 3 zones. Separate Type K 8 gauge thermocouples with ceramic protection tubes. Genesis touch screen control optional (see page 27).

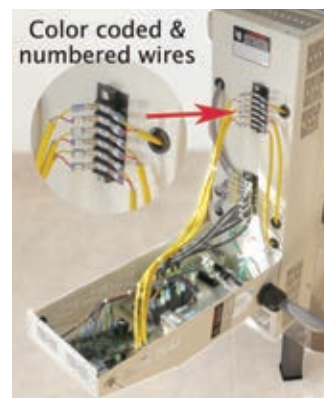

PIGGY-BACKED COOL-FIRE CONTROL PANEL

All controls and components are in a separate angled control panel that is piggy-backed on top of the element connection box. Both boxes are hinged and open and remove easily. A layer of insulation plus the separate control box keep the controls and relays cool. Power wires are oversized to run cool. On/off switch and control fuse included.

INSTRUCTIONS AND SUPPORT

Complete visual instructions with control reference, process information, assembly, troubleshooting, and parts list. Web videos show how to use the control. (hotkilns.com/videos)

Limited 3 year warranty. (hotkilns.com/warranty)

View all features of L&L Kilns at hotkilns.com/features

Options

FURNITURE KIT

Includes Cone 11 full shelves and half shelves as listed below plus a square post kit which includes six each 1/2", 1", 2", 4", 6" and 8" high 1-1/2" square cordierite posts plus heat-resistant gloves. Prices below.



VENT-SURE DOWNDRAFT KILN VENT (PAGE 26)

Vent-Sure 130 CFM downdraft vent pulls air down to bottom of kiln to improve temperature uniformity and vent corrosive fumes. Bypass collection box mounted on kiln allows adjustment of venting. Fan motor, mounted away from the kilns, stays cool and no vibration transmitted to the kiln. See page 26.

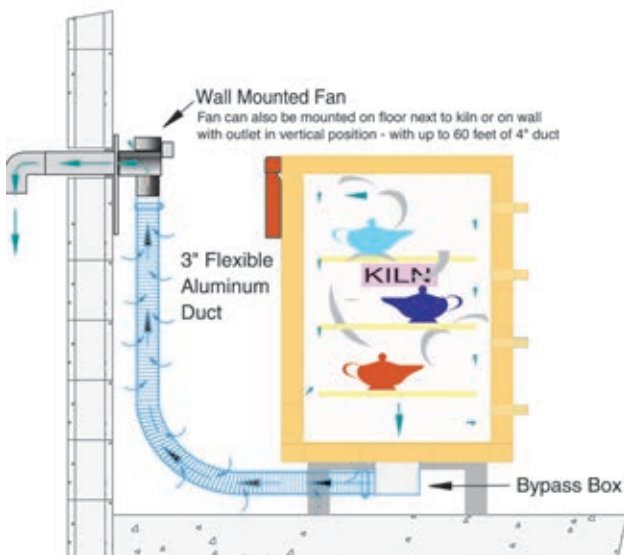

- Vent-Sure (120 volts) (M-V-VENT/00)\$520
- Vent Doubler (M-V-VENT/DB)\$155
- Vent Control (M-V-CNTL/00)\$160

VOLTAGE OPTIONS (PAGE 27)

Order 240 or 208 volts, single or three phase, or international voltages. KW, amperage, and fuse size for each voltage below. 480 volts is not available. No Charge for any voltage options.

ROLLING KILN STAND (PAGE 28)



L&L's rolling kiln stand features heavy gauge (14 ga) galvanized steel construction with multiple bends for extra strength, steel swivel locking casters, integrated vent collection box support, and guide rails for the kiln. Each size is fitted to the kiln. See page 28.

- Rolling Stand for 8 Sided Kiln (A-J-18RL/00)\$290
- Rolling Stand for 10 Sided Kiln (A-J-23RL/00).....\$345
- Rolling Stand for 12 Sided Kiln (A-J-28RL/00).....\$375

CONTROL OPTIONS (PAGE 27)

- Genesis Touch Screen Control (N-G-GENS/OP)\$135
- KISS Computer Software (N-G-KISS/US)\$700
- Door Interlock Switch (K-E-LATC/00)\$320
- Type S Platinum Thermocouples (T-G-SJUP/UG) \$250 each
- Pyrocil metallic Thermocouples (T-G-E23M/UG)\$44 each

ELEMENT OPTIONS (PAGE 28)



Quad Element Option: Four rows of elements for each 9" kiln section. Maximum element life for constant high-firing. See page 28. Prices below.

APM Elements. Priced by Quote.

SEE PAGES 26-29 FOR THESE AND MORE OPTIONS

Model No.	Kiln Price	Furn Kit	Quad Elem	No. Shelves F=full, H=half	Brick Thick	Inside Diam	Inside Height	Cubic Feet	Exterior Dimensions (in)	240/1 KW-Amp-Fuse	240/3 KW-Amp-Fuse	208/1 KW-Amp-Fuse	208/3 KW-Amp-Fuse	Lbs Kiln	Lbs w/Kit
e18S	\$2050	\$340	\$200	15.5" (1F, 4H)	2.5"	17.5"	18"	2.6	29W x 31H x 30D	5.7~23.9~30	5.7~20.7~30	5.0~23.9~30	5.0~20.8~30	190	245
e18S-3	\$2100	\$340	\$200	15" (1F, 4H)	3"	16.5"	18"	2.5	29W x 32H x 30D	5.7~23.9~30	5.7~20.7~30	5.0~23.9~30	5.0~20.8~30	220	255
e18T	\$2700	\$380	\$280	15.5" (2F, 4H)	2.5"	17.5"	27"	3.9	29W x 40H x 30D	8.4~35.0~50	8.4~20.2~30	8.4~40.4~60	8.4~23.3~30	230	305
e18T-3	\$2775	\$380	\$280	15" (2F, 4H)	3"	16.5"	27"	3.7	29W x 41H x 30D	8.4~35.0~50	8.4~20.2~30	8.4~40.4~60	8.4~23.3~30	255	325
e23S	\$2725	\$380	\$230	21" (1F, 4H)	2.5"	23.5"	18"	4.7	31W x 32H x 42D	9.5~39.4~50	9.5~34.1~50	8.3~40.0~50	8.3~34.6~50	265	350
e23S-3	\$2825	\$380	\$230	20" (1F, 4H)	3"	22.5"	18"	4.4	31W x 33H x 42D	9.5~39.4~50	9.5~34.1~50	8.3~40.0~50	8.3~34.6~50	305	375
e23T	\$3375	\$475	\$340	21" (2F, 4H)	2.5"	23.5"	27"	7.0	31W x 41H x 42D	11.5~48.0~60	11.5~27.7~40	10.0~48.0~60	11.0~30.5~40	325	420
e23T-3	\$3450	\$475	\$340	20" (2F, 4H)	3"	22.5"	27"	6.7	31W x 42H x 42D	11.5~48.0~60	11.5~27.7~40	10.0~48.0~60	11.0~30.5~40	360	455
e28S-3	\$3325	\$590	\$305	25-1/2" (6H)	3"	28"	18"	6.8	37W x 33H x 48D	11.5~47.9~60	11.5~41.5~60	10.0~48.0~60	10.0~41.6~60	370	470
e28T-3	\$3950	\$720	\$445	25-1/2" (8H)	3"	28"	27"	10.2	37W x 42H x 48D	11.5~48.0~60	16.6~40.0~50	10.0~48.0~60	14.3~39.8~50	460	565

Cone Rating: All models are rated to Cone 10 except the single phase e28T-3 which is rated to Cone 8 at 240V/1 Phase, Cone 5 at 208V/1 Phase, but Cone 10 for any 3 phase kiln. If planning continuous Cone 6 firings on a 10 cubic foot single phase kiln we recommend the eQuad-Pro eQ2827-3 (page 7) or the Jupiter JD2927-3 (page 8) (both have more KW than the e28T-3 in their single phase versions).

Plugs on US Models only: 6-50 on single phase and 15-50 on three phase.

UL Listing: c-MET-us listed to UL499 standards. **CE Listing:** CE Listed models are available.

More: See Easy-Fire Specification Sheets at hotkilns.com/spec-easy-fire for shipping dimensions, electrical ratings, fuse and wire sizes.

SCHOOL-MASTER

Made For Schools

For busy school teachers who want a simple control.

5-YEAR WARRANTY



Features & Benefits

SPECIAL FIVE-YEAR LIMITED WARRANTY

(hotkilns.com/five-year-warranty)

■ ONE-TOUCH™ INTUITIVE KILN CONTROL

The One-Touch™ Control is designed for busy school teachers - One touch and you are ready to fire the bisque and glaze programs typically used in schools. (It is also easy to adjust simple parameters like cone, delay, hold, heat-up and cool-down rates). You can even create four custom ramp/hold programs. hotkilns.com/one-touch



■ Cone 6 • 2230°F • 1220°C (except for 208 volt single phase SM28T-3 model)

■ Single zone with graded elements

■ Includes all other features of the Easy-Fire Kiln Series

Options

FURNITURE KIT

Includes Cone 11 full shelves and half shelves as listed below plus a square post kit which includes six each 1/2", 1", 2", 4", 6" and 8" high 1-1/2" square cordierite posts plus heat-resistant gloves. Prices below.

POWERFUL VENT-SURE DOWNDRAFT KILN VENT (PAGE 26)

Vent-Sure (120 volts) (M-V-VENT/00).\$520
 Vent Doubler (M-V-VENT/DB)\$155
 Vent Control (M-V-CNTL/00)\$160

VOLTAGE & CONTROL OPTIONS

Voltage: Order 240 or 208 volts, single or three phase, or international voltages. KW, amperage, and fuse size for each voltage below. 480 volts is not available. No Charge for any voltage options.

Door Interlock Switch (Page 27).....\$320

SEE PAGES 26-29 FOR THESE AND MORE OPTIONS

Vent options and rolling stand.

SCHOOL-MASTER KILNS ARE WARRANTED FOR FIVE YEARS!

School-Master Kilns are super-durable and include all of the easy-maintenance features of the Easy-Fire kilns. For simplicity, however, School-Master kilns feature the intuitive One-Touch™ kiln control that has a standard Bisque and Glaze program tuned to the needs of most K-12 programs. Temperature, heating and cooling rate, delay time and soak time can all be easily modified for the two main programs and remain set that way until deliberately changed. In addition, for more advanced users, there are four custom programs. The control is single zone and the kilns have graded elements. Because there are only two sizes the element resistance is well-tuned for good performance. The School-Master kilns are limited to Cone 6 operation even though the construction of the kilns can handle higher temperatures.

Model No.	Kiln Price	Furn Kit	No. of Shelves F=full, H=half	Brick Thick	Inside Diam	Inside Height	Cubic Feet	Exterior Dimensions	240/1 KW-Amp-Fuse	240/3 KW-Amp-Fuse	208/1 KW-Amp-Fuse	208/3 KW-Amp-Fuse	Lbs Kiln	Lbs w/Kit
SM23T	\$3275	\$475	21" (2F, 4H)	2.5"	23.5"	27"	7.0	31W x 41H x 42D	11.5~48.0~60	11.5~27.7~40	10.0~48.0~60	11.0~30.5~40	325	420
SM23T-3	\$3350	\$475	20" (2F, 4H)	3"	22.5"	27"	6.7	31W x 42H x 42D	11.5~48.0~60	11.5~27.7~40	10.0~48.0~60	11.0~30.5~40	360	455
SM28T-3	\$3850	\$720	25.5" (8H)	3"	28"	27"	10.2	37W x 42H x 48D	11.5~48.0~60	16.6~40.0~50	10.0~48.0~60	14.3~39.8~50	460	565

Cone Rating: All models rated for Cone 6 except for the single phase 208 volt SM28T-3, which is rated for Cone 5. If planning continuous Cone 6 firings on a 10 cubic foot single phase kiln we recommend the eQuad-Pro eQ2827-3 (page 7) or the Jupiter JD2927-3 (page 8) because they have more power. **Plugs on US Models only:** 6-50 on single phase and 15-50 on three phase. **UL Listing:** c-MET-us listed to UL499 standards. **CE Listing:** CE Listed models are available. **More:** See hotkilns.com/spec-school-master for shipping dimensions, electrical ratings, fuse and wire sizes.

eQUAD-PRO KILNS

Super-Duty High Production Kilns



The eQuad-Pro sets a new standard in production kilns.

Not UL499 listed

Features & Benefits

- Cone 10 • 2350°F • 1290°C - with extra power with branch fusing for high production and dense loads
- Quad element system (four rows of super heavy gauge elements per 9" high section)
- 3" K23 brick with proprietary reflective brick coating that protects brick and minimizes dusting
- DynaTrol with Dynamic Zone Control (3 Zones). Genesis Touch Screen Control is optional (see page 27).
- Piggy-back cool-fire control panel like Easy-Fire
- Hard ceramic element holders
- Type K 8 GA thermocouples with ceramic protection tubes
- Full support 14 gauge aluminized steel stand
- Solid peephole plugs with full 1" view
- "Easy-Lift, Easy-Load" stainless steel spring hinge system with full-support when door is up and tilted back (there are no support bars to get in the way of loading)
- Three-year Limited Warranty

Options

FURNITURE KIT

Cone 11 full shelves and half shelves as listed below plus a square post kit plus heat-resistant gloves. Prices below.

VENT-SURE DOWNDRAFT KILN VENT (PAGE 26)

Vent-Sure 130 CFM downdraft vent\$520

VOLTAGE & CONTROL OPTIONS (PAGE 27)

Voltage: Order 240 or 208 volts, single or three phase, or international voltages. KW, amperage, and fuse size for each voltage below. 480 volts is not available. No Charge for any voltage options.

Genesis Touch Screen Control (N-G-GENS/OP)\$135
 KISS Computer Software (N-G-KISS/US)\$700
 Type S Platinum Thermocouples (T-G-SJUP/UG) \$250 each
 Pyrocl metallic Thermocouples (T-G-E23M/UG)\$44 each

SEE PAGES 26-29 FOR THESE AND MORE OPTIONS

Genesis control, KISS software, vent options, rolling stand and more.

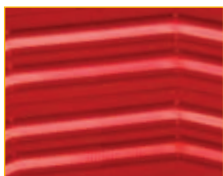

QUAD ELEMENT SYSTEM INCLUDED

This photograph shows the inside of an eQuad-Pro while firing. Notice how the element holders glow and disperse the radiant heat. The large diameter elements (both of the wire gauge and outside diameter of the element coil), coupled with the unique glowing feature of the hard dense ceramic element holders make these elements last for a very long time. (hotkilns.com/quad) **Optional APM Elements:** Priced by Quote.

Model No.	Kiln Price	Furn Kit	No. of Shelves F=full, H=half	Inside Diam	Inside Height	Cubic Feet	Exterior Dimensions	240/1 KW-Amp-Fuse	240/3 KW-Amp-Fuse	208/1 KW-Amp-Fuse	208/3 KW-Amp-Fuse	Lbs Kiln	Lbs w/Kit
eQ2327-3	\$4275	\$475	20" (2F, 4H)	22.5"	27"	6.7	31W x 42H x 42D	13.4~56.0~70	13.4~32.4~50	11.7~56.0~70	11.7~32.4~50	365	485
eQ2827-3	\$4950	\$720	25.5" (8H)	28"	27"	10.2	37W x 42H x 48D	15.0~62.3~80	15.0~36.0~50	15.0~71.9~90	15.0~41.5~60	480	585
eQ2836-3	\$5800	\$855	25.5" (10H)	28"	36"	13.6	37W x 51H x 48D	19.0~79.2~100	19.0~51.5~70	19.0~91.3~125*	19.0~60.4~80	595	725

*Note: Special model eQ2836-X-208-1P is available with 16.6 KW, 208 Volt/1 Phase, 80 amps for a 100 amp fuse.

More: See hotkilns.com/spec-equad-pro for additional information like shipping dimensions, electrical ratings, fuse sizes and wire connection sizes. All models are direct wired with no cords. For controls see hotkilns.com/dynatrol and hotkilns.com/zone.

Listings: These kilns are not yet UL499 Listed.

JUPITER KILNS

Easy To Take Apart & Highly Customizable

Jupiter kilns are easy-to stack and disassemble because of the plug-in sections.



- Sections can be added later or removed for smaller loads
- DynaTrol with Dynamic Zone Control (2 zones in 18" high models, 3 zone in all other models)
- Hard Ceramic Element Holders
- Most Models are Cone 10 • 2350°F • 1290°C (See grid)
- Choice of 2-1/2" or 3" Brick
- Full-View Solid Peephole Plugs
- Stainless "Easy-Lift, Easy-Load" Spring Hinge
- Wide Open Easy Loading
- Heavy-Duty 14 Gauge Aluminized Stand
- Removable Panel for Easy Maintenance
- c-MET-us listed to UL499 Standards

Features and Benefits

CONSTRUCTION

Sectional: Made of 9" high sections with a reversible bottom and a spring-hinged top (23" & 28" models). The case is stainless steel wrapped around 2-1/2" or 3" of K23 highly insulating firebrick with 3 adjusting screw clamps per section.



Brushed stainless steel spring hinge (on 23" & 28" diameter models) makes opening easy while still allowing lid to be supported while providing an unobstructed opening for easy loading. Safety pin prevents lid from closing while loading.

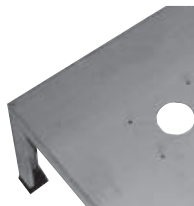

Firebrick is coated with a proprietary anti-dusting, hardening, and reflective coating.

Ceramic element terminals make element changes easy using a wrench.

A heavy 14 gauge full support solid stand with multiple bends for strength. Includes molded plastic feet protectors.

Full-view solid ceramic peephole plugs are 1" diameter non-tapered with heat-locked head. There is one for each section.

ELEMENT HOLDER SYSTEM

Patented hard ceramic element holders protect brick and elements from wear and loading damage. All-ceramic element connection block and hard holders makes changing elements easy.

DYNAMIC ZONE CONTROL

DynaTrol with 4 Easy-Fire programs (Slow Bisque, Fast Bisque, Slow Glaze, Fast Glaze), 6 Vary-Fire custom programs, PreHeat, Delay, Program & Segment Review, and Diagnostics. Zone control with 2 or 3 zones. Separate Type K 8 gauge thermocouples with ceramic protection tubes. Genesis touch screen control optional (see page 27).



SEPARATE PLUG-IN CONTROL PANEL

The Jupiter control panel is separate from the kiln. Keeps controls and relays cool. All sections plug into it. Hinged and removable for easy maintenance. On/off switch and control fuse included.

INSTRUCTIONS AND SUPPORT

Complete visual instructions with control reference, process information, assembly, troubleshooting, and parts list. Web videos show how to use the control. (hotkilns.com/videos)

Limited 3 year warranty. (hotkilns.com/warranty)

You can view all features of L&L Kilns at hotkilns.com/features

Options

FURNITURE KIT

Includes Cone 11 full shelves and half shelves as listed below plus a post kit which includes six each 1/2", 1", 2", 4", 6" and 8" high 1-1/2" square cordierite posts plus heat-resistant gloves. Prices below.



VENT-SURE DOWNDRAFT KILN VENT (PAGE 26)

Vent-Sure 130 CFM downdraft vent pulls air down to bottom of kiln to improve temperature uniformity and vent corrosive fumes. Bypass collection box mounted on kiln allows adjustment of venting. Fan motor, mounted away from the kilns, stays cool and no vibration transmitted to the kiln. See page 26.

Vent-Sure (120 volts) (M-V-VENT/00)\$520
 Vent Doubler (M-V-VENT/DB)\$155
 Vent Control (M-V-CNTL/00)\$160

VOLTAGE OPTIONS (PAGE 27)

240 or 208 volts, single or three phase, or international voltages. KW, amperage, and fuse size for each voltage below. No Charge except for 480 volts.

480 volts/3 phase (available only on JD2900 Series)\$750
 NEMA 1 Panel (required for MET-us Listing)\$750

SEE PAGES 26-29 FOR THESE AND MORE OPTIONS

Genesis control, KISS software, High Limit Control, Back up contactors, vent options, rolling stand and more.

ROLLING KILN STAND (PAGE 28)



L&L's rolling kiln stand features heavy gauge (14 ga) galvanized steel construction with multiple bends for extra strength, steel swivel locking casters, integrated vent collection box support, and guide rails for the kiln. Each size is fitted to the kiln. See page 28.

Rolling Stand for 8 Sided Kiln (A-J-18RL/00)\$290
 Rolling Stand for 10 Sided Kiln (A-J-23RL/00).....\$345
 Rolling Stand for 12 Sided Kiln (A-J-28RL/00).....\$375

CONTROL OPTIONS (PAGE 27)

Genesis Touch Screen Control (N-G-GENS/OP)\$135
 KISS Computer Software (N-G-KISS/US)\$700
 Type S Platinum Thermocouples (T-G-SJUP/UG)\$250 each
 Pyroclil metallic Thermocouples (T-G-E23M/UG)\$44 each
 High Limit Back Up Control (N-G-PKHL/00)\$640
 Back up Contactors Two-Section Kilns (N-G-BCJ2/00)\$170
 Back up Contactors Three-Section Kilns (N-G-BCJ3/00).....\$225
 Back up Contactors Four-Section Kilns (N-G-BCJ4/00).....\$280
 Back up Contactors Five-Section Kilns (N-G-BCJ5/00)\$340

ELEMENT OPTIONS (PAGE 28)



Quad Element Option: Four rows of elements for each 9" kiln section. Maximum element life for constant high-firing. See page 28. Prices below.

APM Elements. Priced by Quote.

Model No.	Kiln Price	Powered Bottom	Furn Kit	Quad Elem	No. of Shelves F=full, H=half	Inside Diam	Inside Height	Cubic Feet	Cone Rating	240/1 KW-Amp-Fuse	240/3 KW-Amp-Fuse	208/1 KW-Amp-Fuse	208/3 KW-Amp-Fuse	Lbs Kiln	L b s w/Kit
-----------	------------	----------------	----------	-----------	-------------------------------	-------------	---------------	------------	-------------	-------------------	-------------------	-------------------	-------------------	----------	-------------

JD JUPITER KILNS WITH 2.5" BRICK

JD18	\$2050	n/a	\$340	\$200	15.5" (1F, 4H)	17.5"	18"	2.6	10	5.5~23.0~30	5.5~19.9~30	5.5~26.5~30	5.5~23.0~30	200	245
JD18X	\$2850	n/a	\$380	\$280	15.5" (2F, 4H)	17.5"	27"	3.9	10	8.3~34.5~50	8.3~19.9~30	8.3~39.8~50	8.3~23.0~30	245	295
JD23V	\$2725	\$525	\$380	\$225	21" (1F, 4H)	23.5"	18"	4.7	5	7.0~29.3~40	7.0~25.4~40	6.1~29.3~40	6.1~25.4~40	275	350
JD230V	\$3375	\$525	\$475	\$340	21" (2F, 4H)	23.5"	27"	7.0	10	10.6~44.0~60	10.6~25.4~40	9.1~44.0~60	9.1~25.4~40	330	425
JD236V	\$4050	\$525	\$545	\$440	21" (3F, 4H)	23.5"	36"	9.4	10	14.1~58.6~80	14.1~38.1~50	12.2~58.6~80	12.2~38.1~50	360	455
JD245V	\$4750	\$525	\$635	\$555	21" (4F, 4H)	23.5"	45"	11.8	10	17.6~73.3~100	17.6~50.8~70	15.2~73.3~100	15.2~50.8~70	445	560

JD JUPITER KILNS WITH 3" BRICK

JD18-3	\$2125	n/a	\$340	\$200	15" (1F, 4H)	16.5"	18"	2.5	10	5.5~23.0~30	5.5~19.9~30	5.5~26.5~30	5.5~23.0~30	230	280
JD18X-3	\$2975	n/a	\$380	\$280	15" (2F, 4H)	16.5"	27"	3.7	10	8.3~34.5~50	8.3~19.9~30	8.3~39.8~50	8.3~23.0~30	270	320
JD23V-3	\$2850	\$525	\$380	\$225	20" (1F, 4H)	22.5"	18"	4.5	5	7.0~29.3~40	7.0~25.4~40	6.1~29.3~40	6.1~25.4~40	315	340
JD230V-3	\$3525	\$525	\$475	\$340	20" (2F, 4H)	22.5"	27"	6.7	10	10.6~44.0~60	10.6~25.4~40	9.1~44.0~60	9.1~25.4~40	385	470
JD236V-3	\$4250	\$525	\$545	\$440	20" (3F, 4H)	22.5"	36"	8.9	10	14.1~58.6~80	14.1~38.1~50	12.2~58.6~80	12.2~38.1~50	460	545
JD245V-3	\$5000	\$525	\$635	\$555	20" (4F, 4H)	22.5"	45"	11.1	10	17.6~73.3~100	17.6~50.8~70	15.2~73.3~100	15.2~50.8~70	540	650
JD2918-3	\$3950	\$675	\$590	\$280	25.5" (6H)	28"	18"	6.8	5	9.1~38.0~50	9.1~32.9~50	8.3~40.0~50	8.3~34.6~50	380	480
JD2927-3	\$4925	\$675	\$720	\$390	25.5" (8H)	28"	27"	10.2	10	13.7~57.0~80	13.7~32.9~50	12.5~60.0~80	12.5~34.6~50	450	575
JD2936-3	\$6275	\$675	\$855	\$530	25.5" (10H)	28"	36"	13.6	10	18.2~76.0~100	18.2~49.3~70	16.6~80.0~100	16.6~52.0~70	565	715
JD2945-3	\$7425	\$675	\$985	\$640	25.5" (12H)	28"	45"	17.0	10	22.8~95.0~125	22.8~65.8~90	20.8~100.0~125	20.8~69.3~90	645	820

Note About EZ Models: All the J2300 series are available with higher watts "EZ" elements (the same elements used in the e23T kilns) at no extra charge. See web and specification sheet for details.

Cone Rating: See above chart. **More:** See various Jupiter Automatic specification sheets at hotkilns.com/spec-jupiter-auto for additional information like shipping dimensions, electrical ratings, fuse sizes and wire connection sizes. **Power Hookup:** Plugs on kilns that have less than 48 amps, otherwise direct wired. For controls see hotkilns.com/dynatrol and hotkilns.com/zone.

PULL APART KILNS

For Sculpture and Large Structural
Ceramics



PULL-APART OPTION FOR SCULPTURE

Any Jupiter or DaVinci kiln can be made with the Pull-Apart Option.

Includes floor mount stand for control panel, lift off lid with extra handles but no hinge.

This option allows the entire kiln to be dismantled to make it easy to load large sculptural pieces. The kiln sections are unplugged and then taken off one at a time.

There is no charge for this option. However, If you want the "Easy-Lift, Easy-Load" spring hinge on the Jupiter Series there is a \$235 extra charge.

More at hotkilns.com/pull-apart-kilns



An example of a super large special DaVinci Pull-Apart kiln that is 42" square by 85" high

JH SERIES

Crystalline Glaze Kilns

This is the "Thoroughbred" of kilns. Designed specifically for Crystalline Glaze firing - high, fast, responsive and precise.



Not
UL499
Listed

Features & Benefits

- Designed specifically for firing crystalline glaze with fast heat up, fast cool down to freeze crystals and the ability to soak without prematurely aging elements
- Cone 12 • 2400°F • 1315°C
- Includes 2-1/2" of K25 2500°F firebrick on sides and bottom with a 3" thick top
- Approximately 25% more power than base models
- Quad element holder system with super heavy-duty elements
- Type S platinum thermocouples included as standard
- DynaTrol with Dynamic Zone Control. (Optional Genesis touch screen control. See page 27).
- Includes other features that are standard on the base models
- Three-year Limited Warranty

Options

FURNITURE KIT

Cone 11 full shelves and half shelves as listed below plus a square post kit plus heat-resistant gloves. Prices below.

VENT-SURE DOWNDRAFT KILN VENT (PAGE 26)

Vent-Sure (120 volts) (M-V-VENT/00)\$520
 Vent Doubler (M-V-VENT/DB)\$155
 Vent Control (M-V-CNTL/00)\$160

VOLTAGE, CONTROL AND ELEMENT OPTIONS (PAGE 27)

Voltage: Order 240 or 208 volts, single or three phase, or international voltages. KW, amperage, and fuse size for each voltage below. 480 volts is not available. No Charge for any voltage options.

Genesis Touch Screen Control (N-G-GENS/OP)\$135
 KISS Computer Software (N-G-KISS/US)\$700
 SSR Power Controls Priced by Quote
 APM ElementsPrices below

SEE PAGES 26-29 FOR THESE AND MORE OPTIONS

A SPECIAL KILN DESIGNED JUST FOR CRYSTALLINE GLAZE FIRING

The JH kilns feature special higher temperature K25 firebrick for extra high cone 12 firing (and faster cool-down), extra power for fast heat up, "Quad" element configuration for extra element area, super heavy-duty thick elements to hold up to the special rigors of crystalline firing, minimal insulation to allow for fast cool down, and type S thermocouples for long life. Custom variations on the basic design such as more insulation, APM elements, more power and special sizes are available by special quote.

Note that the JD2927-JH uses a floor standing large DaVinci control panel and also includes a lid brace because of the 2.5" brick insulation.

Model No.	Kiln Price	APM Elements	Furn Kit	No. of Shelves F=full, H=half	Inside Diam	Inside Height	Cubic Feet	240/1 KW-Amp-Fuse	240/3 KW-Amp-Fuse	208/1 KW-Amp-Fuse	208/3 KW-Amp-Fuse	Lbs Kiln	Lbs w/Kit
JD18-JH	\$3050	\$665	\$340	15.5" (1F, 4H)	17.5"	18"	2.6	8.8~36.7~60	8.8~31.7~50	8.8~42.3~60	8.8~36.8~50	255	300
e23S-JH	\$3550	\$785	\$380	21" full (1F, 4H)	23.5"	18"	4.7	10.5~47.9~60	10.5~41.5~50	10.0~48.0~60	10.0~41.6~50	280	365
JD230-JH	\$5625	\$1175	\$475	21" full (2F, 4H)	23.5"	27"	7.0	13.7~57.0~80	13.7~32.9~50	12.5~60.0~80	12.5~34.7~50	400	505
JD2927-JH	\$7175	\$1225	\$720	25.5" (8H)	29"	27"	10.3	18.0~75.2~100	18.0~43.5~60	18.0~86.7~125	18.0~50.1~70	580	710

More: See hotkilns.com/spec-jh for additional information like shipping dimensions, electrical ratings, fuse sizes and wire connection sizes. For controls see hotkilns.com/dynatrol and hotkilns.com/zone. Plugs vary with model, voltage and phase. See Specification sheet.

Listings: These kilns are not yet UL499 Listed

DL SERIES

11"D x 9"H
Test Kilns



Not
UL499
Listed

Features & Benefits

The DL Series is a small test kiln available in 120, 208 or 240 volts and with either a One-Touch or DynaTrol program control. It has the full range of premium L&L features such as hard ceramic element holders, Type K 8 gauge thermocouple with ceramic protection tube, full support 14 gauge aluminized steel stand, solid peephole plug with full 1" view, proprietary reflective brick coating that protects brick and minimizes dusting, and three-year limited warranty. Now features 3" Top & bottom.

Specifications

Temperature: (See below)

Cubic Feet: 0.5

Inside Diameter: 11" **Inside Height:** 9"

Outside Dimensions: 19" W x 25" D x 22" H

More: See hotkilns.com/spec-doll for additional information like shipping dimensions, electrical ratings, fuse sizes and wire connection sizes.

NOTE: The 240 or 208 volt versions are highly recommended for high fire applications.

Options

Furniture Kit: Includes two 9" diameter full shelves and four each of 1/2", 1", 1-1/2", 2", 2-1/2", 3" and 4" triangular posts.

Controls: Choice of DynaTrol, Genesis touch screen control, or One-Touch Control (see below for prices and see opposite page for description of the controls).

Quad Element System (watts & amps do not change - there are four rows of elements with Quad system). Prices below.

Model No.	Kiln Price	Furn Kit	Quad Elements	Temperature Control	Cone Rating	Watts	Amps	Volts	Fuse	Plug	Lbs Kiln	Lbs w/Kit
DL11-DB	\$1250	\$135	\$130	One-Touch	5	1800	15	120	20	5-15	110	130
DLH11-DB	\$1250	\$135	\$130	One-Touch	6	2160	18	120	25	5-20	110	130
DL11-D	\$1400	\$135	\$130	DynaTrol	5	1800	15	120	20	5-15	110	130
DLH11-D	\$1400	\$135	\$130	DynaTrol	6	2160	18	120	25	5-20	110	130
DLH11-DXB-240	\$1250	\$135	\$130	One-Touch	10	2800	11.7	240	15	14-30	110	130
DLH11-DXB-208	\$1250	\$135	\$130	One-Touch	10	2800	13.5	208	20	14-30	110	130
DLH11-DX-240	\$1400	\$135	\$130	DynaTrol	10	2800	11.7	240	15	14-30	110	130
DLH11-DX-208	\$1400	\$135	\$130	DynaTrol	10	2800	13.5	208	20	14-30	110	130

Listings: These kilns are not yet UL499 Listed.

FUEGO

13.5"D x 18"H
20 Amp
Cone 10
Craft Kilns



Not
 UL499
 Listed

Features & Benefits

The Fuego kiln has been used for years internationally and is now offered in the USA with even more power for faster heat up and longer element life.

The Fuego Craft Kiln reaches Cone 10 with power to spare. This ideally sized home craft kiln uses a minimal 240 volt 20 amp circuit. Includes simple One-Touch program control (or optional DynaTrol). Great for apartments or houses with smaller power systems.

L&L Premium Features: hard ceramic element holders, Type K 8 gauge thermocouple with ceramic protection tube (single zone), full support 14 gauge aluminized steel stand, two solid peephole plugs with full 1" view, proprietary reflective brick coating that protects brick and minimizes dusting, and three-year limited warranty.

Special Features: Brick thickness is 3" and also includes a layer of non-RCF fiber between the stainless steel case and firebrick for extra insulation, a door shut-off switch for the elements, and an extra peephole plug in the top for manual venting.

Specifications

Temperature: 2350°F, Cone 10

Cubic Feet: 1.5

Inside Diameter: 13.5" **Inside Height:** 18"

Outside Dimensions: 22" W x 27" D x 31" H

Options

Furniture Kit: Includes three 12" diameter full shelves and four each of 1", 2", 4" and 6" triangular posts.

240, 220 or 208 single phase are all standard options. 3 phase not available. No Charge for any voltage options.

Quad Element System (watts & amps do not change - elements doubled & more massive with Quad system). Prices below.

Controls: Choice of DynaTrol, Genesis touch screen control, or One-Touch Control.



ONE-TOUCH CONTROL

One touch and you are ready to fire your bisque and glaze programs (It is easy to adjust simple parameters like cone, delay, hold, heat-up and

cool-down rates). You can even create four custom ramp/hold programs. hotkilns.com/one-touch

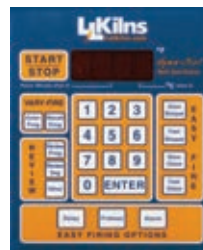

DYNATROL ZONE CONTROL

DynaTrol with 4 Easy-Fire programs (Slow Bisque, Fast Bisque, Slow Glaze, Fast Glaze), 6 Vary-Fire custom programs, PreHeat, Delay, Program & Segment Review, and Diagnostics. Zone control with 2 or 3 zones. Separate Type K 8 gauge thermocouples with ceramic protection tubes. hotkilns.com/dynatrol Genesis touch screen control optional (see page 27).

Model No.	Kiln Price	Furn Kit	Quad Elem	Control	Inside Diam	Inside Height	Cubic Feet	Exterior Dimensions	240V KW-Amp-Fuse	208V KW-Amp-Fuse	Ship Lbs	Lbs w/Kit
F1418-3	\$1600	\$155	\$175	One-Touch	13.5"	18"	1.5	22W x 31H x 27D	3.8-16-20	3.8-18.5-25	150	175
F1418-3-D	\$1750	\$155	\$175	DynaTrol	13.5"	18"	1.5	22W x 31H x 27D	3.8-16-20	3.8-18.5-25	150	175

More: See hotkilns.com/spec-fuego-usa for additional information like shipping dimensions, electrical ratings, fuse sizes and wire connection sizes. **Listings:** These kilns are not yet UL499 Listed.

LIBERTY-BELLE

16.5 or 17.5”D x 18”H

2.5 Cubic Feet

Plugs into Dryer Outlet

The perfect craft kiln and great for people who need to stay portable. The 12 foot cord plugs into your 30 amp dryer outlet!



Features & Benefits

This kiln is designed for the home. Sized at 2.5 cubic feet (16-1/2” diameter by 18” high) it features the intuitive One-Touch™ control, 3” of energy saving brick, a 12 foot long cord that plugs into a 30 amp dryer outlet, sectional construction for easy set up, cone 10 operation, fast heat up, ceramic element holders for durability and many other features. Easy to use and easy to move.

■ One-Touch™ Intuitive Kiln Control



Easily fire bisque and glaze programs (easy to adjust cone, delay, hold, heat-up and cool-down rates). Or create 4 custom ramp/hold programs. hotkilns.com/one-touch

- 12 foot long cord with Nema 14-30 dryer type plug
- Cone 10 • 2350°F • 1290°C
- Hard ceramic element holders
- Full support 14 gauge aluminized steel stand
- Solid peephole plugs with full 1” view
- Proprietary reflective brick coating
- c-MET-us listed to UL499 standards
- Three-year Limited Warranty

Options

Furniture Kit: Includes Cone 11 shelves. One full round and four half round shelves as listed above plus four each of 1”, 2”, 4” and 6” triangular posts. Prices below.

240, 220 or 208 single phase are all standard options. 3 phase not available. No Charge for any voltage options.

Quad Element System (watts & amps do not change - elements doubled & more massive with Quad system). Prices below.

Vent-Sure Vent 120 Volt. (Page 26).....\$520

ROLLING STAND

Rolling stand with locking casters (see page 28).....\$290

PLUG & CORD OPTIONS

Standard Nema 12 foot long 14-30 plug can be changed by customer to NEMA 14-50 (hardware is included to do this).

A 12 foot NEMA 6-30 plug, NEMA 15-50 or 6-50, NEMA 10-30 or NEMA 10-50 plug is available for prices below. A 6 foot long 6-50 plug available at no charge. All plugs can be changed in the field.

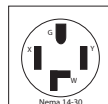

Standard

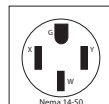

Standard

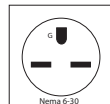

No charge

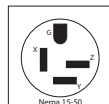

\$70

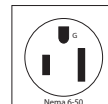

\$70

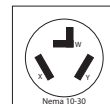

\$70

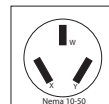

\$70

Model No.	Kiln Price	Furn Kit	Quad Elem	No. of Shelves F=full, H=half	Brick Thick	Inside Diam	Inside Height	Cubic Feet	Exterior Dimensions	240V KW~Amp~Fuse	208V KW~Amp~Fuse	Ship Lbs	Lbs w/Kit
LB18	\$1850	\$200	\$200	15.5” (1F, 4H)	2.5”	17.5”	18”	2.6	29W x 31H x 30D	5.7~23.9~30	5.0~23.9~30	200	240
LB18-3	\$1900	\$200	\$200	15” (1F, 4H)	3”	16.5”	18”	2.5	29W x 32H x 30D	5.7~23.9~30	5.0~23.9~30	215	250

More: See hotkilns.com/spec-liberty-belle for additional information like shipping dimensions, electrical ratings, fuse sizes and wire connection sizes. **UL499:** Listed by MET to UL499 Standards.

EASY-FIRE XT

Square Kilns with Easy-Fire Control Panel



Not
UL499
Listed

CONTROL OPTIONS

Genesis Touch Screen Control (N-G-GENS/OP)\$135
 KISS Computer Software (N-G-KISS/US)\$700
 Type S Platinum Thermocouples (T-G-SJUP/UG) \$250 each
 Pyrocil metallic Thermocouples (T-G-E23M/UG) \$44 each

Features & Benefits

- DynaTrol Dynamic Three Zone Control (Genesis touch screen control optional. See page 27).
- 4 Easy-Fire plus 6 Custom Programs
- Hard Ceramic Element Holders
- Cone 10 • 2350°F • 1290°C
- Full-View Solid Peephole Plugs
- Stainless Spring Hinge - Wide Open for Easy Loading (for the e2318-XT and e2327-XT. Note that the e2818-XT and e2827-XT use the spring-loaded DaVinci hinge - see page 16 for a typical photo)
- Full-Support Heavy-Duty 14 Gauge Aluminized Stand
- Fold Down Angled Panel for Easy Maintenance
- Same square body shape used in our DaVinci Series with strong arched sides with extra space added to interior dimensions for good air circulation
- 6-50 or 15-50 plug on most models (some are direct wired - see specification sheet)
- Three-year Limited Warranty

Options

Furniture Kit: Includes Cone 11 full shelves and half shelves as listed below plus a square post kit which includes six each 1/2", 1", 2", 4", 6" and 8" high 1-1/2" square cordierite posts plus heat-resistant gloves. Prices below.

Vent-Sure (120 volts) (M-V-VENT/00)\$520
 Vent Doubler (M-V-VENT/DB)\$155
 Vent Control (M-V-CNTL/00)\$160

Voltage Options: Order 240 or 208 volts, single or three phase, or international voltages. KW, amperage, and fuse size for each voltage below. 480 volts is not available. No Charge for any voltage options.

ELEMENT OPTIONS (PAGE 28)

Quad Element Option: Four rows of elements for each 9" kiln section. Maximum element life for constant high-firing. Pricing below.

APM Elements: Priced by Quote.

SEE PAGES 26-29 FOR THESE AND MORE OPTIONS

Model No.	Kiln Price	Furn Kit	Quad Elem	Shelves in Furn Kit	Inside W x D	Inside Height	Cubic Feet	External Dimensions	Stand KW	240/1 Amp-Fuse	240/3 Amp-Fuse	208/1 Amp-Fuse	208/3 Amp-Fuse	Lbs Kiln	Lbs w/Kit
E2318-XT	\$4100	\$405	\$290	(4) 20" x 10"	22" Square	18"	5.0	40W x 32H x 42D	9.5	39.4~50	34.1~50	45.5~60	39.4~50	500	550
E2327-XT	\$4625	\$515	\$400	(6) 20" x 10"	22" Square	27"	8.1	40W x 41H x 42D	11.5	48.8~60	27.1~40	48.0~60*	32.0~40	600	665
E2818-XT	\$5000	\$440	\$315	(4) 23" x 11.5"	26.5" Square	18"	7.8	45W x 32H x 43D	11.5	48.0~60	41.6~60	48.0~60*	48.0~60	625	695
E2827-XT	\$6125	\$570	\$460	(6) 23" x 11.5"	26.5" Square	27"	11.7	45W x 41H x 43D	14.9	48.0~60*	35.9~50	48.0~60*	41.4~60	735	835

Furniture Kit: Includes Cone 11 shelves listed above plus Large Square Post Kit and insulated gloves for unloading.

Cone Rating and Special High Amperage Models: Cone 10 for all voltages except 208 volts, single phase (which is Cone 1), and 240 volts, single phase (which is Cone 5). Most models have cords but a few require a direct hookup. *These models are available in a higher amperage/KW direct-wire cone 10 version. See hotkilns.com/spec-easy-fire-xt for shipping dimensions, electrical ratings, fuse and wire sizes, cone rating, and special higher KW models. **Listings:** These kilns are not yet UL499 Listed.

DAVINCI KILNS

Square & Rectangular Top-Loading Kilns

This is L&L's classic production kiln. Also great for Universities and high volume High School programs.



- DynaTrol with Dynamic Zone Control (2 zones in 18" high models, 3 zone in all other models)
- Cone 10 • 2350°F • 1290°C (All models)
- Counterbalanced Lid with springs inside of tubes
- Safety Latches for Lid
- Welded angle-iron powder-coated stand and hinge
- 3" brick with all brick construction (including lid)
- Strong arched sides with extra space added to interior dimensions for good air circulation
- Three elements per 9" section
- Ceramic Element Terminals
- Hard ceramic element holders
- Plug in kiln sections (except 480 volt models)
- Floor mounted control panel (except for X2300 series)
- c-MET-us listed to UL499 Standards

Features & Benefits

CONSTRUCTION

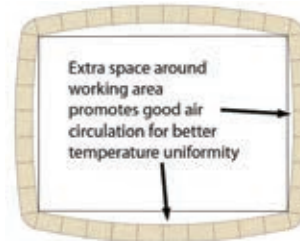

Sectional: Made of 9" high sections with a reversible bottom. The case is stainless steel wrapped around 3" of K23 highly insulating firebrick with 3 adjusting screw clamps per section.

Strong arched sides with extra space added to interior dimensions for good air circulation.

Spring-hinged counterbalanced top. Safety latch prevents lid from closing while loading. Design allows extra sections to be added and adjusted.

Firebrick is coated with a proprietary anti-dusting, hardening, & reflective coating.

Full-view solid ceramic peephole plugs are 1" diameter non-tapered with heat-locked head. There is one for each section.



ELEMENT HOLDER SYSTEM

Patented hard ceramic element holders protect brick and elements from wear and loading damage. All-ceramic element connection block and hard holders makes changing elements easy.

DYNAMIC ZONE CONTROL

DynaTrol with 4 Easy-Fire programs (Slow Bisque, Fast Bisque, Slow Glaze, Fast Glaze), 6 Vary-Fire custom programs, PreHeat, Delay, Program & Segment Review, and Diagnostics. Zone control with 2 or 3 zones. Separate Type K 8 gauge thermocouples with ceramic protection tubes. Genesis touch screen control optional (see page 27).

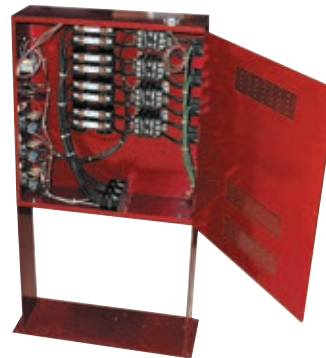

FLOOR STANDING PANEL

All controls and components are mounted in a separate control box mounted on the floor away from the kiln. Branch fused and neatly laid out circuits. On/off switch and control fuse included.

INSTRUCTIONS AND SUPPORT

Complete visual instructions with control reference, process information, assembly, troubleshooting, and parts list. Web videos show how to use the control. (hotkilns.com/videos)

Limited 3 year warranty. (hotkilns.com/warranty)

You can view all features of L&L Kilns at hotkilns.com/features

Options

FURNITURE KIT

Includes Cone 11 shelves as listed below plus one to three post kits which includes six each 1/2", 1", 2", 4", 6" and 8" high 1-1/2" square cordierite posts plus heat-resistant gloves. Prices below.



CONTROL OPTIONS (PAGE 27)

- Genesis Touch Screen Control (N-G-GENS/OP)\$135
- KISS Computer Software (N-G-KISS/US)\$700
- Type S Platinum Thermocouples (T-G-SJUP/UG) \$250 each
- Pyrociil metallic Thermocouples (T-G-E23M/UG) \$44 each
- High Limit Back Up Control (N-G-PKHL/00)\$640
- Back up Contactors Two-Section Kilns (N-G-BCX2/00).....\$390
- Back up Contactors Three-Section Kilns (N-G-BCX3/00) ...\$480
- Back up Contactors Four-Section Kilns (N-G-BCX4/00).....\$555
- Back up Contactors Five-Section Kilns (N-G-BCX5/00).....\$640

VENT OPTIONS

- Vent-Sure (120 volts) (M-V-VENT/00)\$520
- Vent Doubler (M-V-VENT/DB)\$155
- Vent Control (M-V-CNTL/00)\$160

SEE PAGES 26-29 FOR THESE AND MORE OPTIONS

VOLTAGE & POWER OPTIONS (PAGE 27)

XB and TB elements, which have a higher KW rating, are available on the 27", 36" and 45" high DaVinci kilns.

High Power OptionSee High Power prices below.

240 or 208 volts, single or three phase, or international voltages. KW, amperage, and fuse size for each voltage below. No Charge except for 480 volts. See page 27 for 480 volt description.

- 480 volts/3 phase\$750
- NEMA 1 Panel (required for MET-us Listing)\$750

CERAMIC FIBER LIDS

The lid firebrick is replaced with ceramic fiber modules mounted to a metal welded frame. 2600°F ceramic fiber is folded and formed into 4" thick modules that have an alloy support system inside. The internal support of the module is stud-welded to a metal frame that matches the



normal metal frame that we use in the firebrick lid. These lids will never crack or spall. The ceramic fiber is rated in temperature higher than the kiln rating so there is no concern about shrinkage of the fiber.

These fiber lids are available as either new equipment or as retrofit kits to fit older kilns. hotkilns.com/fiber-lid

- T2300 Fiber Lid for a new kiln (P-T-23FB/NW)\$1,325
- T3400 Fiber Lid for a new kiln (P-T-34FB/NW)\$1,450
- X3200 Fiber Lid for a new kiln (P-X-32FB/NW)\$1,225

Model No.	Kiln Price	Power Botm	High Power	Furn Kit	Quad Elem	Shelves in Furn Kit	Post Kits	Inside W x D	Inside Height	Inside Cubic Feet	External Dimensions	Stand KW	High KW	240/1 Fuse	240/3 Fuse	208/1 Fuse	208/3 Fuse	Lbs Kiln	Lbs w/Kit
XB2318-D	\$5200	n/a	n/a	\$405	\$280	(4) 20" x 10"	(1)	22" Square	18"	5.0	40W x 32H x 42D	8.9	n/a	50	40	60	50	600	650
X2327-D	\$5725	n/a	\$45	\$515	\$390	(6) 20" x 10"	(1)	22" Square	27"	8.1	40W x 41H x 42D	11.7	13.4	60	40	70	40	700	765
X2336-D	\$6550	n/a	\$85	\$785	\$520	(8) 20" x 10"	(2)	22" Square	36"	10.8	40W x 50H x 42D	15.6	17.9	80	60	90	60	775	870
X2345-D	\$7200	n/a	\$120	\$890	\$640	(10) 20" x 10"	(2)	22" Square	45"	13.5	40W x 59H x 42D	19.5	22.3	100	40	125	80	875	985
XB2818-D	\$6125	\$825	n/a	\$440	\$305	(4) 23" x 11.5"	(1)	26.5" Square	18"	7.8	45W x 32H x 43D	11.6	n/a	60	60	70	60	725	795
X2827-D	\$7375	\$825	\$65	\$570	\$440	(6) 23" x 11.5"	(1)	26.5" Square	27"	11.7	45W x 41H x 43D	14.9	17.4	80	50	90	60	835	935
X2836-D	\$8250	\$825	\$110	\$890	\$580	(8) 23" x 11.5"	(2)	26.5" Square	36"	15.6	45W x 50H x 43D	19.9	23.2	100	70	125	80	935	1075
X2845-D	\$9100	\$825	\$140	\$1020	\$755	(10) 23" x 11.5"	(2)	26.5" Square	45"	19.5	45W x 59H x 43D	24.9	29.0	125	90	150	100	1050	1220
XB3218-D	\$7000	\$990	n/a	\$535	\$365	(4) 28" x 14"	(1)	30.5" Square	18"	10.0	49W x 32H x 49D	14.2	n/a	80	70	90	80	880	985
X3227-D	\$8200	\$990	\$135	\$705	\$555	(6) 28" x 14"	(1)	30.5" Square	27"	15.0	49W x 41H x 49D	18.0	21.3	100	60	125	70	1000	1150
X3236-D	\$9325	\$990	\$155	\$1050	\$755	(8) 28" x 14"	(2)	30.5" Square	36"	20.0	49W x 50H x 49D	24.4	28.4	125	80	150	100	1135	1340
X3245-D	\$10,350	\$990	\$200	\$1225	\$920	(10) 28" x 14"	(2)	30.5" Square	45"	25.0	49W x 59H x 49D	30.5	35.5	175	125	200	125	1275	1525
TB2318-D	\$6925	\$1135	n/a	\$550	\$365	(6) 22" x 11"	(1)	26.5" x 34.75"	18"	9.7	54W x 32H x 43D	15.3	n/a	80	70	100	80	900	995
T2327-D	\$8100	\$1135	\$140	\$745	\$555	(9) 22" x 11"	(1)	26.5" x 34.75"	27"	14.6	54W x 41H x 43D	19.5	23.0	100	60	125	70	1035	1175
T2336-D	\$8925	\$1135	\$160	\$1100	\$755	(12) 22" x 11"	(2)	26.5" x 34.75"	36"	19.4	54W x 50H x 43D	26.0	30.7	125	90	150	100	1165	1355
T2345-D	\$10,050	\$1135	\$210	\$1300	\$920	(15) 22" x 11"	(2)	26.5" x 34.75"	45"	24.3	54W x 59H x 43D	32.5	38.4	175	125	200	125	1300	1530
TB3418-D	\$7475	\$1350	n/a	\$820	\$440	(6) 28" x 14"	(2)	30.5" x 43.5"	18"	13.8	62W x 32H x 49D	19.9	n/a	100	90	125	100	1065	1225
T3427-D	\$8750	\$1350	\$150	\$1085	\$670	(9) 28" x 14"	(2)	30.5" x 43.5"	27"	20.7	62W x 41H x 49D	24.9	36.5	125	80	150	90	1225	1455
T3436-D	\$10,125	\$1350	\$210	\$1330	\$895	(12) 28" x 14"	(2)	30.5" x 43.5"	36"	27.6	62W x 50H x 49D	33.3	39.9	175	125	200	125	1475	1775
T3445-D	\$11,900	\$1350	\$230	\$1815	\$1125	(15) 28" x 14"	(3)	30.5" x 43.5"	45"	34.5	62W x 59H x 49D	41.6	49.8	200	150	225	175	1675	2050

More: See various DaVinci specification sheets at hotkilns.com/spec-davinci for additional information like shipping dimensions, electrical ratings, fuse sizes and wire connection sizes. **Power Hookup:** Direct wired - no plugs. For controls see hotkilns.com/dynatrol and hotkilns.com/zone. **UL499:** Listed by MET to UL499 Standards.

Crating: Protected with wood crate and foam-in-place packaging for shipment by Common Carrier. Depending on the model there are either two or three crates. Some smaller models can ship in skidded cartons.

eFL SERIES KILNS

Front-Loading Kilns



- Front-Loading
- Arched Sides and Top (like DaVinci Kilns)
- Built-In Shelves and Kiln Shelf Storage
- DynaTrol Dynamic Three Zone Control
- 4 Easy-Fire plus 6 Custom Programs
- Hard Ceramic Element Holders
- Cone 10 • 2350°F • 1290°C
- Full-View Solid Peephole Plug
- Fold Down Panel for Easy Maintenance
- Door Switch

Features & Benefits

CONSTRUCTION

Door: Horizontal swing door. Heavy-gauge metal case with easily changed brick section. Hinge is adjustable in two planes. Includes extra insulation, and easy-to-use toggle clamps. The entire door is removable and swings 180 degrees to the case for easy moving of the kiln through doors.

Stand: Heavy gauge stand with two shelves. Levelling bolts and anchor holes included. Stand comes assembled in the US and Canada but can be disassembled for compact air shipment.

Optional Built-In Shelf Rack: A built in stainless steel shelf rack and shelf for posts saves space and hundreds of dollars. (Included for free with Furniture Kit.)

Construction: Stainless steel wrapped around brick clamped with adjustable screw clamps. Sides and top are arched for super-strength.

Assembly: Door is easily removable. All models fit through a 31" wide by 75" high door. Stand is removable.

Insulation: 3" K23 firebrick. Extra 1" of microporus super backup insulation on door to balance heat distribution.

Brick Coating: Proprietary reflective brick coating included. This

helps firebrick stay strong on the surface and helps prevent dusting.

Door Element Safety Switch: Honeywell limit switch turns power off to elements when the door is open. Included as standard equipment.

Peephole Plug: One solid ceramic plug with heat-locked head. 1" diameter full-view non-tapered. Located in door center.

ELEMENT HOLDER SYSTEM

Element Holder: Patented hard ceramic element holders protect brick and elements from wear and loading damage.

Element Design: Quad heavy-duty elements on sides and back. Low watt density for long life.

Element Connections: Proprietary all-ceramic element connection block makes changing elements easy.

DYNATROL ZONE CONTROL IN PIGGY-BACKED COOL-FIRE CONTROL PANEL

Uses the Easy-Fire Control panel (see page 2)

INSTRUCTIONS AND SUPPORT

Complete visual instructions. Web videos show how to use the control. (hotkilns.com/videos)

Limited 3 year warranty. (hotkilns.com/warranty)

Options

Furniture/Shelves Kit: Shelves are cone 11 high alumina shelves. Each post kit includes six each 1/2", 1", 2" 4", 6" and 8" high 1-1/2" square cordierite posts. All furniture kits include heat-resistant gloves. See below for pricing.

VENT-SURE DOWNDRAFT KILN VENT

Vent-Sure (120 volts) (M-V-VENT/00)\$520
 Vent Doubler (M-V-VENT/DB)\$155
 Vent Control (M-V-CNTL/00)\$160

This kiln comes with a special bypass collection box with a long tube protruding from the back of the kiln base.

VOLTAGE OPTIONS

Order 240 or 208 volts, single or three phase, or international voltages. KW, amperage, and fuse size for each voltage below. 480 volts is not available. No Charge for any voltage options.

CONTROL OPTIONS

Genesis Touch Screen Control (N-G-GENS/OP)\$135
 KISS Computer Software (N-G-KISS/US)\$700
 Type S Platinum Thermocouples (T-G-SJUP/UG) \$250 each
 Pyrocil metallic Thermocouples (T-G-E23M/UG)\$44 each

ROLLING CASTER SYSTEM

Locking Swivel Casters\$430

SEE PAGES 26-29 FOR THESE AND MORE OPTIONS

Genesis control, KISS software, vent options and more.

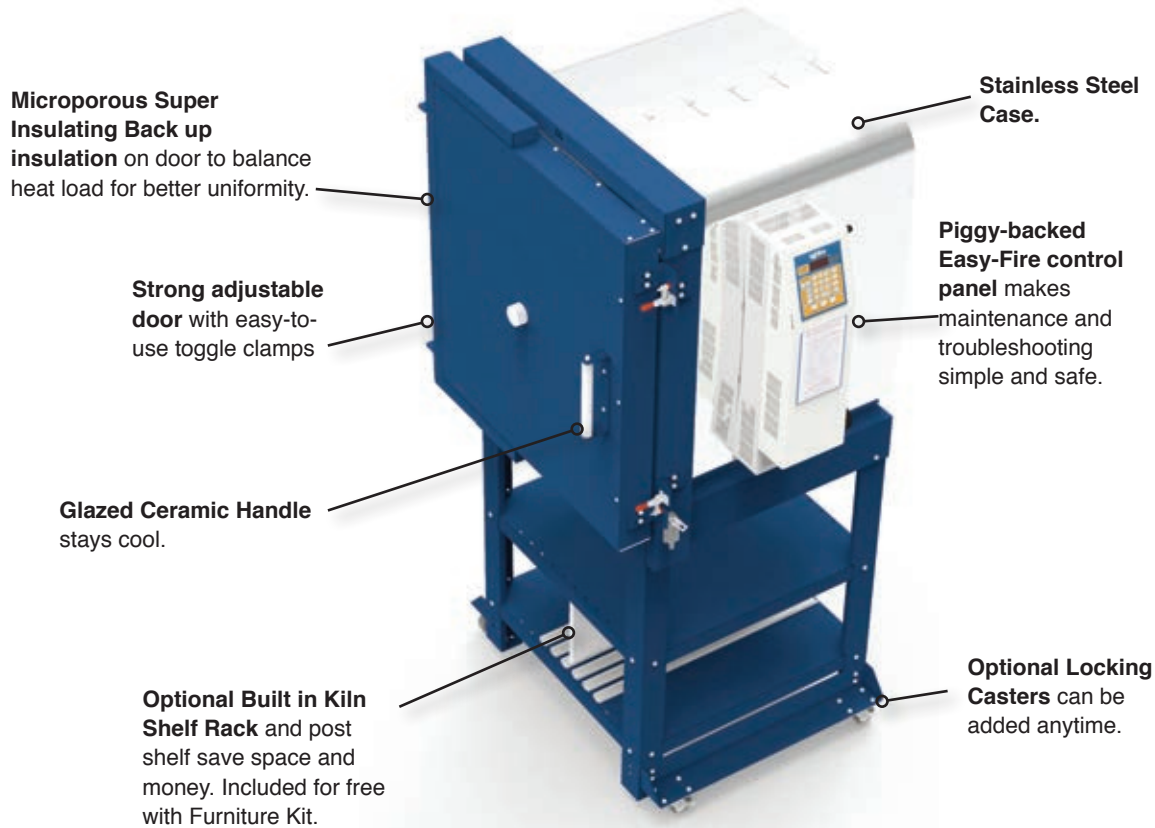

Model Number	Kiln Price	Furn Kit	Number of Shelves	Cubic Feet	Hearth Height	Inside Dimensions	Exterior Dimensions	240/1 KW-Amp-Fuse	240/3 KW-Amp-Fuse	208/1 KW-Amp-Fuse	208/3 KW-Amp-Fuse	Lbs Kiln	Lbs w/Kit
eFL1616	\$3900	\$320	(2) 14"x 24"	4.0	40"	17W x 16H x 26D	33W x 64H x 33D	9.0~37.5~50	9.0~32.5~50	9.0~43.3~60	9.0~37.5~50	390	445
eFL1626	\$4775	\$480	(3) 14"x 24"	6.6	40"	17W x 26H x 26D	33W x 73H x 33D	11.5~48.0~60	12.5~30.1~40	10.0~48.0~60*	12.5~34.7~50	560	655
eFL2026	\$5325	\$560	(6) 10"x 24"	8.6	40"	20W x 26H x 26D	38W x 73H x 33D	13.3~55.4~70	13.3~32.0~40	13.3~64.0~80	13.3~36.9~50	570	670
eFL2626	\$5900	\$670	(6) 12"x 24"	10.2	40"	26W x 26H x 26D	43W x 73H x 33D	15.4~64.0~80	15.4~37.0~50	15.4~73.9~100	15.4~42.6~60	600	700
eFL2635	\$6675	\$800	(8) 12"x 24"	13.7	32"	26W x 35H x 26D	43W x 74H x 33D	19.2~80.0~100	19.2~52.9~70	19.2~92.3~125	19.2~61.1~80	660	765

All models are rated to Cone 10 except the 208 volt single phase eFL1626 which is rated to Cone 5. * A special model eFL1626-208-X is rated at Cone 10 but has 56.0 amps with a 70 amp fuse and is wired direct. **Plugs on US Models only:** 6-50 on single phase and 15-50 on three phase for all eFL1616 models, all eFL1626 models except the special eFL1626-208-X, 3 phase eFL2026, and 3 phase eFL2626. All other models are direct wired. **More:** See eFL Specification Sheets at hotkilns.com/spec-eFl for shipping dimensions, electrical ratings, fuse and wire sizes. **Listings:** These kilns are not yet UL499 Listed.

HERCULES KILNS

Professional Medium Front-Loading Kilns



This medium-sized front-loading kiln has elements in the door, gasketed door with plug heat lock, 4-1/2" arched brick roof, door shut-off switch, removable stand, separated cool-firing control panel, powder-coated heavy fabricated case and more.



Woven tadpole fiberglass door gasket for superior door seal



4-1/2" thick K25 Full Arch for extra strength



Door Elements for Even Heating



Thick Powder-Coated Steel Case



Welded Stand (can be removed on Hercules kilns). Move by pallet jack from all four sides.



Safety Door Switch shuts off power when door is opened.

Features & Benefits for Hercules & Easy-Load

- Adjustable door with plug seal and fiberglass tadpole gasket for tight seal
- Heavy 12 and 10 gauge welded powder-coated case with stand and leveling pads
- Extra-tough High Temperature 2500°F 4-1/2" firebrick arch. Other insulation is 3" of K23 brick with 2" of mineral wool backup insulation
- Elements on door, sides and back for even firing
- Door power safety shut-off switch
- Hard ceramic element holders
- DynaTrol with Dynamic Zone Control (2 zones for EL2424-H, 3 zones for all others). (Optional Genesis touch screen control. See page 27).
- Type K 8 gauge thermocouples with ceramic protection tubes
- Control panel mounted with air space between it and the case
- Branch fusing in control panel
- Solid peephole plugs with full 1" view in the door (2 for EL2424H, 3 for all others)
- Proprietary reflective brick coating that protects brick and minimizes dusting
- MET-us listed to UL499 standards

MANUAL VENTILATION AND COOLING SYSTEM

There is a 2-3/4" by 1-7/8" brick plug on the top of the kiln and a sliding damper on the bottom to allow you to introduce cool air into the kiln without opening the door. (Note: this is not meant to

Model No.	Furn Price	Inside Kit	Dimensions	Cubic Feet	Hearth Size	Shelves in Furn Kit	Hearth Height	KW	240/1 Amp-Fuse	240/3 Amp-Fuse	208/1 Amp-Fuse	208/3 Amp-Fuse	480/3 Amp-Fuse	Lbs Kiln	Lbs w/Kit
EL2424H	\$9375	\$405	25W x 25D x 24H	8	22" x 22"	(4) 11" x 22"	30"	15.0	63.0~80	55.0~70	73.0~100	63.0~80	28.0~40	1075	1250
EL2427H	\$10,275	\$525	25W x 25D x 27H	9	22" x 22"	(6) 11" x 22"	30"	15.0	68.8~90	39.6~50	79.3~100	45.7~60	19.8~25	1200	1450

Furniture Kit: Includes the Cone 11 shelves listed above plus the Large Square Post Kit and insulated gloves for unloading. **More:** See hotkilns.com/spec-hercules for additional information like shipping dimensions, electrical ratings, fuse sizes and wire connection sizes.

Power Hookup: Direct wired. For controls see hotkilns.com/dynatrol and hotkilns.com/zone. **UL499:** Listed by MET to UL499 Standards.

EASY-LOAD KILNS

Professional Large Front-Loading Kilns



These are excellent kilns for large studios, universities, and advanced high schools as well as for industrial applications. This is a fully loaded EL2436.

Big, strong, well-built - if you need a large front-loading kiln we have it. L&L has been building front-loading kilns for over 65 years. Includes the same features as the Hercules.

Options for Hercules & Easy-Load

FURNITURE KIT

Includes Cone 11 full shelves and half shelves as listed below plus a post kit which includes six each 1/2", 1", 2" 4", 6" and 8" high 1-1/2" square cordierite posts plus heat-resistant gloves. Prices below.

VENT-SURE DOWNDRAFT KILN VENT (PAGE 26)

Vent-Sure (120 volts) (M-V-VENT/00)\$520
 Vent Doubler (M-V-VENT/DB)\$155
 Vent Control (M-V-CNTL/00)\$160

SPECIAL HINGE MOUNTING

Hinge mounted on right. Note: Control panel stays on the right-hand side. (Allow 4 weeks extra production time).....\$1020

CONTROL OPTIONS (PAGE 27)

Genesis Touch Screen Control (N-G-GENS/OP)\$135
 KISS Computer Software (N-G-KISS/US)\$700
 Type S Platinum Thermocouples (T-G-SJUP/UG) \$250 each
 Pyrocil metallic Thermocouples (T-G-E23M/UG)\$44 each
 High Limit Back Up Control (N-G-PKHL/00)\$640
 Back up Contactors EL2424 (N-G-BCE2/00)\$390
 Back up Contactors (All other models) (N-G-BCE3/00)\$480

VOLTAGE OPTIONS (PAGE 27)

240 or 208 volts, single or three phase, or international voltages. KW, amperage, and fuse size for each voltage below. No Charge except for 480 volts.

480 volts/3 phase\$750
 NEMA 1 Panel (required for MET-us Listing)\$750

Model No.	Price	Furn Kit	Inside Dimensions	Cubic Feet	Hearth Size	Shelves in Furn Kit	Hearth Height	KW	240/1 Amp-Fuse	240/3 Amp-Fuse	208/1 Amp-Fuse	208/3 Amp-Fuse	480/3 Amp-Fuse	Lbs Kiln	Lbs w/Kit
EL2436	\$15,075	\$815	25W x 25D x 36H	12	22" x 22"	(8) 11" x 22"	29"	19.0	80.0~100	46.0~60	92.0~125	53.0~70	24.0~30	1350	1500
EL2448	\$18,400	\$935	25W x 25D x 48H	16	22" x 22"	(10) 11" x 22"	18"	24.2	101.0~125	59.0~80	117.0~150	68.0~90	30.0~40	1500	1750
EL2848	\$19,750	\$1250	31W x 25D x 48H	20	28" x 24"	(12) 14" x 24"	18"	27.0	113.0~150	66.0~90	130.0~175	75.0~100	33.0~50	1750	2000
EL3048	\$22,875	\$1300	31W x 31D x 48H	25	28" x 28"	(12) 14" x 28"	18"	31.5	132.0~175	76.0~100	152.0~200	88.0~125	39.0~50	2000	2300

Furniture Kit: Includes Cone 11 shelves listed above plus 2 Large Square Post Kits and insulated gloves for unloading. **More:** See hotkilns.com/spec-easy-load for additional information like shipping dimensions, electrical ratings, fuse sizes and wire connection sizes. **Power Hookup:** Direct wired. For controls see hotkilns.com/dynatrol and hotkilns.com/zone. **UL499:** Listed by MET to UL499 Standards.

Shipping & Moving: All the kilns except the EL3048 will go through a 34-1/2" wide by 75" high door. The EL3048 needs a minimum door size of 40-1/2" wide by 76" high. All Easy-Load and Hercules kilns can be moved with a pallet-jack from any side. Crated with interior support and air-cushion skids. Shipping by air-ride truck. Fill out installation checklist prior to order: hotkilns.com/front-load-checklist.

DAVINCI BELL-LIFT KILNS



Features & Benefits

Availability: DaVinci X3200-D & T3400-D Kiln Series. Also a special version exists for much larger kilns (TB644754-D).

Application: A common complaint concerning top loading kilns, the larger ones in particular, is that it is difficult to load them. This is especially true for larger pieces, and in a production environment this labor intensive job can become very expensive over time. Moreover, some people simply aren't capable of doing this strenuous and heavy lifting. Front loading kilns are often desired because they seem to be easier to load, however, it is still a strain to put a heavy piece into the back of a front-loading kiln and these kilns are generally more expensive and difficult to move. Shuttle kilns or envelope kilns work well for loading but they are also very expensive. Bell-lift kilns are one good solution for this problem.

How it Works: The Bell-Lift accessory lifts the whole kiln up as a unit exposing the bottom of the kiln for loading from all four sides. The kiln sections and top are held together as one unit with a metal support frame. This unit is lifted up with a ratcheted hand winch mounted on the external frame. (Electric winches are available as an upgrade.) There are manual safety pins that lock the kiln in place when the kiln is fully raised.

Construction: This whole support frame is made from powder-coated heavy duty welded parts that are easily assembled on site so that the system can be easily broken down for inexpensive common carrier shipping. (It is a two to three person job to assemble the kiln. Only simple tools, like wrenches are required).

Dimensions

Height: A 18", 27" or 36" high kiln (interior) will be 105" high, and a 45" high kiln will be 123" high.

Specification sheet: hotkilns.com/spec-bell-lift

Options

For Electric Winch see hotkilns.com/bell-lift-electric-winch-video.

Motorized Winch (instead of hand winch)\$1325

Model No.	Kiln Price	Power Botm	High Power	Furn Kit	Quad Elem	Shelves in Furn	Post Kits	Inside W x D	Inside Height	Inside Cubic Feet	External Dimensions	Stand KW	High KW	240/1 Fuse	240/3 Fuse	208/1 Fuse	208/3 Fuse	Lbs Kiln	Lbs w/Kit
XB3218-BL	\$12,875	\$990	n/a	\$535	\$365	(4) 28" x 14"	(1)	30.5" Square	18"	10.0	49W x 105H x 49D	14.2	n/a	80	70	90	80	1630	1735
X3227-BL	\$13,090	\$990	\$135	\$705	\$555	(6) 28" x 14"	(1)	30.5" Square	27"	15.0	49W x 105H x 49D	18.0	21.3	100	60	125	70	1750	1900
X3236-BL	\$14,150	\$990	\$155	\$1050	\$755	(8) 28" x 14"	(2)	30.5" Square	36"	20.0	49W x 105H x 49D	24.4	28.4	125	80	150	100	1885	2090
X3245-BL	\$15,145	\$990	\$200	\$1225	\$920	(10) 28" x 14"	(2)	30.5" Square	45"	25.0	49W x 123H x 49D	30.5	35.5	175	125	200	125	2075	2325
TB3418-BL	\$12,375	\$1350	n/a	\$820	\$440	(6) 28" x 14"	(2)	30.5" x 43.5"	18"	13.8	62W x 105H x 49D	19.9	n/a	100	90	125	100	1815	1975
T3427-BL	\$14,150	\$1350	\$150	\$1085	\$670	(9) 28" x 14"	(2)	30.5" x 43.5"	27"	20.7	62W x 105H x 49D	24.9	36.5	125	80	150	90	1975	2205
T3436-BL	\$15,525	\$1350	\$210	\$1330	\$895	(12) 28" x 14"	(2)	30.5" x 43.5"	36"	27.6	62W x 105H x 49D	33.3	39.9	175	125	200	125	2225	2525
T3445-BL	\$17,300	\$1350	\$230	\$1815	\$1125	(15) 28" x 14"	(3)	30.5" x 43.5"	45"	34.5	62W x 123H x 49D	41.6	49.8	200	150	225	175	2475	2850

More: See various DaVinci specification sheets at hotkilns.com/spec-davinci for additional information like shipping dimensions, electrical ratings, fuse sizes and wire connection sizes. **Power Hookup:** Direct wired - no plugs. For controls see hotkilns.com/dynatrol and hotkilns.com/zone.

Crating: Protected with wood crate and foam-in-place packaging for shipment by Common Carrier. Depending on the model there are either two or three crates. Some smaller models can ship in skidded cartons.

JUMBO BELL-LIFT KILNS

100 Cubic Foot Industrial Kiln
Model TB644754



MORE INFORMATION

General Dimension Drawings:

See hotkilns.com/general-dimension-drawing-tb644754

See hotkilns.com/jumbo-bell-lift-kilns for more photos and assembly information.

Pricing..... Priced by Quote

Features & Benefits

Temperature Rating: Cone 10, 2350°F, 1290°C

Loading: The kiln lifts up with an electric winch. Safety latches hold the kiln in place while kiln is loaded.

Assembly: 9" high sections stack on top of each other. Frame easily bolts together. A forklift or overhead crane should be used in the assembly.

Kiln Construction: Unique shallow side arches create super-strong sides and allow for plenty of space for air circulation.

Insulation: 3" K23 firebrick on sides and top. 4" ceramic fiber module top (RCF or Non-RCF depending on maximum temperature required).

Brick Coating: Reflective coating protects brick and reduces dusting.

Element Holders: Ceramic holders protect brick.

Elements: Heavy-duty. 3 elements per 9" high section.

Control Panel: Floor mounted NEMA 1 panel separate from kiln. Kiln sections attached to panel with 105°C cords. Mechanical contactors with control relays. Branch fusing. An On/Off switch and control fuse are included. Direct electrical hook-up to terminal block.

Control: DynaTrol with 4 Easy-Fire programs, 6 Vary-Fire programs, PreHeat, Delay, Program & Segment Review, and Diagnostics. (Others available - see Control options on page 27)

Zone Control: Three zone.

Peephole Plugs: Non-fragile solid ceramic with heat-locked head. 1" diameter full-view non-tapered. One per section.

Thermocouples: Type K 8 gauge with ceramic protection tubes.

Relays: Mercury free relays.

Instructions: Complete instructions with control reference, troubleshooting, and parts list. Web videos show how use the control. There is also a video showing the bell-lift raising and lowering. (hotkilns.com/jumbo-bell-kilns-raising)

Warranty: Limited 3 year warranty. (See hotkilns.com/warranty.pdf).

Specifications

Voltage: 480/3P **KW:** 87.8

Amps: 106 **Fuse:** 150 amps **Wire Size:** 2/0

Inside Dimensions: 66" W x 47"D x 54"H

Outside Dimensions: 96" W x 74" D x 160" H

Minimum Space Requirements: 120" wide by 98" deep by 165" high.

Ship Weight: 4000 lbs. Ships on a dedicated truck.

CUSTOM, INDUSTRIAL & COMMERCIAL KILNS

Years of Custom Design Experience



L&L kilns are used in many industries including advanced industrial ceramics, abrasives, aerospace, piezo ceramics, optical glass, heating processes, melting, preheating for welding, annealing, stress-relieving, solution hardening, calcining, and steel heat treating.

The wide range of standard designs and built-in heavy-duty durability features allow L&L to quickly and economically configure many designs for rigorous production use.

Special industrial controls are available from Eurotherm, Honeywell, Watlow and others.

Our sister company, L&L Special Furnace Co., Inc., makes aerospace grade heat treating furnaces.

Call L&L to discuss your needs. We have years of experience to share.

hotkilns.com/industry

LARGE FRONT-LOAD KILNS



hotkilns.com/large-custom-front-loading-kilns

We design and build special larger front-loading kilns beyond the standard EL sizes.

CAR BOTTOM KILNS

hotkilns.com/car-bottom-kilns



The ELC3648 Car Kiln works with a standard pallet jack for easy moving of the car and great sealing.

L&L also makes large traditional car bottom and shuttle kilns.

CUSTOM LARGE POLYGONAL KILNS

hotkilns.com/large-polygonal-kilns

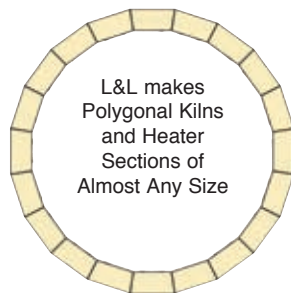

L&L makes
Polygonal Kilns
and Heater
Sections of
Almost Any Size



Custom polygonal kilns with 4-1/2" of firebrick are available by special quote. L&L can make almost any diameter and any height in multiples of 9" high sections. There are three elements per 9" high section. The base is made of welded angle-iron with leveling bolts. The bottom is typically 4-1/2" of K23 brick. These are typically cemented in sections and then held together with a stainless steel band. The top is typically made of 4" thick folded and formed ceramic fiber modules. Temperatures are limited to 2350°F (1285°C).



LARGE SQUARE & RECTANGULAR KILNS

hotkilns.com/custom-davinci-kilns

L&L designs and builds custom square and rectangular DaVinci kilns. Sizes are very flexible. The top is typically made of 4" thick ceramic fiber modules.



SPECIAL ALLOY RETORTS FOR ATMOSPHERE CONTROL

We design special high temperature retorts using various alloys like 316, 330 and Inconel 601 for high temperature work in a controlled environment.

Industrial kilns are all by special quote and are only sold direct by the factory. Send an email with your requirements. Be sure to include process, size and temperature requirements. Send email to industry@hotkilns.com

OPTIONS AND ACCESSORIES

VENT-SURE DOWNDRAFT KILN VENT SYSTEM

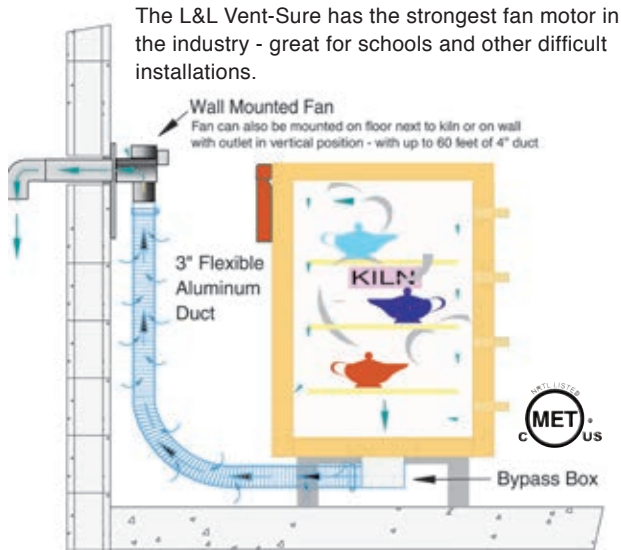

The L&L Vent-Sure has the strongest fan motor in the industry - great for schools and other difficult installations.

Wall Mounted Fan
Fan can also be mounted on floor next to kiln or on wall with outlet in vertical position - with up to 60 feet of 4" duct.

3" Flexible Aluminum Duct

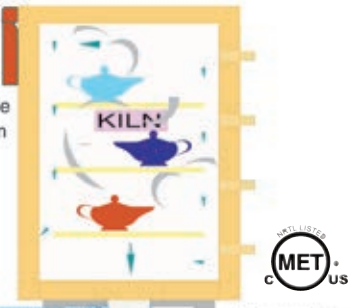

Bypass Box

MORE INFORMATION: hotkilns.com/vent-sure

Features

- Downdraft venting pulls air down to bottom of kiln
- Improves temperature uniformity inside the kiln
- Powerful 130 CFM fan motor, typically mounted on wall, allows fumes to be under vacuum in your studio
- The strong fan motor helps overcome static pressure in long exhaust lines. The duct may be up to 60 feet in length, and include up to four 90° bends
- 120 volts with on/off switch on cord (240 volts available)
- 15 foot long flexible aluminum duct
- Bypass collection box mounted on kiln allows adjustment of venting.
- Fan motor, mounted away from the kilns, stays cool and no vibration transmitted to the kiln
- Three-year Limited Warranty
- c-MET-us Listed to UL499 standards for use on c-MET-us L&L Kilns (Easy-fire, School-Master, Jupiter, Davinci, Ergo-Lift). MET-us Listed to UL499 standards on Hercules, and Easy-Load kilns).

PRICES

Vent-Sure for 120 Volts (primarily used in the USA)

M-V-VENT/00\$520

Vent-Sure for 220-240 Volts (Usually non-USA)

M-V-VENT/EU\$570

VENT OPTIONS

MULTI-MOUNT BRACKET



A special Multi-mounting bracket is available to mount the vent motor on the floor or point the outlet vertically for ceiling installations. (hotkilns.com/multi-mounting)

M-V-MULT/00\$28

VENT DOUBLER

You can get a vent doubler option which allows you to vent two kilns that are each up to 10 cubic feet. (Note: Consider buying the Multi-Mount Bracket). Includes all parts necessary to vent two kilns - up to 10 cubic feet each with one vent.

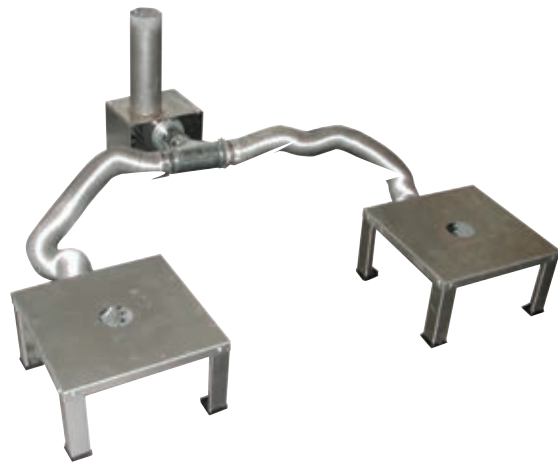

(hotkilns.com/doubler)

M-V-VENT/DB\$155

VENT CONTROL



The Vent Control allows you to automatically control the operation of the Vent-Sure kiln vent with one of the outputs from the DynaTrol (or Genesis). (hotkilns.com/vent-control)

M-V-CNTL/00\$160

CONTROL & POWER OPTIONS

GENESIS TOUCH SCREEN CONTROL

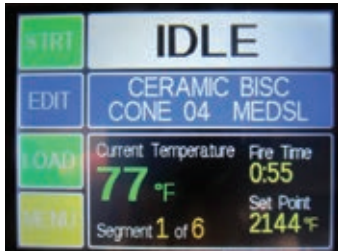

The Genesis control from Bartlett includes a touch screen interface and WIFI connectivity added to the proven software of the DynaTrol. Available on any kiln that would get a DynaTrol. Now includes a phone app that monitors temperatures in the kiln.

(hotkilns.com/genesis-touch-screen-control)
N-G-GENS/OP\$135

KISS SOFTWARE

Kiss (kiln interface software system) connects up to 50 DynaTrol controllers to a personal computer running Windows. Monitor and control kiln remotely. For the DynaTrol and Genesis only.

(hotkilns.com/kiss)
Kiln Kit Package for Extra Kilns (N-G-KISS/KK)\$68
KISS Starter Kit with USB Connection (N-G-KISS/US).....\$700

HIGH LIMIT BACK UP CONTROL

Bartlett High Limit Control with latching relay acts as a back up to the main control. If the main control fails for any reason then this acts as a "back stop" and shuts the kiln down. Available on Jupiter, DaVinci, Hercules and Easy-Load kilns only.

(hotkilns.com/high-limit)
N-G-PKHL/00\$640

BACK UP CONTACTORS

Actuated by the High Limit Back Up Digital Control, back up contactors are completely redundant power contactors so that if one or more contactors fail in a closed position then the kiln still cannot climb above the High Limit set point. Needs a large box. Available on Jupiter, DaVinci, Hercules and Easy-Load kilns only.

(hotkilns.com/high-limit)
Jupiter Two-Section Kilns (N-G-BCJ2/00).....\$170
Jupiter Three-Section Kilns (N-G-BCJ3/00).....\$225
Jupiter Four-Section Kilns (N-G-BCJ4/00).....\$280
Jupiter Five-Section Kilns (N-G-BCJ5/00)\$340
DaVinci Two-Section Kilns (N-G-BCX2/00).....\$390
DaVinci Three-Section Kilns (N-G-BCX3/00).....\$480
DaVinci Four-Section Kilns (N-G-BCX4/00).....\$555
DaVinci Five-Section Kilns (N-G-BCX5/00)\$640
EL2424 (N-G-BCE2/00)\$390
EL2427 & All Easy-Load Kilns (N-G-BCE3/00).....\$480

120 VOLT POWER SUPPLY

If there are problems with short power outages, voltage spikes, voltage drops, or excessive environmental line noise, this can cause unpredictable behavior in the electronic control. With this option the control is powered by a separate 120 volt line (with a standard 6 foot long cord) and that voltage is filtered through an EMI (Electrical Magnetic Interference) noise filter. Available on all kilns. (hotkilns.com/noise) L-G-EMIF/00\$220

SOLID STATE RELAYS

Optional Solid State Relays..... Priced by Quote

INDUSTRIAL CONTROLS

Eurotherm and other industrial controls are available. Available on DaVinci, Jupiter and Easy-Load kilns only. (hotkilns.com/eurotherm3) Priced by Quote

480 VOLTS/3 PHASE



Available for Jupiter 28" diameter kilns, DaVinci kilns, Hercules, and Easy-Load kilns. Kiln sections are hard wired to power box with flexible cords. (hotkilns.com/480)\$750

NEMA 1 CONTROL BOX:

480 volts becomes MET-us listed with this extra option. Also used in industrial applications.....\$750

THE POSITIVE DOOR INTERLOCK SWITCH



Features a strong mechanical latch that must be turned before the door can be opened. The turning of this latch breaks all power to the kiln as if you had used an external power disconnect switch or pulled the power cord from its socket.

Only available on Easy-Fire and School-Master kilns. (hotkilns.com/door-interlock) K-E-LATC/00\$320

THERMOCOUPLE OPTIONS

TYPE S THERMOCOUPLES

The best thermocouple for constant high fire applications. No thermocouple drift. Priced per thermocouple. For a single zone control you will need one, a two zone kiln two, a three zone control three. Note that kilns with four or more sections still only have a three zone control. (hotkilns.com/type-s)
T-G-SJUP/UG (Price per thermocouple).....\$250

PYROCIL SHEATHED THERMOCOUPLES

For greater sensitivity to temperature change. Use below 2200°F for sensitivity (glass is a good example). See above note about quantity required for Type S thermocouples. (hotkilns.com/pyrocil-tc) T-G-E23M/UG (Price per thermocouple)\$44

OPTIONS AND ACCESSORIES

ELEMENT OPTIONS

QUAD ELEMENT OPTION

Four rows of elements for each 9" kiln section. For maximum high-fire element life. The combination of 1/2" diameter element coils, the doubled surface area of the Quad element design, and superior heat transfer of L&L's patented ceramic element holders, make this the best element system in the world today. Available on most L&L kilns as an option. Standard on eQuad-Pro and JH Series. (hotkilns.com/quad) See Price Grids



APM SINTERED ELEMENTS

Available as a special option. Increases element life in certain situations. (hotkilns.com/apm) Priced by Quote

UNPOWERED SHORT SECTIONS

These rings are 4-1/2" high and can be put anywhere on the sectional Jupiter and DaVinci kilns.

(hotkilns.com/unpowered-sections-jupiter-kilns)

(hotkilns.com/unpowered-sections-davinci-kilns)

See hotkilns.com/parts and filter for unpowered sections to get pricing.

POWERED BOTTOMS

Available on some Jupiter and DaVinci kilns See price grids



STAND OPTIONS

ROLLING KILN STAND

L&L's rolling kiln stand features heavy gauge (14 ga) galvanized steel construction with multiple bends for extra strength, steel swivel locking casters, integrated vent collection box support, and guide rails for the kiln. Each size is fitted to the kiln.

Important special caution plates are riveted to three sides of the stand. The vent collection box is not included but, when you order a Vent-Sure vent system the longer duct is included with the system.



- Rolling Stand for 8 Sided Kiln (A-J-18RL/00)\$290
- Rolling Stand for 10 Sided Kiln (A-J-23RL/00).....\$345
- Rolling Stand for 12 Sided Kiln (A-J-28RL/00).....\$375

SEISMIC KILN RACK AND BRACE

This special stand is designed to prevent a top-loading sectional kiln from falling over during an earthquake.

(hotkilns.com/earthquake-resistant-brace)

Seismic Stand for any 14" to 28" polygonal kiln up to 45" high\$525

Other kilns Priced by Quote

CUSTOM OPTIONS

Discuss your custom needs with us. We customize our kilns for industrial applications and special ceramic needs. We can make very tall kilns, very large diameter kilns, add special holes, make ceramic fiber tops, use mercury relays and SSRs, add insulation. We have many years of industrial and special design experience.

SUPERIOR KILN FURNITURE



SQUARE POSTS ARE CUT SQUARE

L&L sells the highest grade ceramic extruded posts. They are

very straight (even in lengths up to 12" long), precision cut for squareness (which makes shelves stable), and are strong without being excessively thick.

Posts & Post Kits

POST KITS

Large Square Post Kit

(Six each 1/2", 1", 2", 4", 6" & 8" square posts) (C-G-SPKT/LG) \$175

Small Square Post Kit

(Four each 1/2", 1", 2", 4", 6" & 8" square posts) (C-G-SPKT/SM)..... \$115

DL Series Post Kit

(Four each of 1/2", 1", 1-1/2", 2", 2-1/2", 3" and 4" triangular posts) (C-G-TPKT/DB)..... \$72

Liberty-Belle Post Kit

(Four each 1", 2", 4" & 6" triangular posts) (C-G-TPKT/LB) \$48

Large Triangular Post Kit

(Six each 1/2", 1", 1-1/2", 2", 2-1/2", 3", 4", 5" & 6" triangular posts) (C-G-TPKT/01)..... \$140

Small Triangular Post Kit

(Four each 1", 2", 3", 4", 5" & 6" triangular posts) (C-G-TPKT/00) \$76

SQUARE POSTS (1-1/2" SQUARE)

1/2" Square Post (C-G-S005/00) \$2.85

1" Square Post (C-G-S010/00) \$3.90

2" Square Post (C-G-S020/00) \$4.40

4" Square Post (C-G-S040/00) \$4.95

6" Square Post (C-G-S060/00) \$6.00

8" Square Post (C-G-S080/00) \$7.00

TRIANGULAR POSTS

NOTE: Single triangular posts are available on the web.

FREIGHT FOR SHELVES AND FURNITURE KITS

Depending on the quantity and size of shelves, posts and furniture kit(s) ordered, the order may have to ship by common carrier freight. Skid/carton charge..... \$50

Round & Polygonal Shelves

11" DIAMETER KILNS

For Doll/Test Kilns

Full Round 9" diameter shelf (3/8" thick) (H-D-9000/00) \$30

14" DIAMETER KILNS

For Fuego Kilns (with 3" brick)

Full Round 12" diameter (1/2" thick) (H-J-1200/00) \$35

For J14 Kilns (with 2-1/2" brick)

Full Round 13" diameter (1/2" thick) (H-J-1300/00) \$35

Half Round 13" diameter (1/2" thick)

(H-J-1350/00) \$21

16-1/2" DIAMETER KILNS

For LB18-3, e18S-3 & e18T-3, and J18-3 kilns with 3" brick

Full Round 15" diameter (5/8" thick) (H-J-150A/00) \$44

Half Round 15" diameter (5/8" thick)

(H-J-155A/00) \$26

17-1/2" DIAMETER KILNS

For LB18, e18S & T, and J18 kilns with 2-1/2" brick

Full Octagonal 15-1/2" diameter (5/8" thick) (H-J-1500/00) \$44

Half Octagonal 15-1/2" diameter (5/8" thick)

(H-J-1550/00) \$26

22" DIAMETER KILNS

For e23S-3, e23T-3, SM23T-3, & J2300-3 kilns with 3" brick

Full Round 20" diameter (3/4" thick) (H-J-2000/00) \$84

Half Round 20" diameter (3/4" thick)

(H-J-2050/00) \$43

23" DIAMETER KILNS

For e23S, e23T, SM23T & J2300 kilns with 2-1/2" brick

Full Round 21" diameter (3/4" thick) (H-J-2100/00) \$84

Half Round 21" diameter (3/4" thick)

(H-J-2150/00) \$44

28" & 29" DIAMETER KILNS

For e28S, e28T, SM28T, J2900 Series with 2-1/2" or 3" brick

Half Round 25-1/2" diameter (3/4" thick)

(H-J-2650/00) \$73



HIGH ALUMINA SHELF MATERIAL CONE 11 RATING

All shelves are made of a press-molded (not cast) high alumina cordierite body that holds up to Cone 11 firing with little warping.

Rectangular Shelves

SQ1818, SQ1827, EL1824, EL3648 X1800 SERIES

8" x 16" rectangular (5/8" thick)

(H-S-1608/00) \$38

16" x 16" square (3/4" thick)

(H-S-1616/00) \$73

X2300 SERIES, E2318XT, E2327XT

10" x 20" rectangular (5/8" thick)

(H-X-2010/00) \$51

X2800 SERIES, E2818XT, E2827XT

11-1/2" x 23" rectangular (3/4" thick)

(H-X-2311/00) \$64

T2300 SERIES, EL2424-H, EL2427-H, EL2436 & EL2448

11" x 22" rectangular (3/4" thick)

(H-X-2211/00) \$62

EFL2026

10" x 24" rectangular (3/4" thick)

(H-X-2410/00) \$62

EFL2626, EFL2635

12" x 24" rectangular (3/4" thick)

(H-X-2412/00) \$64

EL2848, EFL1616, EFL1626

14" x 24" rectangular (3/4" thick)

(H-X-2414/00) \$76

X3200 SERIES, T3400 SERIES & EL3048

28" x 14" rectangular (3/4" thick)

(H-X-2814/00) \$82

SIGNATURE L&L FEATURES

HARD CERAMIC ELEMENT HOLDERS - KEY TO L&L'S DURABILITY

The smooth, hard surface of the inside ceramic channel allows the elements to expand and contract freely. No pins! This prevents catastrophic element failure. Elements do not droop out of broken firebrick channels. The dense ceramic DynaGlow holders extend element life because they do not insulate the hot elements from the kiln interior.

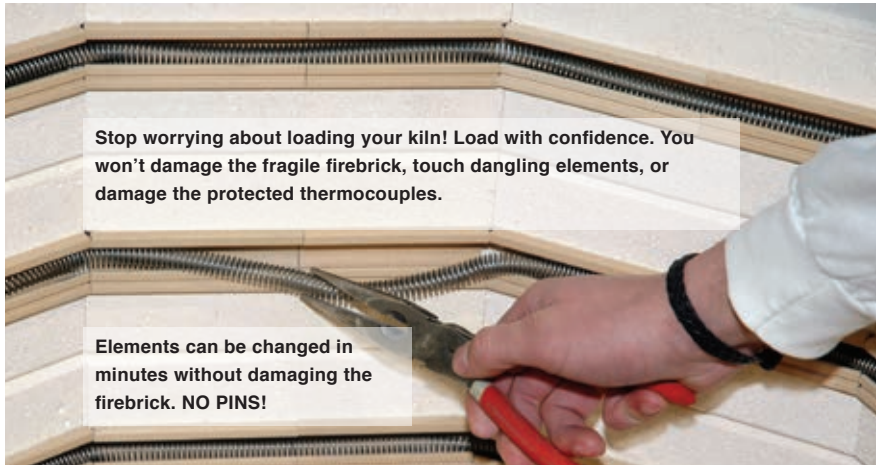

OTHER DURABILITY FEATURES

PROTECTED THERMOCOUPLES

L&L thermocouples are shielded from corrosion by a ceramic protection tube. We use the finest "special limit" aerospace-grade heavy-gauge thermocouple wire. The protection tube prevents black dust from the thermocouple end from discolouring your work. (hotkilns.com/tc-protection)



CERAMIC ELEMENT TERMINALS

Ceramic element terminals make element changes easy. (hotkilns.com/ceramic-terminal)



SOLID PEEP PLUGS

Solid straight ceramic peephole plugs are strong and will not slip out like tapered, fragile, slip-cast plugs. (hotkilns.com/peephole-plugs)



CORROSION RESISTANCE

Stainless steel, aluminized, and galvanealed steel are used where needed. All other metal is powder-coated which also resists corrosion. (hotkilns.com/corrosion-resistant)

PROPRIETARY BRICK COATING

L&L's proprietary reflective brick coating protects the surface of the firebrick and keeps dusting down inside the kiln. (hotkilns.com/reflective-coating)

LID BRICK IS SECURED WITH CLIPS

Stainless "U" brackets secure lids - not friction. (hotkilns.com/lid-clips)

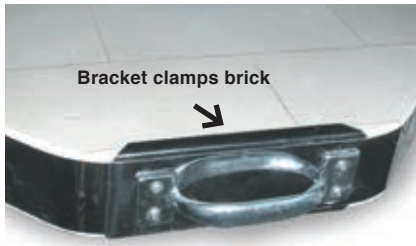

FULL-SUPPORT STANDS

On all polygonal kilns we use a Full-support 14 gauge aluminized steel stand is stronger than hollow frame stands and provides important support in the center of the bottom. (hotkilns.com/full-stand)

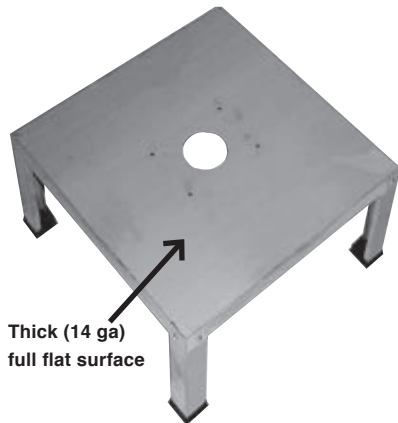

PERFORMANCE

DYNATROL IS EASY AND POWERFUL



DynaTrol with 4 Easy-Fire programs (Slow Bisque, Fast Bisque, Slow Glaze, Fast Glaze), 6 custom programs, PreHeat, Delay, Program, Segment Review, and Diagnostics. (hotkilns.com/dynatrol) Also see optional controls on page 27.

DYNAMIC ZONE CONTROL

The DynaTrol separately measures temperatures in the bottom, middle and top of the kiln and automatically adjusts the heat output of three zones during the entire firing. Kiln temperatures are automatically evened out to within 1/2 cone or better top to bottom. Zone control automatically compensates for many loading issues and element changes over time. Even on kilns where we use graded elements, L&L kilns are fundamentally uniform because the element holders radiate the heat more evenly. (hotkilns.com/zone)

"EASY-OPEN, EASY-LOAD" LID OPENS WIDE FOR LOADING

The whole kiln supports the lid (not just one section). Our positive safety pin secures the lid safely. No support bars (like other kilns) get in the way of loading when the lid is fully tilted back. (hotkilns.com/spring-hinge)



SAFETY

UL499 LISTING

Most L&L kilns are c-MET-us listed to UL499 standards. See each kiln series for details. (hotkilns.com/ul499)



SAFE MATERIALS

No asbestos, mercury, lead, or other hazardous materials are used in L&L kilns.

SAFETY LATCHES ON LIDS

All lids and lifting devices include a safety latching system. On/Off & safety switches.

MAINTAINABILITY

L&L KILNS ARE EASY TO TROUBLESHOOT

Open up any L&L kiln control panel and see how easy it is to check amps, element resistance, and voltage. No other kiln can be serviced as quickly, easily, or inexpensively as an L&L kiln.

SECTIONAL CONSTRUCTION MAKES REPAIR WORK EASY

All top-loading L&L kilns are sectional. Even the large 35 cubic foot standard DaVinci kiln is easy to move, set up, and repair.

THREE-YEAR WARRANTY

See hotkilns.com/warranty. Free email, web and phone support forever.

IN-DEPTH SUPPORT

One customer said: "I am truly impressed with your website, it is more than informative and your products are well designed. The fact that all the information, including repair manuals, are listed, speaks well of your dedication to customer service." Our website has thousands of pages of technical help - all easily searchable - plus we provide expert free support with phone and email.



VISUAL INSTRUCTIONS

No one has a better or more complete instruction manual. Our visual instructions address the needs of the artist, the installer, and the repair person. You get a fully illustrated operation and service manual. Various instructional videos are available. (hotkilns.com/videos)

WHAT L&L CUSTOMERS SAY



BILL CAMPBELL

"I make a living out of my five L&L kilns. I really beat them up, firing them at least three times a week to Cone 10. They take a real beating and keep on going."

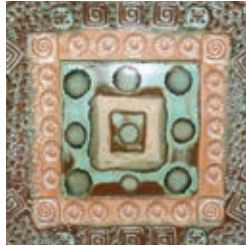

DIANE EMERSON

"I switched to L&L because of the deterioration of the element channels in my last kiln. I load larger tiles and I need the extra durability on the face of the firebrick."



FRANK GIORGINI

"My original L&L (J2927) has provided outstanding service and reliability through the firing of countless pots, tiles, udu drums, sculptures and two New York City MTA Subway projects. It's still in service right next to my DaVinci kiln."



More Information & Support at hotkilns.com

Prices in this catalog are subject to change without notice. Prices are always current on our web site. Find complete specifications, support videos, photos, parts, PDF Library, and thousands of pages of knowledgebase information easily, using our sophisticated search engine.



505 Sharptown Road • Swedesboro, NJ 08085
 Phone: 856.294.0077 • Fax: 856.294.0070
 sales@hotkilns.com • hotkilns.com

KILNS BUILT TO LAST

Prices Effective January 1, 2019 Bulletin No: CAT-1-19A